

CMPD6263
 CMPD6263A
 CMPD6263C
 CMPD6263S

**SURFACE MOUNT SILICON
 SCHOTTKY DIODES**



www.centrasemi.com

DESCRIPTION:

The CENTRAL SEMICONDUCTOR CMPD6263 series devices are silicon Schottky diodes designed for low current surface mount fast switching applications requiring a low forward voltage drop.



SOT-23 CASE

The following configurations are available:

CMPD6263 SINGLE
 CMPD6263A DUAL, COMMON ANODE
 CMPD6263C DUAL, COMMON CATHODE
 CMPD6263S DUAL, IN SERIES

MARKING CODE: D76

MARKING CODE: D98

MARKING CODE: D97

MARKING CODE: D96

MAXIMUM RATINGS: ($T_A=25^\circ\text{C}$)

Peak Repetitive Reverse Voltage
 Continuous Forward Current
 Peak Forward Surge Current, $t_p=1.0\text{s}$
 Power Dissipation
 Operating and Storage Junction Temperature
 Thermal Resistance

SYMBOL

V_{RRM} 70
 I_F 15
 I_{FSM} 50
 P_D 350
 T_J, T_{stg} -65 to +150
 θ_{JA} 357

UNITS

V
 mA
 mA
 mW
 $^\circ\text{C}$
 $^\circ\text{C/W}$

ELECTRICAL CHARACTERISTICS PER DIODE: ($T_A=25^\circ\text{C}$ unless otherwise noted)

SYMBOL	TEST CONDITIONS	MIN	TYP	MAX	UNITS
I_R	$V_R=50\text{V}$		10	200	nA
BV_R	$I_R=10\mu\text{A}$	70			V
V_F	$I_F=1.0\text{mA}$		395	410	mV
C_J	$V_R=0, f=1.0\text{MHz}$			2.0	pF

R7 (11-December 2015)

CMPD6263
 CMPD6263A
 CMPD6263C
 CMPD6263S

**SURFACE MOUNT SILICON
 SCHOTTKY DIODES**



SOT-23 CASE - MECHANICAL OUTLINE

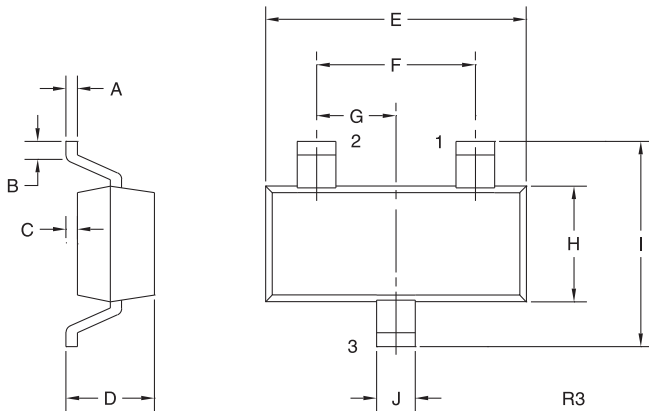

SYMBOL	INCHES		MILLIMETERS	
	MIN	MAX	MIN	MAX
A	0.003	0.007	0.08	0.18
B	0.006	-	0.15	-
C	-	0.005	-	0.13
D	0.035	0.043	0.89	1.09
E	0.110	0.120	2.80	3.05
F	0.075		1.90	
G	0.037		0.95	
H	0.047	0.055	1.19	1.40
I	0.083	0.098	2.10	2.49
J	0.014	0.020	0.35	0.50

SOT-23 (REV: R3)

PIN CONFIGURATIONS

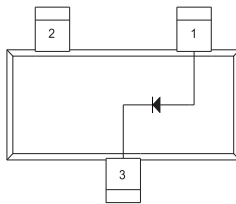

CMPD6263

LEAD CODE:

- 1) Anode
- 2) No Connection
- 3) Cathode

MARKING CODE: D76

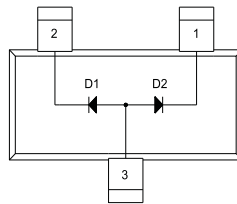

CMPD6263A

LEAD CODE:

- 1) Cathode D2
- 2) Cathode D1
- 3) Anode D1, D2

MARKING CODE: D98

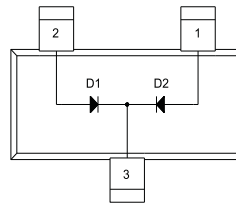

CMPD6263C

LEAD CODE:

- 1) Anode D2
- 2) Anode D1
- 3) Cathode D1, D2

MARKING CODE: D97

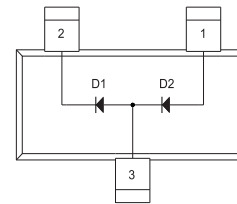

CMPD6263S

LEAD CODE:

- 1) Anode D2
- 2) Cathode D1
- 3) Anode D1, Cathode D2

MARKING CODE: D96

R7 (11-December 2015)

www.centalsemi.com

CMPD6263
 CMPD6263A
 CMPD6263C
 CMPD6263S



SURFACE MOUNT SILICON
 SCHOTTKY DIODES

TYPICAL ELECTRICAL CHARACTERISTICS

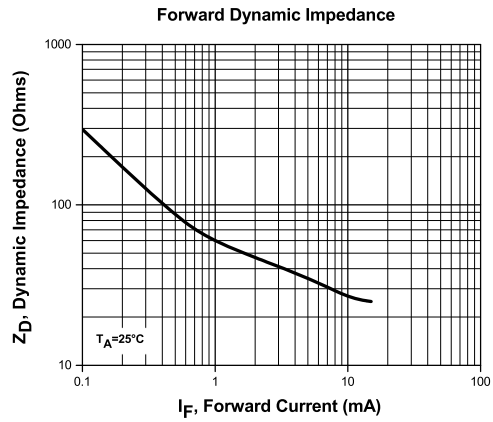
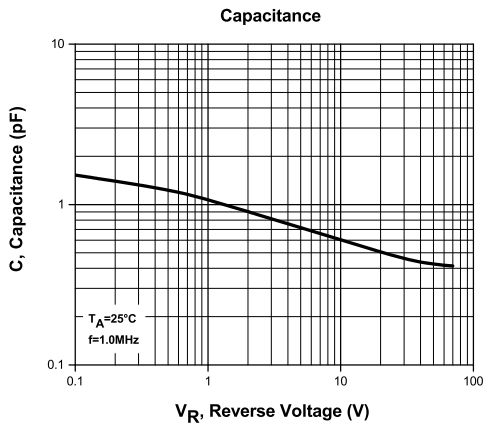
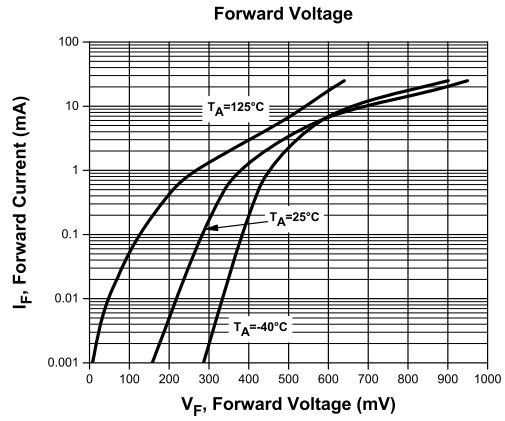
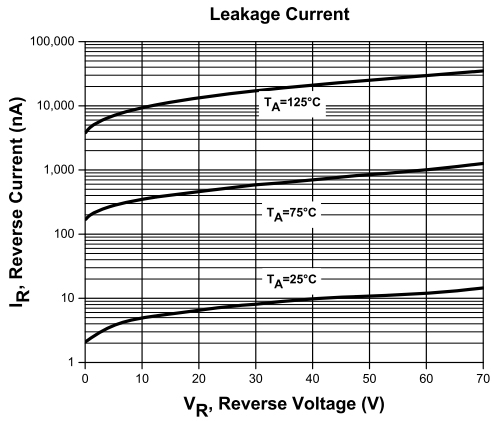

R7 (11-December 2015)

www.centrasemi.com

CMPD6263
CMPD6263A
CMPD6263C
CMPD6263S

SURFACE MOUNT SILICON
SCHOTTKY DIODES



TYPICAL ELECTRICAL CHARACTERISTICS

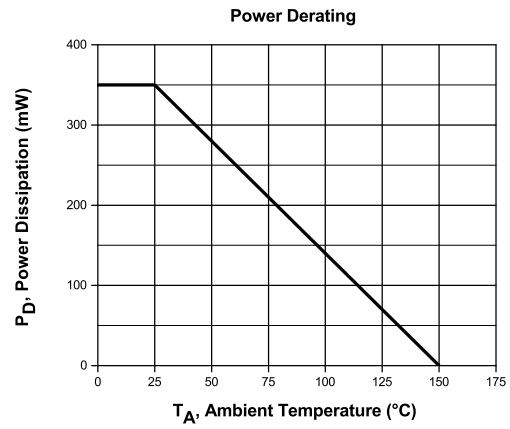
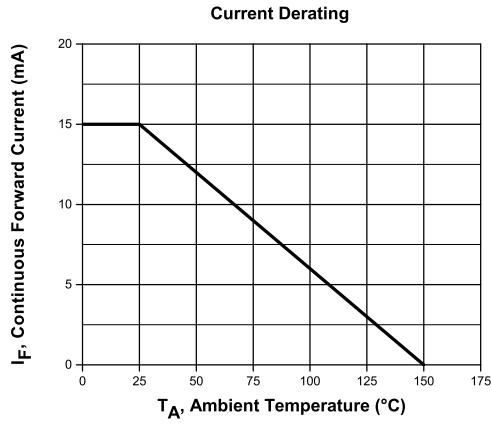

R7 (11-December 2015)

www.centrasemi.com



OUTSTANDING SUPPORT AND SUPERIOR SERVICES

PRODUCT SUPPORT

Central's operations team provides the highest level of support to insure product is delivered on-time.

- Supply management (Customer portals)
- Inventory bonding
- Consolidated shipping options
- Custom bar coding for shipments
- Custom product packing

DESIGNER SUPPORT/SERVICES

Central's applications engineering team is ready to discuss your design challenges. Just ask.

- Free quick ship samples (2nd day air)
- Online technical data and parametric search
- SPICE models
- Custom electrical curves
- Environmental regulation compliance
- Customer specific screening
- Up-screening capabilities
- Special wafer diffusions
- PbSn plating options
- Package details
- Application notes
- Application and design sample kits
- Custom product and package development

REQUESTING PRODUCT PLATING

1. If requesting Tin/Lead plated devices, add the suffix "TIN/LEAD" to the part number when ordering (example: 2N2222A TIN/LEAD).
2. If requesting Lead (Pb) Free plated devices, add the suffix "PBFREE" to the part number when ordering (example: 2N2222A PBFREE).

CONTACT US

Corporate Headquarters & Customer Support Team

Central Semiconductor Corp.
145 Adams Avenue
Hauppauge, NY 11788 USA
Main Tel: (631) 435-1110
Main Fax: (631) 435-1824
Support Team Fax: (631) 435-3388
www.centrasemi.com

Worldwide Field Representatives:
www.centrasemi.com/wwreps

Worldwide Distributors:
www.centrasemi.com/wwdistributors

For the latest version of Central Semiconductor's **LIMITATIONS AND DAMAGES DISCLAIMER**, which is part of Central's Standard Terms and Conditions of sale, visit: www.centrasemi.com/terms