

EAO – Your Expert Partner for
Human Machine Interfaces

Switches Unlimited
Contact: sales@switchesunlimited.com
Phone: 800-221-0487 * Fax: 718-672-6370
www.switchesunlimited.com

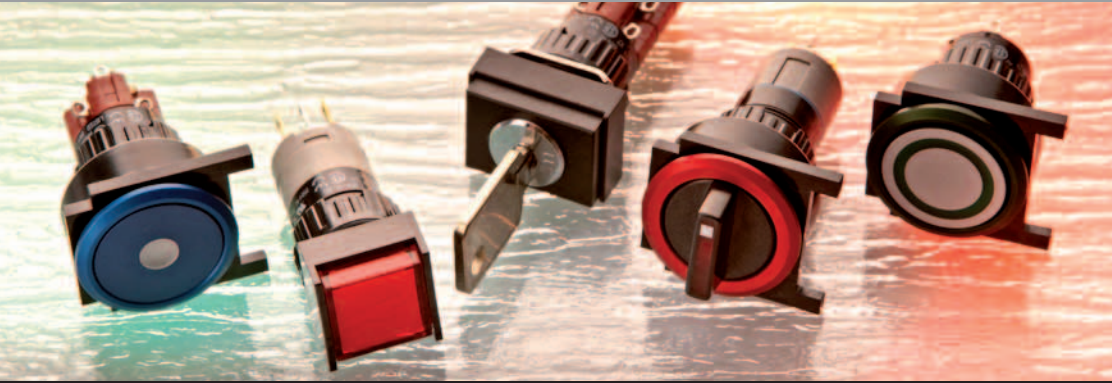

EAO Product Information

Series 51

eao ■

| | |
|-------------------------------|----|
| Description | 3 |
| Product Assembly | 4 |
| Devices raised mounting | 7 |
| Devices flush mounting | 13 |
| Accessories..... | 21 |
| Technical Data..... | 33 |
| Typical Applications | 36 |
| Application guidelines..... | 37 |
| Marking | 38 |
| Drawings..... | 40 |
| Index..... | 58 |

Product Information

General notes

The illuminated pushbuttons of series 51 with hoseproof front (IP 65) can be supplied with snap-action or low-level switching elements. The equipment (switches) for raised mounting are protected against accidental operation by the extended sides of the bezel. Flush mounting equipment excels with best available ergonomics and low down height. To supplement the range of illuminated pushbuttons, we can offer a hoseproof safety keylock switch with various lock numbers.

Mounting

All switch actuators are mounted from the front by pushing them through the mounting hole in the front panel. They are then fixed from the back with a fixing nut and the mounting tool Typ-Nr. 01-907. Max. tightening torque 50 Ncm.

For switching elements we offer plug-in bases, which when soldered to a PCB enable a plug-in connection to the button. The rectangular actuators for raised are provided with an anti-twisting device.

Lenses

The flat or concave lenses are available in various colours, as well as translucent or transparent. Round lenses for flush mounting equipment are available in aluminium also.

Because of production related reasons, the colours of anodized aluminium parts can vary slightly.

Marking

For further information about engraving, hot stamping and film inserts see part Marking.

Illumination

The T1 ³/₄ Midget Groove incandescent (filament) lamp (6 ... 48 V) ensures perfect illumination of the lenses, which are supplied in various colours.

T1 ³/₄ Midget Groove Single-LED (6, 12, 24, 28, 48 V) are also available in blue, green, red, white or yellow.

Luminosity and wave length scattering caused by technologie used in the LED manufacturing processes may lead to visual differences in our products.

For supply voltages above 48 V, it is necessary to use a voltage reduction element (external series resistor or transformer).

Position indication

The status of a maintained action switch can be determined by the position of the lens.

Keylock switch

Standard lock (Index D). Standard lock number is 311. If the lock number is not specified, we will supply standard number 311.

An additional 134 special locks (Index X) are available on request. Master keys for lock numbers 311 ... 445 may be ordered by quoting Typ-Nr. 31-989.300. Two keys are supplied with each keylock switch. Spare keys (Index D) for standard locks may be ordered by quoting Typ-Nr. 31-989.xxx (please state the lock number).

Specimen order

Indicator :

- Indicator actuator, 18 x 24 mm, soldering terminal 31-040.005

Essential accessories :

- Lens plastic blue, transparent, flush, 18 x 24 mm 31-903.6
- Single-LED, T1 ³/₄ MG, 24 VAC/DC, blau 10-2J12.1066

*We reserve the right to modify technical data
All dimensions in mm*

Indicator round, raised mounting

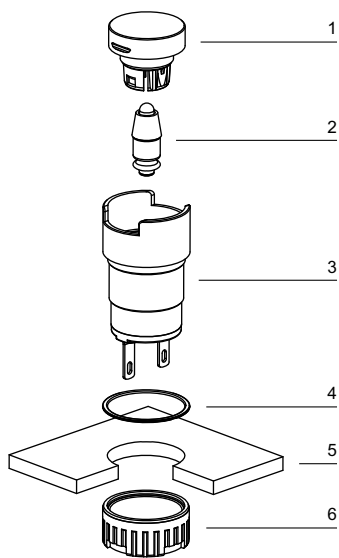

- 1 Lens
- 2 LED
- 3 Indicator housing
- 4 Sealing
- 5 Front plate
- 6 Fixing nut

Illuminated pushbutton, raised mounting

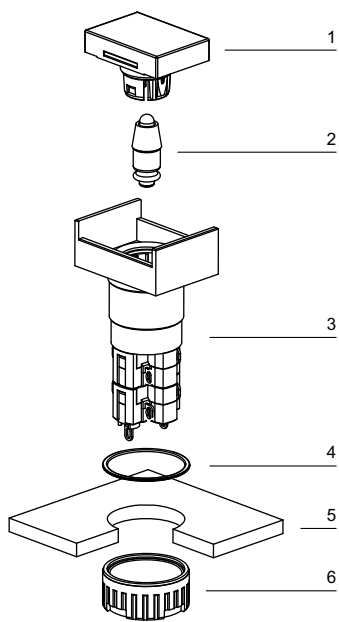

- 1 Lens
- 2 LED
- 3 Switch housing
- 4 Sealing
- 5 Front plate
- 6 Fixing nut

Keylock switch round, flush mounting

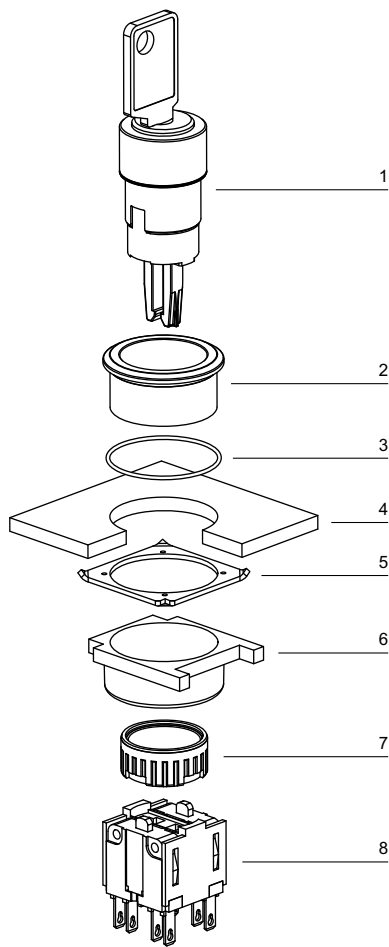

- 1 Actuator housing
- 2 Front bezel
- 3 Sealing
- 4 Front plate
- 5 Anti-twist ring
- 6 Thrust piece
- 7 Fixing nut
- 8 Switching element

Selector switch square, flush mounting

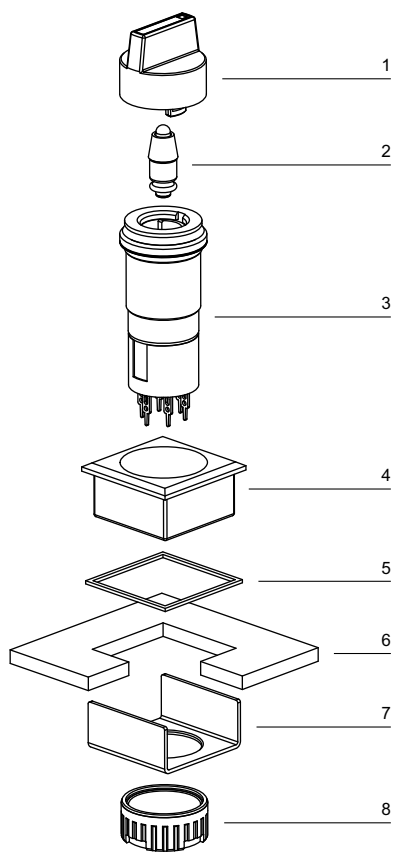



- 1 Actuator housing
- 2 LED
- 3 Actuator housing
- 4 Front bezel
- 5 Sealing
- 6 Front plate
- 7 Fixing bracket
- 8 Fixing nut

Indicator actuator



Essential Accessories:

-  Lens plastic, raised mounting page 21
-  Single-LED page 30

| | Front protection | Diode (1N 4007) | Terminals | ⌀ 18 x 18 mm Typ-Nr. | ⌀ 18 x 24 mm Typ-Nr. | Ø 18 mm Typ-Nr. | Component layout | Mounting dimensions | Technical drawing | Circuit drawing |  |
|---------------------------|------------------|-----------------|-----------|-------------------------|-------------------------|--------------------|------------------|---------------------|-------------------|-----------------|---|
| Indicator actuator | IP 65 | 1 D | UT | 51-703.006 | 51-701.006 | 51-741.006 | 4 | 1 | 12 | 78 | 0.006 |
| | | 2 D | UT | 51-704.006 | 51-702.006 | 51-742.006 | 4 | 1 | 12 | 79 | 0.006 |
| | - | S | | 51-050.005 | 51-040.005 | 51-030.005 | | 1 | 12 | 1 | 0.004 |
| | | S1 | | 51-050.002 | 51-040.002 | 51-030.002 | | 1 | 12 | 1 | 0.004 |
| | | UT | | 51-051.006 | 51-041.006 | 51-031.006 | 4 | 1 | 12 | 1 | 0.005 |

Indicators fit also in mounting hole no. 2

Diode (1N 4007): D = Diode, - = without



Terminals: UT = Universal terminal, S = Soldering terminal, S1 = Soldering terminal (also pluggable 2.8 x 0.5 mm)

Component layout from page 40, Mounting dimensions from page 41, Technical drawing from page 42, Circuit drawing from page 47

Illuminated pushbutton actuator



Essential Accessories:

-  Lens plastic, raised mounting page 21
-  Single-LED page 30

| | Front protection | Switching system | Contacts | Diode (1N 4007) | Switching action | Terminals | ∅ 18 x 18 mm Typ-Nr. | ∅ 18 x 24 mm Typ-Nr. | ∅ 18 mm Typ-Nr. | Component layout | Mounting dimensions | Technical drawing | Circuit drawing | | |
|--|------------------|------------------|-------------|-----------------|------------------|-------------|-------------------------|-------------------------|--------------------|------------------|---------------------|-------------------|-----------------|-------|-------|
| Illuminated pushbutton actuator | IP 65 | LL | 1 NC | - | MA | UT | 51-486.036 | 51-466.036 | 51-476.036 | 4 | 1 | 13 | 11 | 0.007 | |
| | | | | | M | UT | 51-456.036 | 51-426.036 | 51-436.036 | 4 | 1 | 13 | 57 | 0.007 | |
| | | | 1 NC + 1 NO | - | MA | UT | 51-483.036 | 51-463.036 | 51-473.036 | 4 | 1 | 13 | 14 | 0.007 | |
| | | | | | M | UT | 51-453.036 | 51-423.036 | 51-433.036 | 4 | 1 | 13 | 60 | 0.007 | |
| | | | 1 NO | - | MA | UT | 51-485.036 | 51-465.036 | 51-475.036 | 4 | 1 | 13 | 13 | 0.007 | |
| | | | | | M | UT | 51-455.036 | 51-425.036 | 51-435.036 | 4 | 1 | 13 | 59 | 0.007 | |
| | | | 2 NC | - | MA | UT | 51-482.036 | 51-462.036 | 51-472.036 | 4 | 1 | 13 | 12 | 0.007 | |
| | | | | | M | UT | 51-452.036 | 51-422.036 | 51-432.036 | 4 | 1 | 13 | 58 | 0.007 | |
| | | | 2 NO | - | MA | UT | 51-481.036 | 51-461.036 | 51-471.036 | 4 | 1 | 13 | 15 | 0.007 | |
| | | | | | M | UT | 51-451.036 | 51-421.036 | 51-431.036 | 4 | 1 | 13 | 61 | 0.007 | |
| | | | SA | 1 NC + 1 NO | 1 D | MA | H | 51-717.0292 | 51-713.0292 | 51-747.0292 | | 1 | 13 | 8 | 0.008 |
| | | | | | | M | H | 51-709.0292 | 51-705.0292 | 51-743.0292 | | 1 | 13 | 54 | 0.008 |
| | | 2 D | | | MA | H | 51-718.0292 | 51-714.0292 | 51-748.0292 | | 1 | 13 | 9 | 0.008 | |
| | | | | | M | H | 51-710.0292 | 51-706.0292 | 51-744.0292 | | 1 | 13 | 55 | 0.008 | |
| | | - | | | MA | S | 51-281.0252 | 51-261.0252 | 51-271.0252 | | 1 | 13 | 10 | 0.006 | |
| | | | | | | S1 | 51-281.022 | 51-261.022 | 51-271.022 | | 1 | 13 | 7 | 0.006 | |
| | | | | | M | S | 51-151.0252 | 51-121.0252 | 51-131.0252 | | 1 | 13 | 56 | 0.006 | |
| | | | | | | S1 | 51-151.022 | 51-121.022 | 51-131.022 | | 1 | 13 | 53 | 0.006 | |
| | | 2 NC + 2 NO | | | 1 D | MA | H | 51-719.0292 | 51-715.0292 | 51-749.0292 | | 1 | 13 | 4 | 0.010 |
| | | | | | | M | H | 51-711.0292 | 51-707.0292 | 51-745.0292 | | 1 | 13 | 50 | 0.010 |
| | | | | | 2 D | MA | H | 51-720.0292 | 51-716.0292 | 51-750.0292 | | 1 | 13 | 5 | 0.010 |
| | | | | | | M | H | 51-712.0292 | 51-708.0292 | 51-746.0292 | | 1 | 13 | 51 | 0.010 |
| | | | - | MA | S | 51-282.0252 | 51-262.0252 | 51-272.0252 | | 1 | 13 | 6 | 0.008 | | |
| | | | | M | S | 51-152.0252 | 51-122.0252 | 51-132.0252 | | 1 | 13 | 52 | 0.008 | | |
| 3 NC + 3 NO | - | MA | S | 51-283.0252 | 51-263.0252 | 51-273.0252 | | 1 | 13 | 3 | 0.010 | | | | |
| | | M | S | 51-153.0252 | 51-123.0252 | 51-133.0252 | | 1 | 13 | 49 | 0.010 | | | | |
| 4 NC + 4 NO | - | MA | S | 51-284.0252 | 51-264.0252 | 51-274.0252 | | 1 | 13 | 2 | 0.012 | | | | |
| | | M | S | 51-154.0252 | 51-124.0252 | 51-134.0252 | | 1 | 13 | 48 | 0.012 | | | | |

Illuminated pushbutton fit also in mounting hole no. 2

Switching system: LL = Low level switching element, SA = Snap-action switching element

Contacts: NC = Normally closed, NO = Normally open

Diode (1N 4007): - = without, D = Diode

Switching action: MA = Maintained action, M = Momentary action

Terminals: UT = Universal terminal, H = Combined terminal: Solder-/ Universal (at contact/ at diode), S = Soldering terminal, S1 = Soldering terminal (also pluggable 2.8 x 0.5 mm)

Component layout from page 40, Mounting dimensions from page 41, Technical drawing from page 42, Circuit drawing from page 47

Keylock switch 2 positions

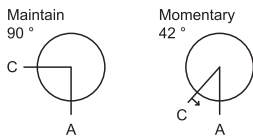

| | Front protection | Switching system | Contacts | Switching action | Terminals | Key remove | Key remove | | | Component layout | Mounting dimensions | Technical drawing | Circuit drawing | IP |
|--|------------------|------------------|-------------|------------------|--------------|--------------|-------------------------|-------------------------|--------------------|------------------|---------------------|-------------------|-----------------|-------|
| | | | | | | | Ø 18 x 18 mm Typ-Nr. | Ø 18 x 24 mm Typ-Nr. | Ø 18 mm Typ-Nr. | | | | | |
| Keylock switch 2 positions Position A : Basic position Position C : Maintained action Standard lock 311 Front : Plastic black | IP 65 | LL | 1 NC + 1 NO | MA | UT | A | 51-445.036D | 51-405.036D | 51-415.036D | 4 | 2 | 14 | 76 | 0.017 |
| | | | | | | C | 51-448.036D | 51-408.036D | 51-418.036D | 4 | 2 | 14 | 76 | 0.017 |
| | | | | | | C + A | 51-442.036D | 51-402.036D | 51-412.036D | 4 | 2 | 14 | 76 | 0.017 |
| | | | | | | | | | | | | | | |
| | | | 2 NO | MA | UT | A | 51-444.036D | 51-404.036D | 51-414.036D | 4 | 2 | 14 | 77 | 0.017 |
| | | | | | | C | 51-447.036D | 51-407.036D | 51-417.036D | 4 | 2 | 14 | 77 | 0.017 |
| | | | | | | C + A | 51-441.036D | 51-401.036D | 51-411.036D | 4 | 2 | 14 | 77 | 0.017 |
| | | | | | | | | | | | | | | |
| | | SA | 1 NC + 1 NO | MA | S | A | 51-255.025D2 | 51-295.025D2 | 51-235.025D2 | 2 | 14 | 72 | 0.016 | |
| | | | | | | C | 51-355.025D2 | 51-395.025D2 | 51-335.025D2 | 2 | 14 | 72 | 0.016 | |
| | | | | | | C + A | 51-155.025D2 | 51-195.025D2 | 51-135.025D2 | 2 | 14 | 72 | 0.016 | |
| | | | | | | S1 | A | 51-255.022D | 51-295.022D | 51-235.022D | 2 | 14 | 72 | 0.016 |
| | | | | | | C | 51-355.022D | 51-395.022D | 51-335.022D | 2 | 14 | 72 | 0.016 | |
| | | | | | | C + A | 51-155.022D | 51-195.022D | 51-135.022D | 2 | 14 | 72 | 0.016 | |
| | | | | 2 NC + 2 NO | MA | S | A | 51-256.025D2 | 51-296.025D2 | 51-236.025D2 | 2 | 14 | 73 | 0.016 |
| | | | | | | | C | 51-356.025D2 | 51-396.025D2 | 51-336.025D2 | 2 | 14 | 73 | 0.016 |
| C + A | 51-156.025D2 | | | | | | 51-196.025D2 | 51-136.025D2 | 2 | 14 | 73 | 0.016 | | |
| A | 51-257.025D2 | | | | | | 51-297.025D2 | 51-237.025D2 | 2 | 14 | 74 | 0.016 | | |
| C | 51-357.025D2 | | | | | | 51-397.025D2 | 51-337.025D2 | 2 | 14 | 74 | 0.016 | | |
| C + A | 51-157.025D2 | | | | | | 51-197.025D2 | 51-137.025D2 | 2 | 14 | 74 | 0.016 | | |
| 4 NC + 4 NO | MA | S | A | 51-258.025D2 | 51-298.025D2 | 51-238.025D2 | 2 | 14 | 75 | 0.016 | | | | |
| | | | C | 51-358.025D2 | 51-398.025D2 | 51-338.025D2 | 2 | 14 | 75 | 0.016 | | | | |
| | | | C + A | 51-158.025D2 | 51-198.025D2 | 51-138.025D2 | 2 | 14 | 75 | 0.016 | | | | |
| | | | A | 51-458.036D | 51-428.036D | 51-438.036D | 4 | 2 | 14 | 70 | 0.017 | | | |
| | | | C | 51-457.036D | 51-427.036D | 51-437.036D | 4 | 2 | 14 | 71 | 0.017 | | | |
| | | | C + A | 51-145.025D2 | 51-495.025D2 | 51-141.025D2 | 2 | 14 | 66 | 0.016 | | | | |
| SA | 1 NC + 1 NO | M | S | A | 51-145.022D | 51-495.022D | 51-141.022D | 2 | 14 | 66 | 0.016 | | | |
| | | | | C | 51-146.025D2 | 51-496.025D2 | 51-142.025D2 | 2 | 14 | 67 | 0.016 | | | |
| | | | | C | 51-147.025D2 | 51-497.025D2 | 51-143.025D2 | 2 | 14 | 68 | 0.016 | | | |
| | | | | C | 51-148.025D2 | 51-498.025D2 | 51-144.025D2 | 2 | 14 | 69 | 0.016 | | | |

Other lock numbers on request

Switching system: LL = Low level switching element, SA = Snap-action switching element

Contacts: NC = Normally closed, NO = Normally open

Switching action: MA = Maintained action, M = Momentary action

Terminals: UT = Universal terminal, S = Soldering terminal, S1 = Soldering terminal (also pluggable 2.8 x 0.5 mm)

Component layout from page 40, Mounting dimensions from page 41, Technical drawing from page 42, Circuit drawing from page 47

Keylock switch 3 positions

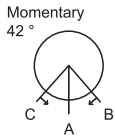
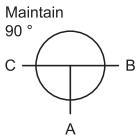

| | Front protection | Switching system | Contacts | Switching action | Terminals | Key remove | Ø 18 x 18 mm Typ-Nr. | Ø 18 x 24 mm Typ-Nr. | Ø 18 mm Typ-Nr. | Mounting dimensions | Technical drawing | Circuit drawing | |
|---|------------------|------------------|-------------|------------------|-----------|------------|-------------------------|-------------------------|--------------------|---------------------|-------------------|-----------------|-------|
| Keylock switch 3 positions Position C : Maintained action Position A : Basic position Position B : Maintained action Standard lock 311 | IP 65 | SA | 2 NC + 2 NO | MA-0-MA | S1 | A | 51-381.022D | 51-361.022D | 51-371.022D | 2 | 1 | 65 | 0.025 |
| | | | | | | C + B | 51-383.022D | 51-363.022D | 51-373.022D | 2 | 1 | 65 | 0.025 |
| | | | | | | C+A+B | 51-382.022D | 51-362.022D | 51-372.022D | 2 | 1 | 65 | 0.025 |
| Position C : Maintained action Position A : Basic position Position B : Momentary action Standard lock 311 | IP 65 | SA | 2 NC + 2 NO | MA-0-M | S1 | A | 51-385.022D | 51-365.022D | 51-375.022D | 2 | 1 | 64 | 0.025 |
| | | | | | | C + A | 51-386.022D | 51-366.022D | 51-376.022D | 2 | 1 | 64 | 0.025 |
| Position C : Momentary action Position A : Basic position Position B : Momentary action Standard lock 311 | IP 65 | SA | 2 NC + 2 NO | M-0-M | S1 | A | 51-384.022D | 51-364.022D | 51-374.022D | 2 | 1 | 63 | 0.025 |
| Position C : Momentary action Position A : Basic position Position B : Maintained action standard lock 311 | IP 65 | SA | 2 NC + 2 NO | M-0-MA | S1 | A | 51-387.022D | 51-367.022D | 51-377.022D | 2 | 1 | 62 | 0.025 |
| | | | | | | A + B | 51-388.022D | 51-368.022D | 51-378.022D | 2 | 1 | 62 | 0.025 |

Other lock numbers on request

Switching system: SA = Snap-action switching element

Contacts: NC = Normally closed, NO = Normally open

Switching action: MA = Maintained action, M = Momentary action

Terminals: S1 = Soldering terminal (also pluggable 2.8 x 0.5 mm)

Mounting dimensions from page 41, Technical drawing from page 42, Circuit drawing from page 47

Selector switch 2 positions

illuminative



Essential Accessories:

- Lever, raised mounting page 24
- Single-LED page 30

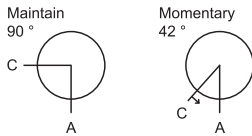

| | Front protection | Switching system | Contacts | Diode (1N 4007) | Switching action | Terminals | Ø 18 mm Typ-Nr. | Component layout | Mounting dimensions | Technical drawing | Circuit drawing | |
|---|------------------|------------------|-------------|-----------------|-------------------|-----------|--------------------|------------------|---------------------|-------------------|-----------------|--|
| Selector switch 2 positions Position A : Basic position Position C : Maintained action | IP 65 | LL | 1 NC | - | MA | UT | 52-476.036 | 4 2 | 19 43 | 0.007 | | |
| | | | 1 NC + 1 NO | - | MA | UT | 52-473.036 | 4 2 | 19 46 | 0.007 | | |
| | | | 1 NO | - | MA | UT | 52-475.036 | 4 2 | 19 45 | 0.007 | | |
| | | | 2 NC | - | MA | UT | 52-472.036 | 4 2 | 19 44 | 0.007 | | |
| | | | 2 NO | - | MA | UT | 52-471.036 | 4 2 | 19 47 | 0.007 | | |
| | | SA | 1 NC + 1 NO | 1 D | MA | H | 52-747.0292 | | 2 19 | 40 0.008 | | |
| | | | | 2 D | MA | H | 52-748.0292 | | 2 19 | 41 0.008 | | |
| | | | | - | MA | S | 52-271.0252 | | 2 19 | 42 0.006 | | |
| | | | | S1 | 52-271.022 | | 2 19 | 39 0.006 | | | | |
| | | | 2 NC + 2 NO | 1 D | MA | H | 52-749.0292 | | 2 19 | 36 0.010 | | |
| | | | | 2 D | MA | H | 52-750.0292 | | 2 19 | 37 0.010 | | |
| | | | | - | MA | S | 52-272.0252 | | 2 19 | 38 0.006 | | |
| | | | 3 NC + 3 NO | - | MA | S | 52-273.0252 | | 2 19 | 35 0.006 | | |
| | | | 4 NC + 4 NO | - | MA | S | 52-274.0252 | | 2 19 | 34 0.006 | | |
| Position A : Basic position Position C : Momentary action | IP 65 | LL | 1 NC | - | M | UT | 52-436.036 | 4 2 | 19 29 | 0.007 | | |
| | | | 1 NC + 1 NO | - | M | UT | 52-433.036 | 4 2 | 19 32 | 0.007 | | |
| | | | 1 NO | - | M | UT | 52-435.036 | 4 2 | 19 31 | 0.007 | | |
| | | | 2 NC | - | M | UT | 52-432.036 | 4 2 | 19 30 | 0.007 | | |
| | | | 2 NO | - | M | UT | 52-431.036 | 4 2 | 19 33 | 0.007 | | |
| | | SA | 1 NC + 1 NO | 1 D | M | H | 52-743.0292 | | 2 19 | 26 0.008 | | |
| | | | | 2 D | M | H | 52-744.0292 | | 2 19 | 27 0.008 | | |
| | | | | - | M | S | 52-131.0252 | | 2 19 | 28 0.006 | | |
| | | | | S1 | 52-131.022 | | 2 19 | 25 0.006 | | | | |
| | | | 2 NC + 2 NO | 1 D | M | H | 52-745.0292 | | 2 19 | 22 0.010 | | |
| | | | | 2 D | M | H | 52-746.0292 | | 2 19 | 23 0.010 | | |
| | | | | - | M | S | 52-132.0252 | | 2 19 | 24 0.006 | | |
| | | | 3 NC + 3 NO | - | M | S | 52-133.0252 | | 2 19 | 21 0.006 | | |
| | | | 4 NC + 4 NO | - | M | S | 52-134.0252 | | 2 19 | 20 0.006 | | |

Switching system: LL = Low level switching element, SA = Snap-action switching element

Contacts: NC = Normally closed, NO = Normally open

Diode (1N 4007): - = without, D = Diode

Switching action: MA = Maintained action, M = Momentary action

Terminals: UT = Universal terminal, H = Combined terminal: Solder-/ Universal (at contact/ at diode), S = Soldering terminal, S1 = Soldering terminal (also pluggable 2.8 x 0.5 mm)



Component layout from page 40, Mounting dimensions from page 41, Technical drawing from page 42, Circuit drawing from page 47

Selector switch 3 positions

illuminative



Essential Accessories:

-  Lever, raised mounting page 24
-  Single-LED page 30

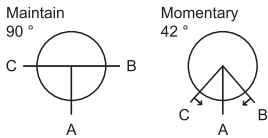

| | Front protection | Switching system | Contacts | Switching action | Terminals | Ø 18 mm Typ-Nr. | Mounting dimensions | Technical drawing | Circuit drawing | |
|---|------------------|------------------|-------------|------------------|-----------|--------------------|---------------------|-------------------|-----------------|-------|
| Selector switch 3 positions Position C : Maintained action Position A : Basic position Position B : Maintained action | IP 40 | SA | 2 NC + 2 NO | MA-0-MA | S1 | 52-571.022A | 2 | 6 | 19 | 0.015 |
| | | | | M-0-MA | S1 | 52-574.022A | 2 | 6 | 17 | 0.015 |
| Position C : Momentary action Position A : Basic position Position B : Momentary action | IP 40 | SA | 2 NC + 2 NO | MA-0-M | S1 | 52-573.022A | 2 | 6 | 18 | 0.015 |
| | | | | M-0-M | S1 | 52-572.022A | 2 | 6 | 16 | 0.015 |

Switching system: SA = Snap-action switching element

Contacts: NC = Normally closed, NO = Normally open

Switching action: MA = Maintained action, M = Momentary action

Terminals: S1 = Soldering terminal (also pluggable 2.8 x 0.5 mm)



Mounting dimensions from page 41, Technical drawing from page 42, Circuit drawing from page 47

Indicator actuator, flush mounting

Actuators usable for front dimensions: \square 24 x 24 mm | \square 24 x 30 mm | 25 mm dia.



Essential Accessories:

-  Front bezel set for Indicators and Illuminated pushbutton, flush mounting page 25
-  Lens plastic, flush mounting page 21
-  Single-LED page 30

| | Front protection | Terminals | Typ-Nr. | Component layout | Mounting dimensions | Technical drawing | Circuit drawing |  |
|---|------------------|-----------|--------------------|------------------|---------------------|-------------------|-----------------|---|
| Indicator actuator, flush mounting | IP 65 | S | 51-050.005F | 3 | 15 | 1 | 0.004 | |
| | | S1 | 51-050.002F | 3 | 15 | 1 | 0.004 | |
| | | UT | 51-051.006F | 4 | 3 | 15 | 1 | 0.005 |

Terminals: S = Soldering terminal, S1 = Soldering terminal (also pluggable 2.8 x 0.5 mm), UT = Universal terminal



Component layout from page 40, Mounting dimensions from page 41, Technical drawing from page 42, Circuit drawing from page 47

Illuminated pushbutton actuator, flush mounting

Actuators usable for front dimensions: \square 24 x 24 mm | \square 24 x 30 mm | 25 mm dia.



Essential Accessories:

-  Front bezel set for Indicators and Illuminated pushbutton, flush mounting page 25
-  Lens plastic, flush mounting page 21
-  Single-LED page 30

| | Front protection | Switching system | Contacts | Switching action | Terminals | Typ-Nr. | Component layout | Mounting dimensions | Technical drawing | Circuit drawing |  | |
|--|------------------|------------------|-------------|------------------|---------------------|---------------------|---------------------|---------------------|-------------------|-----------------|---|-------|
| Illuminated pushbutton actuator, flush mounting | IP 65 | LL | 1 NC | MA | UT | 51-486.036F | 4 | 3 | 16 | 11 | 0.006 | |
| | | | | M | UT | 51-456.036F | 4 | 3 | 16 | 57 | 0.006 | |
| | | | 1 NC + 1 NO | MA | UT | 51-483.036F | 4 | 3 | 16 | 14 | 0.006 | |
| | | | | M | UT | 51-453.036F | 4 | 3 | 16 | 60 | 0.006 | |
| | | | 1 NO | MA | UT | 51-485.036F | 4 | 3 | 16 | 13 | 0.006 | |
| | | | | M | UT | 51-455.036F | 4 | 3 | 16 | 59 | 0.006 | |
| | | | 2 NC | MA | UT | 51-482.036F | 4 | 3 | 16 | 12 | 0.006 | |
| | | | | M | UT | 51-452.036F | 4 | 3 | 16 | 58 | 0.006 | |
| | | | 2 NO | MA | UT | 51-481.036F | 4 | 3 | 16 | 15 | 0.006 | |
| | | | | M | UT | 51-451.036F | 4 | 3 | 16 | 61 | 0.006 | |
| | | | SA | 1 NC + 1 NO | MA | S | 51-281.0252F | | 3 | 16 | 10 | 0.005 |
| | | | | | | S1 | 51-281.022F | | 3 | 16 | 7 | 0.007 |
| | | M | | | S | 51-151.0252F | | 3 | 16 | 56 | 0.005 | |
| | | | | | S1 | 51-151.022F | | 3 | 16 | 53 | 0.007 | |
| | | 2 NC + 2 NO | | MA | S | 51-282.0252F | | 3 | 16 | 6 | 0.008 | |
| | | | | | S | 51-152.0252F | | 3 | 16 | 52 | 0.008 | |
| | | 3 NC + 3 NO | | MA | S | 51-283.0252F | | 3 | 16 | 3 | 0.010 | |
| | | | | | S | 51-153.0252F | | 3 | 16 | 49 | 0.010 | |
| | | 4 NC + 4 NO | MA | S | 51-284.0252F | | 3 | 16 | 2 | 0.012 | | |
| | | | | S | 51-154.0252F | | 3 | 16 | 48 | 0.012 | | |

Switching system: LL = Low level switching element, SA = Snap-action switching element

Contacts: NC = Normally closed, NO = Normally open

Switching action: MA = Maintained action, M = Momentary action

Terminals: UT = Universal terminal, S = Soldering terminal, S1 = Soldering terminal (also pluggable 2.8 x 0.5 mm)

Component layout from page 40, Mounting dimensions from page 41, Technical drawing from page 42, Circuit drawing from page 47

Keylock switch actuator 2 positions, flush mounting



Essential Accessories:

Front bezel set for Keylock switch, flush mounting page 26

| | Front protection | Switching system | Contacts | Switching action | Terminals | Key remove | □ 24 x 24 mm Typ-Nr. | □ 24 x 30 mm Typ-Nr. | Ø 25 mm Typ-Nr. | Component layout | | | | kg | | | |
|---|------------------|------------------|-------------|------------------|-----------|---------------|-------------------------|-------------------------|--------------------|---------------------|-------------------|-----------------|----|-------|-------|-------|-------|
| | | | | | | | | | | Mounting dimensions | Technical drawing | Circuit drawing | | | | | |
| Keylock switch actuator 2 positions, flush mounting Position A : Basic position Position C : Maintained action Standard lock 311 Front : Plastic black | IP 65 | LL | 1 NC + 1 NO | MA | UT | A | 51-445.036DF | | | 4 | 3 | 17 | 76 | 0.027 | | | |
| | | | | | | C | 51-448.036DF | | | 4 | 3 | 17 | 76 | 0.027 | | | |
| | | | | | | C + A | 51-442.036DF | | | 4 | 3 | 17 | 76 | 0.027 | | | |
| | | | 2 NO | MA | UT | A | 51-444.036DF | | | 4 | 3 | 17 | 77 | 0.027 | | | |
| | | | | | | C | 51-447.036DF | | | 4 | 3 | 17 | 77 | 0.027 | | | |
| | | | | | | C + A | 51-441.036DF | | | 4 | 3 | 17 | 77 | 0.027 | | | |
| | | | SA | 1 NC + 1 NO | MA | S | A | 51-255.025D2F | | | | | 3 | 17 | 72 | 0.027 | |
| | | | | | | | C | 51-355.025D2F | | | | | 3 | 17 | 72 | 0.027 | |
| | | | | | | | C + A | 51-155.025D2F | | | | | 3 | 17 | 72 | 0.027 | |
| | | | | | | | S1 | A | 51-255.022DF | | | | | 3 | 17 | 72 | 0.027 |
| | | | | | | | C | 51-355.022DF | | | | | 3 | 17 | 72 | 0.027 | |
| | | | | | | | C + A | 51-155.022DF | | | | | 3 | 17 | 72 | 0.027 | |
| | | 2 NC + 2 NO | MA | S | A | 51-256.025D2F | | | | | 3 | 17 | 73 | 0.027 | | | |
| | | | | | C | 51-356.025D2F | | | | | 3 | 17 | 73 | 0.027 | | | |
| | | | | | C + A | 51-156.025D2F | | | | | 3 | 17 | 73 | 0.027 | | | |
| | | 3 NC + 3 NO | MA | S | A | 51-257.025D2F | | | | | 3 | 17 | 74 | 0.027 | | | |
| | | | | | C | 51-357.025D2F | | | | | 3 | 17 | 74 | 0.027 | | | |
| | | | | | C + A | 51-157.025D2F | | | | | 3 | 17 | 74 | 0.027 | | | |
| | | 4 NC + 4 NO | MA | S | A | 51-258.025D2F | | | | | 3 | 17 | 75 | 0.027 | | | |
| | | | | | C | 51-358.025D2F | | | | | 3 | 17 | 75 | 0.027 | | | |
| C + A | 51-158.025D2F | | | | | | | | 3 | 17 | 75 | 0.027 | | | | | |
| Position A : Basic position Position C : Momentary action Standard lock 311 Front : Plastic black | IP 65 | LL | 1 NC + 1 NO | M | UT | A | 51-458.036DF | | | 4 | 3 | 17 | 70 | 0.027 | | | |
| | | | | | | 2 NO | M | UT | A | 51-457.036DF | | | 4 | 3 | 17 | 71 | 0.027 |
| | | SA | 1 NC + 1 NO | M | S | A | 51-145.025D2F | | | | | 3 | 17 | 66 | 0.027 | | |
| | | | | | | S1 | A | 51-145.022DF | | | | | 3 | 17 | 66 | 0.027 | |
| | | | 2 NC + 2 NO | M | S | A | 51-146.025D2F | | | | | 3 | 17 | 67 | 0.027 | | |
| | | | | | | 3 NC + 3 NO | M | S | A | 51-147.025D2F | | | | | 3 | 17 | 68 |
| | | | 4 NC + 4 NO | M | S | A | 51-148.025D2F | | | | | 3 | 17 | 69 | 0.027 | | |

Continuation see next page

15
01.2010

eaom

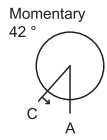
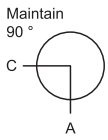

| | Front protection | Switching system | Contacts | Switching action | Terminals | Key remove | Ø 24 x 24 mm Typ-Nr. | Ø 24 x 30 mm Typ-Nr. | Ø 25 mm Typ-Nr. | Component layout | | Mounting dimensions | | Technical drawing | | Circuit drawing | |
|---|------------------|--|-------------|------------------|-------------|------------|-------------------------|-------------------------|----------------------|---------------------|----|---------------------|-------|-------------------|----|-----------------|--|
| | | | | | | | | | | | | | | | | | |
| Position A : Basic position Position C : Maintained action Standard lock 311 Front : Plastic black | IP 65 | LL | 1 NC + 1 NO | MA | UT | A | | 51-405.036DF | | 4 | 3 | 17 | 76 | 0.029 | | | |
| | | | | | | C | | 51-408.036DF | | 4 | 3 | 17 | 76 | 0.029 | | | |
| | | | | | | C + A | | 51-402.036DF | | 4 | 3 | 17 | 76 | 0.029 | | | |
| | | | 2 NO | MA | UT | A | | 51-404.036DF | | 4 | 3 | 17 | 77 | 0.029 | | | |
| | | | | | | C | | 51-407.036DF | | 4 | 3 | 17 | 77 | 0.029 | | | |
| | | | | | | C + A | | 51-401.036DF | | 4 | 3 | 17 | 77 | 0.029 | | | |
| | | | SA | 1 NC + 1 NO | MA | S | A | | 51-295.025D2F | | 3 | 17 | 72 | 0.029 | | | |
| | | | | | | | C | | 51-395.025D2F | | 3 | 17 | 72 | 0.029 | | | |
| | | | | | | | C + A | | 51-195.025D2F | | 3 | 17 | 72 | 0.029 | | | |
| | | | | | | S1 | A | | 51-295.022DF | | 3 | 17 | 72 | 0.029 | | | |
| | | | | | | | C | | 51-395.022DF | | 3 | 17 | 72 | 0.029 | | | |
| | | | | | | | C + A | | 51-195.022DF | | 3 | 17 | 72 | 0.029 | | | |
| | | 2 NC + 2 NO | | MA | S | A | | 51-296.025D2F | | 3 | 17 | 73 | 0.029 | | | | |
| | | | | | | C | | 51-396.025D2F | | 3 | 17 | 73 | 0.029 | | | | |
| | | | | | | C + A | | 51-196.025D2F | | 3 | 17 | 73 | 0.029 | | | | |
| | | 3 NC + 3 NO | | MA | S | A | | 51-297.025D2F | | 3 | 17 | 74 | 0.029 | | | | |
| | | | | | | C | | 51-397.025D2F | | 3 | 17 | 74 | 0.029 | | | | |
| | | | | | | C + A | | 51-197.025D2F | | 3 | 17 | 74 | 0.029 | | | | |
| | | 4 NC + 4 NO | MA | S | A | | 51-298.025D2F | | 3 | 17 | 75 | 0.029 | | | | | |
| | | | | | C | | 51-398.025D2F | | 3 | 17 | 75 | 0.029 | | | | | |
| | | | | | C + A | | 51-198.025D2F | | 3 | 17 | 75 | 0.029 | | | | | |
| | | Position A : Basic position Position C : Momentary action Standard lock 311 Front : Plastic black | IP 65 | LL | 1 NC + 1 NO | M | UT | A | | 51-428.036DF | | 4 | 3 | 17 | 70 | 0.029 | |
| | | | | | | | | A | | 51-427.036DF | | 4 | 3 | 17 | 71 | 0.029 | |
| | | | | | 2 NO | M | UT | A | | 51-427.036DF | | 4 | 3 | 17 | 71 | 0.029 | |
| A | | | | | | | | 51-495.025D2F | | 3 | 17 | 66 | 0.029 | | | | |
| SA | 1 NC + 1 NO | | | | M | S | A | | 51-495.025D2F | | 3 | 17 | 66 | 0.029 | | | |
| | | | | | | | A | | 51-495.022DF | | 3 | 17 | 66 | 0.029 | | | |
| 2 NC + 2 NO | M | | | S | A | A | | 51-496.025D2F | | 3 | 17 | 67 | 0.029 | | | | |
| | | | | | | A | | 51-497.025D2F | | 3 | 17 | 68 | 0.029 | | | | |
| 3 NC + 3 NO | M | | | S | A | A | | 51-497.025D2F | | 3 | 17 | 68 | 0.029 | | | | |
| | | | | | | A | | 51-498.025D2F | | 3 | 17 | 69 | 0.029 | | | | |
| 4 NC + 4 NO | M | | | S | A | A | | 51-498.025D2F | | 3 | 17 | 69 | 0.029 | | | | |
| | | | | | | A | | 51-498.025D2F | | 3 | 17 | 69 | 0.029 | | | | |
| Position A : Basic position Position C : Maintained action Standard lock 311 Front : Plastic black | IP 65 | LL | 1 NC + 1 NO | MA | UT | A | | 51-415.036DF | | 4 | 3 | 17 | 76 | 0.026 | | | |
| | | | | | | C | | 51-418.036DF | | 4 | 3 | 17 | 76 | 0.026 | | | |
| | | | | | | C + A | | 51-412.036DF | | 4 | 3 | 17 | 76 | 0.026 | | | |
| | | | 2 NO | MA | UT | A | | 51-414.036DF | | 4 | 3 | 17 | 77 | 0.026 | | | |
| | | | | | | C | | 51-417.036DF | | 4 | 3 | 17 | 77 | 0.026 | | | |
| | | | | | | C + A | | 51-411.036DF | | 4 | 3 | 17 | 77 | 0.026 | | | |
| | | | SA | 1 NC + 1 NO | MA | S | A | | 51-235.025D2F | | 3 | 17 | 72 | 0.026 | | | |
| | | | | | | | C | | 51-335.025D2F | | 3 | 17 | 72 | 0.026 | | | |
| | | | | | | | C + A | | 51-135.025D2F | | 3 | 17 | 72 | 0.026 | | | |
| | | | | | | S1 | A | | 51-235.022DF | | 3 | 17 | 72 | 0.026 | | | |
| | | | | | | | C | | 51-335.022DF | | 3 | 17 | 72 | 0.026 | | | |
| | | | | | | | C + A | | 51-135.022DF | | 3 | 17 | 72 | 0.026 | | | |
| | | 2 NC + 2 NO | MA | S | A | A | | 51-236.025D2F | | 3 | 17 | 73 | 0.026 | | | | |
| | | | | | | C | | 51-336.025D2F | | 3 | 17 | 73 | 0.026 | | | | |
| | | | | | | C + A | | 51-136.025D2F | | 3 | 17 | 73 | 0.026 | | | | |
| | | 3 NC + 3 NO | MA | S | A | A | | 51-237.025D2F | | 3 | 17 | 74 | 0.026 | | | | |
| | | | | | | C | | 51-337.025D2F | | 3 | 17 | 74 | 0.026 | | | | |
| | | | | | | C + A | | 51-137.025D2F | | 3 | 17 | 74 | 0.026 | | | | |
| | | 4 NC + 4 NO | MA | S | A | A | | 51-238.025D2F | | 3 | 17 | 75 | 0.026 | | | | |
| | | | | | | C | | 51-338.025D2F | | 3 | 17 | 75 | 0.026 | | | | |
| | | | | | | C + A | | 51-138.025D2F | | 3 | 17 | 75 | 0.026 | | | | |

Continuation see next page

Continued from previous page

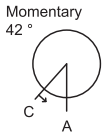
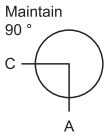

| | Front protection | Switching system | Contacts | Switching action | Terminals | Key remove | □ 24 x 24 mm Typ-Nr. | □ 24 x 30 mm Typ-Nr. | ∅ 25 mm Typ-Nr. | Component layout | Mounting dimensions | Technical drawing | Circuit drawing | |
|--|------------------|------------------|-------------|------------------|-----------|------------|-------------------------|-------------------------|----------------------|------------------|---------------------|-------------------|-----------------|-------|
| Position A : Basic position Position C : Momentary action Standard lock 311 Front : Plastic black | IP 65 | LL | 1 NC + 1 NO | M | UT | A | | | 51-438.036DF | 4 | 3 | 17 | 70 | 0.026 |
| | | | 2 NO | M | UT | A | | | 51-437.036DF | 4 | 3 | 17 | 71 | 0.026 |
| | | SA | 1 NC + 1 NO | M | S | A | | | 51-141.025D2F | 3 | 17 | 66 | 66 | 0.026 |
| | | | | | S1 | A | | | 51-141.022DF | 3 | 17 | 66 | 66 | 0.026 |
| | | | 2 NC + 2 NO | M | S | A | | | 51-142.025D2F | 3 | 17 | 67 | 67 | 0.026 |
| | | | 3 NC + 3 NO | M | S | A | | | 51-143.025D2F | 3 | 17 | 68 | 68 | 0.026 |
| | | | 4 NC + 4 NO | M | S | A | | | 51-144.025D2F | 3 | 17 | 69 | 69 | 0.026 |
| | | | | | | | | | | | | | | |

Other lock numbers on request

Switching system: LL = Low level switching element, SA = Snap-action switching element

Contacts: NC = Normally closed, NO = Normally open

Switching action: MA = Maintained action, M = Momentary action

Terminals: UT = Universal terminal, S = Soldering terminal, S1 = Soldering terminal (also pluggable 2.8 x 0.5 mm)

Component layout from page 40, Mounting dimensions from page 41, Technical drawing from page 42, Circuit drawing from page 47

Keylock switch actuator 3 positions, flush mounting



Essential Accessories:

 Front bezel set for Keylock switch, flush mounting page 26

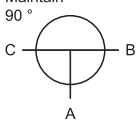
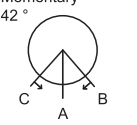
| Maintain 90°  | Momentary 42°  | Front protection | Switching system | Contacts | Switching action | Terminals | Key remove | \varnothing 24 x 24 mm Typ-Nr. | \square 24 x 30 mm Typ-Nr. | \varnothing 25 mm Typ-Nr. | Mounting dimensions | | | | |
|--|---|------------------|------------------|----------|------------------|-----------|------------|-------------------------------------|---------------------------------|--------------------------------|---------------------|-----------------|----|-------|-------|
| | | | | | | | | | | | Technical drawing | Circuit drawing | 3 | 4 | 65 |
| Keylock switch actuator 3 positions, flush mounting Position C : Maintained action Position A : Basic position Position B : Maintained action Standard lock 311 | | | | | | | | | | | | | | | |
| Position C : Maintained action Position A : Basic position Position B : Maintained action Standard lock 311 | IP 65 | SA | 2 NC + 2 NO | MA-0-MA | S1 | A | A | 51-381.022DF | 51-361.022DF | 51-371.022DF | 3 | 4 | 65 | 0.027 | |
| | | | | | | | | C + B | 51-383.022DF | 51-363.022DF | 51-373.022DF | 3 | 4 | 65 | 0.027 |
| | | | | | | | | C+A+B | 51-382.022DF | 51-362.022DF | 51-372.022DF | 3 | 4 | 65 | 0.027 |
| Position C : Maintained action Position A : Basic position Position B : Momentary action Standard lock 311 | IP 65 | SA | 2 NC + 2 NO | MA-0-M | S1 | A | A | 51-385.022DF | 51-365.022DF | 51-375.022DF | 3 | 4 | 64 | 0.027 | |
| | | | | | | | | C + A | 51-386.022DF | 51-366.022DF | 51-376.022DF | 3 | 4 | 64 | 0.027 |
| Position C : Momentary action Position A : Basic position Position B : Maintained action Standard lock 311 | IP 65 | SA | 2 NC + 2 NO | M-0-MA | S1 | A | A | 51-387.022DF | 51-367.022DF | 51-377.022DF | 3 | 4 | 62 | 0.027 | |
| | | | | | | | | A + B | 51-388.022DF | 51-368.022DF | 51-378.022DF | 3 | 4 | 62 | 0.027 |
| Position C : Momentary action Position A : Basic position Position B : Momentary action Standard lock 311 | IP 65 | SA | 2 NC + 2 NO | M-0-M | S1 | A | A | 51-384.022DF | 51-364.022DF | 51-374.022DF | 3 | 4 | 63 | 0.027 | |

Other lock numbers on request

Switching system: SA = Snap-action switching element

Contacts: NC = Normally closed, NO = Normally open

Switching action: MA = Maintained action, M = Momentary action

Terminals: S1 = Soldering terminal (also pluggable 2.8 x 0.5 mm)

Mounting dimensions from page 41, Technical drawing from page 42, Circuit drawing from page 47



Selector switch actuator 2 positions, flush mounting

illuminative

Actuators usable for front dimensions: \square 24 x 24 mm | 25 mm dia.



Essential Accessories:

-  Front bezel set for Selector switch, flush mounting page 26
-  Lever, flush mounting page 24
-  Single-LED page 30

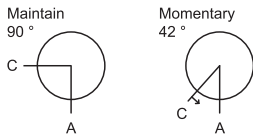

| | Front protection | Switching system | Contacts | Switching action | Terminals | Typ-Nr. | Component layout | Mounting dimensions | Technical drawing | Circuit drawing | |
|--|------------------|------------------|-------------|------------------|-------------------|--------------------|------------------|---------------------|-------------------|-----------------|-------|
| Selector switch actuator 2 positions, flush mounting Position A : Basic position Position C : Maintained action | IP 65 | LL | 1 NC | MA | UT | 52-476.036 | 4 | 3 | 18 | 43 | 0.007 |
| | | | 1 NC + 1 NO | MA | UT | 52-473.036 | 4 | 3 | 18 | 46 | 0.007 |
| | | | 1 NO | MA | UT | 52-475.036 | 4 | 3 | 18 | 45 | 0.007 |
| | | | 2 NC | MA | UT | 52-472.036 | 4 | 3 | 18 | 44 | 0.007 |
| | | | 2 NO | MA | UT | 52-471.036 | 4 | 3 | 18 | 47 | 0.007 |
| | | SA | 1 NC + 1 NO | MA | S | 52-271.0252 | | 3 | 18 | 42 | 0.006 |
| | | | | S1 | 52-271.022 | | 3 | 18 | 39 | 0.006 | |
| | | | 2 NC + 2 NO | MA | S | 52-272.0252 | | 3 | 18 | 38 | 0.006 |
| | | | 3 NC + 3 NO | MA | S | 52-273.0252 | | 3 | 18 | 35 | 0.006 |
| | | | 4 NC + 4 NO | MA | S | 52-274.0252 | | 3 | 18 | 34 | 0.006 |
| Position A : Basic position Position C : Momentary action | IP 65 | LL | 1 NC | M | UT | 52-436.036 | 4 | 3 | 18 | 29 | 0.007 |
| | | | 1 NC + 1 NO | M | UT | 52-433.036 | 4 | 3 | 18 | 32 | 0.007 |
| | | | 1 NO | M | UT | 52-435.036 | 4 | 3 | 18 | 31 | 0.007 |
| | | | 2 NC | M | UT | 52-432.036 | 4 | 3 | 18 | 30 | 0.007 |
| | | | 2 NO | M | UT | 52-431.036 | 4 | 3 | 18 | 33 | 0.007 |
| | | SA | 1 NC + 1 NO | M | S | 52-131.0252 | | 3 | 18 | 28 | 0.006 |
| | | | | S1 | 52-131.022 | | 3 | 18 | 25 | 0.006 | |
| | | | 2 NC + 2 NO | M | S | 52-132.0252 | | 3 | 18 | 24 | 0.006 |
| | | | 3 NC + 3 NO | M | S | 52-133.0252 | | 3 | 18 | 21 | 0.006 |
| | | | 4 NC + 4 NO | M | S | 52-134.0252 | | 3 | 18 | 20 | 0.006 |

Switching system: LL = Low level switching element, SA = Snap-action switching element

Contacts: NC = Normally closed, NO = Normally open

Switching action: MA = Maintained action, M = Momentary action

Terminals: UT = Universal terminal, S = Soldering terminal, S1 = Soldering terminal (also pluggable 2.8 x 0.5 mm)

Component layout from page 40, Mounting dimensions from page 41, Technical drawing from page 42, Circuit drawing from page 47



Selector switch actuator 3 positions, flush mounting

illuminative

Actuators usable for front dimensions: \square 24 x 24 mm | 25 mm dia.



Essential Accessories:

-  Front bezel set for Selector switch, flush mounting page 26
-  Lever, raised mounting page 24
-  Single-LED page 30

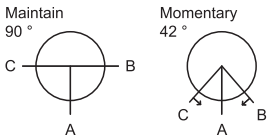

| | Front protection | Switching system | Contacts | Switching action | Terminals | Typ-Nr. | Mounting dimensions | Technical drawing | Circuit drawing |  |
|--|------------------|------------------|-------------|------------------|-----------|--------------------|---------------------|-------------------|-----------------|---|
| Selector switch actuator 3 positions, flush mounting Position C : Maintained action Position A : Basic position Position B : Maintained action | IP 40 | SA | 2 NC + 2 NO | MA-0-MA | S1 | 52-571.022A | 3 5 19 | | | 0.015 |
| | | | | M-0-MA | S1 | 52-574.022A | 3 5 17 | | 0.015 | |
| Position C : Momentary action Position A : Basic position Position B : Momentary action | IP 40 | SA | 2 NC + 2 NO | MA-0-M | S1 | 52-573.022A | 3 5 18 | | | 0.015 |
| | | | | M-0-M | S1 | 52-572.022A | 3 5 16 | | 0.015 | |

Switching system: SA = Snap-action switching element

Contacts: NC = Normally closed, NO = Normally open

Switching action: MA = Maintained action, M = Momentary action

Terminals: S1 = Soldering terminal (also pluggable 2.8 x 0.5 mm)

Mounting dimensions from page 41, Technical drawing from page 42, Circuit drawing from page 47

Front

Lens plastic, raised mounting

| | Lens | ∅ 18 x 18 mm Typ-Nr. | ∅ 18 x 24 mm Typ-Nr. | ∅ 18 mm Typ-Nr. |  |
|---|------------------------|-------------------------|-------------------------|--------------------|---|
| Lens plastic, raised mounting concave, illuminative | blue transparent | 51-954.6 | 51-904.6 | | 0.001 |
| | colourless transparent | 51-954.7 | 51-904.7 | | 0.001 |
| | green transparent | 51-954.5 | 51-904.5 | | 0.001 |
| | orange transparent | 51-954.3 | 51-904.3 | | 0.001 |
| | red transparent | 51-954.2 | 51-904.2 | | 0.001 |
| | yellow transparent | 51-954.4 | 51-904.4 | | 0.001 |
| flush, illuminative | blue transparent | 51-953.6 | 51-903.6 | 51-933.6 | 0.001 |
| | colourless transparent | 51-953.7 | 51-903.7 | 51-933.7 | 0.001 |
| | green transparent | 51-953.5 | 51-903.5 | 51-933.5 | 0.001 |
| | orange transparent | 51-953.3 | 51-903.3 | 51-933.3 | 0.001 |
| | red transparent | 51-953.2 | 51-903.2 | 51-933.2 | 0.001 |
| | smoked transparent | 51-953.1 | 51-903.1 | 51-933.1 | 0.001 |
| | yellow transparent | 51-953.4 | 51-903.4 | 51-933.4 | 0.001 |
| flush, illuminative (not recommended for film insert) | blue translucent | 51-951.6 | 51-901.6 | 51-931.6 | 0.001 |
| | colourless transparent | 51-955.7 | 51-905.7 | 51-935.7 | 0.001 |
| | green translucent | 51-951.5 | 51-901.5 | 51-931.5 | 0.001 |
| | green transparent | 51-955.5 | 51-905.5 | 51-935.5 | 0.001 |
| | orange translucent | 51-951.3 | 51-901.3 | 51-931.3 | 0.001 |
| | red translucent | 51-951.2 | 51-901.2 | 51-931.2 | 0.001 |
| | red transparent | 51-955.2 | 51-905.2 | 51-935.2 | 0.001 |
| | white translucent | 51-951.9 | 51-901.9 | 51-931.9 | 0.001 |
| | yellow translucent | 51-951.4 | 51-901.4 | 51-931.4 | 0.001 |
| | yellow transparent | 51-955.4 | 51-905.4 | 51-935.4 | 0.001 |
| flush, non-illuminative | black opaque | 51-951.0 | 51-901.0 | 51-931.0 | 0.001 |
| | grey opaque | 51-951.8 | 51-901.8 | 51-931.8 | 0.001 |
| concave, illuminative (not recommended for film insert) | colourless transparent | | 51-906.7 | | 0.001 |
| | green transparent | | 51-906.5 | | 0.001 |
| | red transparent | | 51-906.2 | | 0.001 |
| | yellow transparent | | 51-906.4 | | 0.001 |



Lens plastic, flush mounting

mat

| | Lens | ∅ 24 x 24 mm Typ-Nr. | ∅ 24 x 30 mm Typ-Nr. | ∅ 25 mm Typ-Nr. |  |
|---|------------------------------|-------------------------|-------------------------|--------------------|---|
| Lens plastic, flush mounting illuminative | blue transparent flush | 61-9671.6 | 61-9681.6 | 61-9642.6 | 0.002 |
| | colourless transparent flush | 61-9671.7 | 61-9681.7 | 61-9642.7 | 0.002 |
| | green transparent flush | 61-9671.5 | 61-9681.5 | 61-9642.5 | 0.002 |
| | orange transparent flush | 61-9671.3 | 61-9681.3 | 61-9642.3 | 0.002 |
| | red transparent flush | 61-9671.2 | 61-9681.2 | 61-9642.2 | 0.002 |
| | smoked transparent flush | 61-9671.1 | 61-9681.1 | 61-9642.1 | 0.002 |
| | yellow transparent flush | 61-9671.4 | 61-9681.4 | 61-9642.4 | 0.002 |
| non-illuminative | black opaque flush | 61-9771.0 | 61-9781.0 | | 0.002 |
| | grey opaque flush | 61-9771.8 | 61-9781.8 | | 0.002 |
| | white translucent flush | 61-9771.9 | 61-9781.9 | | 0.002 |



Lens plastic with symbol, flush mounting

| | Symbol | Lens | Ø 25 mm Typ-Nr. |  |
|--|----------|------------------------|--------------------|---|
| Lens plastic with symbol, flush mounting flush - level, illuminative | ON/OFF | blue transparent | 61-9643.602 | 0.002 |
| | | colourless transparent | 61-9643.702 | 0.002 |
| | | green transparent | 61-9643.502 | 0.002 |
| | | red transparent | 61-9643.202 | 0.002 |
| | Ring | blue transparent | 61-9643.601 | 0.002 |
| | | colourless transparent | 61-9643.701 | 0.002 |
| | | green transparent | 61-9643.501 | 0.002 |
| | | orange transparent | 61-9643.301 | 0.002 |
| | | red transparent | 61-9643.201 | 0.002 |
| | | yellow transparent | 61-9643.401 | 0.002 |
| | Stand by | blue transparent | 61-9643.603 | 0.002 |
| | | colourless transparent | 61-9643.703 | 0.002 |
| | | green transparent | 61-9643.503 | 0.002 |
| red transparent | | 61-9643.203 | 0.002 | |



The silvery coat is being applied on the lens (screen print) with an additional protective lacquer.

Marking plate for lens round plastic, flush mounting

can be hot stamped

| | Marking plate | Typ-Nr. |  |
|--|--------------------------------|------------------|---|
| Marking plate for lens round plastic, flush mounting only applicable with Lens round Typ-Nr. 61-9642.X | Plastic colourless transparent | 61-9707.7 | 0.001 |



Lens metal with spot, flush mounting

mat

| | Lens | Ø 25 mm Typ-Nr. |  |
|---|-----------------------------|--------------------|---|
| Lens metal with spot, flush mounting | Aluminium black flush | 61-9841.0A | 0.002 |
| | Aluminium blue flush | 61-9841.6A | 0.002 |
| | Aluminium gold flush | 61-9841.4A | 0.002 |
| | Aluminium natural flush | 61-9841.8A | 0.002 |
| | Aluminium olive-green flush | 61-9841.5A | 0.002 |
| | Aluminium red flush | 61-9841.2A | 0.002 |



Lens metal, flush mounting

mat

| | Lens | Ø 25 mm Typ-Nr. |  |
|---|-----------------------|--------------------|---|
| Lens metal, flush mounting convex | Aluminium black | 61-9842.0 | 0.003 |
| | Aluminium blue | 61-9842.6 | 0.003 |
| | Aluminium gold | 61-9842.4 | 0.003 |
| | Aluminium natural | 61-9842.8 | 0.003 |
| | Aluminium olive-green | 61-9842.5 | 0.003 |
| | Aluminium red | 61-9842.2 | 0.003 |
| flush | Aluminium black | 61-9841.0 | 0.002 |
| | Aluminium blue | 61-9841.6 | 0.002 |
| | Aluminium gold | 61-9841.4 | 0.002 |
| | Aluminium natural | 61-9841.8 | 0.002 |
| | Aluminium olive-green | 61-9841.5 | 0.002 |
| | Aluminium red | 61-9841.2 | 0.002 |



Mushroom-head cap, flush mounting

| | Mushroom had cap | Ø 32 mm Typ-Nr. |  |
|--|-----------------------|--------------------|---|
| Mushroom-head cap, flush mounting | Plastic black opaque | 61-9593.0 | 0.004 |
| | Plastic green opaque | 61-9593.5 | 0.004 |
| | Plastic red opaque | 61-9593.2 | 0.004 |
| | Plastic yellow opaque | 61-9593.4 | 0.004 |



Front bezel square for selector switch, raised mounting

| | Front bezel | Typ-Nr. |  |
|--|---------------|-----------------|---|
| Front bezel square for selector switch, raised mounting 24 x 24 mm | Plastic black | 52-950.0 | 0.001 |
| 26 x 26 mm | Plastic black | 52-952.0 | 0.001 |



Lever, raised mounting

with bar and marking dot

| | Lever | Bar colour | Typ-Nr. |  kg |
|---|---------------|------------|------------------|--|
| Lever, raised mounting illuminative | Plastic black | blue | 52-928.60 | 0.001 |
| | | green | 52-928.50 | 0.001 |
| | | orange | 52-928.30 | 0.001 |
| | | red | 52-928.20 | 0.001 |
| | | yellow | 52-928.40 | 0.001 |
| | Plastic grey | blue | 52-929.60 | 0.001 |
| | | green | 52-929.50 | 0.001 |
| | | orange | 52-929.30 | 0.001 |
| | | red | 52-929.20 | 0.001 |
| | | yellow | 52-929.40 | 0.001 |
| non-illuminative | Plastic black | black | 52-928.0 | 0.001 |
| | Plastic grey | grey | 52-929.8 | 0.001 |
| | | white | 52-929.9 | 0.001 |



Lever, flush mounting

with bar and marking dot

| | Lever | Bar colour | Typ-Nr. |  kg |
|--|---------------|------------|-------------------|--|
| Lever, flush mounting illuminative | Plastic black | blue | 61-9028.60 | 0.001 |
| | | green | 61-9028.50 | 0.001 |
| | | orange | 61-9028.30 | 0.001 |
| | | red | 61-9028.20 | 0.001 |
| | | yellow | 61-9028.40 | 0.001 |
| | Plastic grey | blue | 61-9029.60 | 0.001 |
| | | green | 61-9029.50 | 0.001 |
| | | orange | 61-9029.30 | 0.001 |
| | | red | 61-9029.20 | 0.001 |
| | | yellow | 61-9029.40 | 0.001 |
| non-illuminative | Plastic black | black | 61-9028.0 | 0.001 |
| | | white | 61-9028.9 | 0.001 |
| | Plastic grey | grey | 61-9029.8 | 0.001 |
| | | white | 61-9029.9 | 0.001 |



Legend frame

for devices 25 mm dia., flush mounting

| | Typ-Nr. | Technical drawing |  kg |
|--|------------------|-------------------|--|
| Legend frame 30 x 50 mm, adhesive, Aluminium black | 61-9980.0 | 10 | 0.001 |



Technical drawing from page 42

Legend plate insert

for Legend frame 61-9980.0

| | Typ-Nr. |  |
|---|------------------|---|
| Legend plate insert 14.5 x 23.5 mm, adhesive, Aluminium black | 704.968.1 | 0.001 |
| 14.5 x 23.5 mm, adhesive, Aluminium natural | 704.968.0 | 0.001 |



Front bezel set for Indicators and Illuminated pushbutton, flush mounting

| | Front bezel | ∅ 24 x 24 mm Typ-Nr. | ∅ 24 x 30 mm Typ-Nr. | ∅ 25 mm Typ-Nr. | Mounting dimensions |  |
|--|-----------------------|-------------------------|-------------------------|--------------------|---------------------|---|
| Front bezel set for Indicators and Illuminated pushbutton, flush mounting | Plastic black | 61-9930.0 | 61-9931.0 | 61-9933.10 | 3 | 0.008 |
| | Plastic silver | 61-9930.4 | 61-9931.4 | | 3 | 0.008 |
| | Aluminium black | | | 61-9933.1 | 3 | 0.006 |
| | Aluminium blue | | | 61-9933.6 | 3 | 0.006 |
| | Aluminium gold | | | 61-9933.4 | 3 | 0.006 |
| | Aluminium natural | | | 61-9933.0 | 3 | 0.006 |
| | Aluminium olive-green | | | 61-9933.5 | 3 | 0.006 |
| | Aluminium red | | | 61-9933.2 | 3 | 0.006 |



Mounting dimensions from page 41

Front bezel set for Mushroom-head pushbutton, flush mounting

| | Front bezel | ∅ 40 mm Typ-Nr. | ∅ 25 mm Typ-Nr. | Mounting dimensions |  |
|---|-----------------------|--------------------|--------------------|---------------------|---|
| Front bezel set for Mushroom-head pushbutton, flush mounting | Aluminium natural | 61-9934.8 | | 4 | 0.013 |
| | Aluminium black | | 61-9933.1 | 4 | 0.006 |
| | Aluminium blue | | 61-9933.6 | 4 | 0.006 |
| | Aluminium gold | | 61-9933.4 | 4 | 0.006 |
| | Aluminium natural | | 61-9933.0 | 4 | 0.006 |
| | Aluminium olive-green | | 61-9933.5 | 4 | 0.006 |
| | Aluminium red | | 61-9933.2 | 4 | 0.006 |
| | Plastic black | | 61-9933.10 | 4 | 0.008 |



Mounting dimensions from page 41

Front bezel set for Keylock switch, flush mounting

| | Front bezel | ∅ 24 x 24 mm Typ-Nr. | ∅ 24 x 30 mm Typ-Nr. | ∅ 25 mm Typ-Nr. | Mounting dimensions |  |
|---|-----------------------|-------------------------|-------------------------|--------------------|---------------------|---|
| Front bezel set for Keylock switch, flush mounting | Plastic black | 61-9930.0 | 61-9931.0 | 61-9932.10 | 3 | 0.008 |
| | Plastic silver | 61-9930.4 | 61-9931.4 | | 3 | 0.008 |
| | Aluminium black | | | 61-9932.1 | 3 | 0.006 |
| | Aluminium blue | | | 61-9932.6 | 3 | 0.006 |
| | Aluminium gold | | | 61-9932.4 | 3 | 0.006 |
| | Aluminium natural | | | 61-9932.0 | 3 | 0.006 |
| | Aluminium olive-green | | | 61-9932.5 | 3 | 0.006 |
| | Aluminium red | | | 61-9932.2 | 3 | 0.006 |



With the round front bezel sets ∅25 mm the anti-twist ring is part of the sales-package.
Mounting dimensions from page 41

Front bezel set for Selector switch, flush mounting

| | Front bezel | ∅ 24 x 24 mm Typ-Nr. | ∅ 25 mm Typ-Nr. | Mounting dimensions |  |
|--|-----------------------|-------------------------|--------------------|---------------------|---|
| Front bezel set for Selector switch, flush mounting | Plastic black | 61-9936.0 | | 3 | 0.007 |
| | Aluminium black | | 61-9932.1 | 3 | 0.006 |
| | Aluminium blue | | 61-9932.6 | 3 | 0.006 |
| | Aluminium gold | | 61-9932.4 | 3 | 0.006 |
| | Aluminium natural | | 61-9932.0 | 3 | 0.006 |
| | Aluminium olive-green | | 61-9932.5 | 3 | 0.006 |
| | Aluminium red | | 61-9932.2 | 3 | 0.006 |
| | Plastic black | | 61-9932.10 | 3 | 0.008 |



With the round front bezel sets ∅25 mm the anti-twist ring is part of the sales-package.
Mounting dimensions from page 41

Front protective cap

for flush - level lenses only for protection IP 68

| | Front protective cap | Typ-Nr. |  |
|---|------------------------------|------------------|---|
| Front protective cap for front bezel set 24 x 30 mm, flush mounting | Silicone natural transparent | 61-9927.2 | 0.001 |
| for front bezel set 25 mm dia., flush mounting | Silicone natural transparent | 84-9103.7 | 0.001 |



ATTENTION

when using the front protection cover for push buttons the external sealing in the front bezel set and the silicone bellows in the actuator are to be removed !

Protective cover, raised mounting

| | Ø 18 x 18 mm Typ-Nr. | Ø 18 x 24 mm Typ-Nr. | Technical drawing | |
|---|-------------------------|-------------------------|-------------------|-------|
| Protective cover, raised mounting hinged, transparent, with means for sealing | 51-920 | | 2 | 0.002 |
| | | 51-925 | 3 | 0.002 |



Technical drawing from page 42

Protective cover, flush mounting

| | Ø 24 x 24 mm Typ-Nr. | Ø 24 x 30 mm Typ-Nr. | Ø 25 mm Typ-Nr. | Mounting dimensions | Technical drawing | |
|--|-------------------------|-------------------------|--------------------|---------------------|-------------------|-------|
| Protective cover, flush mounting hinged, transparent, with means for sealing | 61-9921.0 | | | 3 | 7 | 0.006 |
| | | 61-9922.0 | | 3 | 8 | 0.006 |
| slide by side, with means not for sealing | | | 61-9924.0 | 3 | 9 | 0.006 |



Mounting dimensions from page 41, Technical drawing from page 42

Blind plug, raised mounting

| | Blind plug | Ø 18 x 18 mm Typ-Nr. | Ø 18 x 24 mm Typ-Nr. | Ø 18 mm Typ-Nr. | Mounting dimensions | |
|------------------------------------|---------------|-------------------------|-------------------------|--------------------|---------------------|-------|
| Blind plug, raised mounting | Plastic black | 51-948.0 | 51-947.0 | 51-949.0 | 1 | 0.003 |

Blind plugs fit also in mounting holes no. 2
Mounting dimensions from page 41



Blind plug, flush mounting

| | Blind plug | Ø 24 x 24 mm Typ-Nr. | Ø 24 x 30 mm Typ-Nr. | Ø 25 mm Typ-Nr. | Mounting dimensions | Technical drawing | |
|-----------------------------------|---------------|-------------------------|-------------------------|--------------------|---------------------|-------------------|-------|
| Blind plug, flush mounting | Plastic black | 61-9451.0 | 61-9452.0 | | 3 | | 0.006 |
| | | | | 61-9453.0 | 3 | 11 | 0.006 |

Mounting dimensions from page 41, Technical drawing from page 42



Master key

| | Typ-Nr. |  |
|---|-------------------|---|
| Master key Lock numbers 311 ... 445 (DOM) | 31-989.300 | 0.006 |



Spare key

| | Typ-Nr. |  |
|--|-------------------|---|
| Spare key Key lock switch, standard lock 311 (DOM) | 31-989.311 | 0.006 |



Other lock numbers on request

EMC Key protection cap

| | Typ-Nr. |  |
|---|-----------------|---|
| EMC Key protection cap Plastic black, for lock type DOM | 31-985.0 | 0.005 |



Backside

PCB plug-in base

| | Terminals | Typ-Nr. | Component layout |  |
|--|-----------|---------------|------------------|---|
| PCB plug-in base 16.4 mm dia. x 9.8 mm for Low level switching element, Pins axial | P | 31-940 | 2 | 0.002 |
| 17.8 x 12.9 mm x 9.8 mm for Snap-action switching element 2.8 mm, Pins axial | P | 31-942 | 3 | 0.002 |
| 17.9 x 17.9 x 8.4 mm for Low level switching element, Pins bent at right-angle | P | 31-941 | 1 | 0.004 |



PCB plug-in base Pins right-angle : With the extendable mounting the distance between plug-in base and PCB can be varied up to 3 mm.

Terminals: P = PCB terminal

Component layout from page 40

Multi-plug housing

| | Typ-Nr. |  |
|--|-----------------|---|
| Multi-plug housing for Switching block | 51-943.0 | 0.005 |



Flat receptacle

| | Typ-Nr. |  |
|---|-----------------|---|
| Flat receptacle 2.0 x 0.5 mm for Universal terminal | 31-945 | 0.001 |
| 2.8 x 0.5 mm for Multi-plug housing | 51-943.1 | 0.001 |
| 2.8 x 0.5 mm for Plug-in terminal | 31-946 | 0.001 |



Insulation sleeve

| | Typ-Nr. |  |
|--|---------------|---|
| Insulation sleeve Cover Plug-in terminals for snap-action switching element 2.8 mm | 01-928 | 0.001 |
| for Flat receptacle 31-945 | 31-928 | 0.001 |
| for Flat receptacle 31-946 | 31-929 | 0.001 |



Terminal cover

| | Typ-Nr. |  |
|-----------------------|---------------|---|
| Terminal cover | 01-929 | 0.010 |



Illumination

Filament lamp

| | Socket | Operating voltage/-current | Typ-Nr. |  |
|----------------------|-----------|----------------------------|---------------------|---|
| Filament lamp | T1 3/4 MG | 12 VAC/DC, 75 mA | 10-1309.1309 | 0.001 |
| | | 14 VAC/DC, 80 mA | 10-1310.1319 | 0.001 |
| | | 18 VAC/DC, 40 mA | 10-1311.1249 | 0.001 |
| | | 24 VAC/DC, 35 mA | 10-1312.1229 | 0.001 |
| | | 28 VAC/DC, 30 mA | 10-1313.1209 | 0.001 |
| | | 28 VAC/DC, 40 mA | 10-1313.1249 | 0.001 |
| | | 36 VAC/DC, 20 mA | 10-1316.1179 | 0.001 |
| | | 36 VAC/DC, 30 mA | 10-1316.1209 | 0.001 |
| | | 48 VAC/DC, 20 mA | 10-1319.1179 | 0.001 |
| | | 48 VAC/DC, 25 mA | 10-1319.1199 | 0.001 |
| | | 6 VAC/DC, 120 mA | 10-1306.1349 | 0.001 |
| | | 6.3 VAC/DC, 200 mA | 10-1307.1369 | 0.001 |



Single-LED

| Single-LED | Socket | Light colour | Operating voltage/-current | Typ-Nr. |  |
|--------------|--------------|---------------|----------------------------|--------------|---|
| Single-LED | T1 3/4 MG | blue | 12 VAC/DC, 7/14 mA | 10-2J09.1066 | 0.002 |
| | | | 24 VAC/DC, 7/14 mA | 10-2J12.1066 | 0.002 |
| | | | 28 VAC/DC, 7/14 mA | 10-2J13.1066 | 0.002 |
| | | | 48 VAC/DC, 4/8 mA | 10-2J19.1046 | 0.002 |
| | | | 6 VDC, 15 mA | 10-2J06.3146 | 0.002 |
| | | green | 12 VAC/DC, 4/7 mA | 10-2J09.1065 | 0.002 |
| | | | 24 VAC/DC, 4/7 mA | 10-2J12.1065 | 0.002 |
| | | | 28 VAC/DC, 4/7 mA | 10-2J13.1065 | 0.002 |
| | | | 48 VAC/DC, 2/4 mA | 10-2J19.1045 | 0.002 |
| | | | 6 VDC, 7 mA | 10-2J06.3145 | 0.002 |
| | | red | 12 VAC/DC, 7/14 mA | 10-2J09.1062 | 0.002 |
| | | | 24 VAC/DC, 7/14 mA | 10-2J12.1062 | 0.002 |
| | | | 28 VAC/DC, 7/14 mA | 10-2J13.1062 | 0.002 |
| | | | 48 VAC/DC, 4/8 mA | 10-2J19.1042 | 0.002 |
| | | | 6 VDC, 15 mA | 10-2J06.3142 | 0.002 |
| | | white diffuse | 12 VAC/DC, 7/14 mA | 10-2J09.1069 | 0.002 |
| | | | 24 VAC/DC, 7/14 mA | 10-2J12.1069 | 0.002 |
| | | | 28 VAC/DC, 7/14 mA | 10-2J13.1069 | 0.002 |
| | | | 48 VAC/DC, 4/8 mA | 10-2J19.1049 | 0.002 |
| | | | 6 VDC, 15 mA | 10-2J06.3149 | 0.002 |
| | | yellow | 12 VAC/DC, 7/14 mA | 10-2J09.1064 | 0.002 |
| | | | 24 VAC/DC, 7/14 mA | 10-2J12.1064 | 0.002 |
| | | | 28 VAC/DC, 7/14 mA | 10-2J13.1064 | 0.002 |
| | | | 48 VAC/DC, 4/8 mA | 10-2J19.1044 | 0.002 |
| 6 VDC, 15 mA | 10-2J06.3144 | | 0.002 | | |



Note:
AC operation through halve-wave rectifier possible, slight flickering can occur.

Series resistor

for lamp voltage reduction

| Series resistor | Operating voltage | Typ-Nr. |  |
|---|-------------------|----------|---|
| 10 kΩ, for filament lamp 48 VAC, 25 mA | 230/240 V | 02-904.7 | 0.003 |
| 2.7 kΩ, for filament lamp 48 VAC, 25 mA | 110 V | 02-904.0 | 0.003 |
| 3.3 kΩ, for filament lamp 48 VAC, 25 mA | 125 V | 02-904.1 | 0.003 |
| 4.7 kΩ, for filament lamp 48 VAC, 25 mA | 145 V | 02-904.3 | 0.003 |



Please keep to the country specific security rules.

Terminal plate empty

for fitting with series resistors

| Terminal plate empty | Typ-Nr. |  |
|------------------------------|----------|---|
| 10 spaces 125 x 60 x 15 mm | 02-912.2 | 0.045 |
| 15 spaces 187.5 x 60 x 15 mm | 02-912.3 | 0.090 |
| 20 spaces 250 x 60 x 15 mm | 02-912.4 | 0.095 |
| 5 spaces 62.5 x 60 x 15 mm | 02-912.1 | 0.025 |



Assembling

Fixing nut

| | Typ-Nr. |  |
|---|---------------|---|
| Fixing nut Metal, specifically for keylock switches | 31-991 | 0.005 |



Anti-twist ring

for Key lock- and Selector switch

| | Typ-Nr. |  |
|------------------------|---------------|---|
| Anti-twist ring | 51-910 | 0.001 |



Lens remover

| | Typ-Nr. |  |
|---|------------------|---|
| Lens remover for flush mounting | 61-9730.0 | 0.011 |
| for raised mounting | 02-905 | 0.011 |



Lamp remover

| | Typ-Nr. |  |
|---------------------|------------------|---|
| Lamp remover | 61-9740.0 | 0.003 |



CAUTION

A switching process might be released when replacing the lamp/LED !

Mounting tool

| | Typ-Nr. |  |
|----------------------|---------------|---|
| Mounting tool | 01-907 | 0.020 |



Dismantling tool

| | Typ-Nr. |  |
|---|---------------|---|
| Dismantling tool for dismantling of Lens, Lens holder and Switching element block | 51-938 | 0.027 |



Flat receptacle remover

| | Typ-Nr. |  kg |
|---|-----------------|--|
| Flat receptacle remover for removing the Flat receptacle of the Multi-plug in housing | 51-943.9 | 0.001 |



Actuator with snap-action switching element

Switching system

Self-cleaning, double-break, snap action switching system (with contact gap 2 x 0.5 mm).
 1 normally closed or 1 normally open contact per element.
 Snap-action switching elements with soldering terminals at the sides: up to 4 switching element can be on a pushbutton (max. 4 normally closed and 4 normally open contacts).
 Snap-action switching element with axial plug-in terminals 2.8 mm stachable, only 1 switching element can be on a pushbutton.

Material

Material of contact
 Gold plated silver

Switch housing
 Axial soldering-/plug-in terminal 2.8 mm:
 Diallylphthalate DAP, Polyamide 66, Polysulfone, heat-resistant and self-extinguishing.
 Soldering terminal: PA 6.6 Ultramid

Actuator housing
 Polyetherimide, self-extinguishing

Mechanical characteristics

Terminals
 Snap-action switching element with tinned soldering terminals at the sides:
 Max. wire diameter 2 wires à 1.2 mm
 Max. wire cross-section of stranded cable 1 x 1 mm²

Snap-action switching element with axial soldering terminals, which can also be used as plug-in terminals 2.8 x 0.5 mm:
 Max. wire diameter 2 wires of 1 mm
 Max. wire cross-section of stranded cable 2 of 0.75 mm² or 1 x 1.0 mm²

Actuating torque
 2.5 Ncm ... 5.5 Ncm, depending on the number of switching elements. Measured at the key or lever of the keylock- or selector switch.

Actuating force
 4 N ... 6 N, depending on the number of switching elements

Actuating travel
 Illuminated pushbutton 3 mm

Keylock-/selector switch actuator 2 positions:
 1x ca. 42° deflection momentary action
 1x ca. 90° deflection maintained action

Rebound time
 ≤5ms

Mechanical lifetime

| | |
|-------------------|-------------------------------|
| Momentary action | 2 million cycles of operation |
| Maintained action | 1 million cycles of operation |
| Keylock switch | 50 000 cycles of operation |

Electrical characteristics

Standards
 IEC 61058, EN 61058

Rated voltage
 250 VAC/VDC

Rated current
 5 A

Contact resistance
 Starting value (initial) ≤50 mΩ

Electrostatic discharge (ESD)
 ≤15 KV (Keylock switch)

Conventional free air thermal current
 5 A
 The maximum current in continuous operation and at ambient temperature not exceeding the quoted maximum values.

Switch rating
 250 VAC, 5 A (cosφ 1)
 250 VAC, 3 A (cosφ 0,3)

Switch rating AC (cosφ 0,7)

| | | |
|---------|---------|---------|
| Voltage | 125 VAC | 250 VAC |
| Current | 3 A | 2 A |

Switch rating DC (inductive) L:R = 30 ms

| | | | | |
|---------|--------|--------|---------|---------|
| Voltage | 24 VDC | 60 VDC | 110 VDC | 220 VDC |
| Current | 2 A | 0.7 A | 0.2 A | 0.1 A |

Electric strength
 2500 VAC, 50 Hz, 1 min. between all terminals and earth, as per IEC 60512-2-11

Protection class
 II

Environmental conditions

Storage temperature
 -40 °C ... +85 °C

Service temperature
 -25 °C ... +55 °C
 For indicators and illuminated pushbuttons mounted as a block, make sure the heat can escape freely.

Protection degree
 IP 65 front side, as per IEC 60529

Shock resistance
 (Single impacts, semi-sinusoidal)
 15 g for 11 ms, as per IEC 60512-4-3, IEC 60068-2-27

Vibration resistance
 (Sinusoidal)
 10 g at 10 Hz ... 1500 Hz, amplitude 1.5 mm, as per IEC 60512-4-4, IEC 60068-2-6

Climate resistance
 Standard condition, as per IEC 60068-2-3 and 2-30
 Changing condition, as per IEC 60068-2-14 and 2-33

Approvals

Approbations
 CB (IEC 61058)
 CSA
 ENEC (EN 61058)
 Germanischer Lloyd
 UL

Declaration of conformity
CE

Actuator with snap-action switching element block (Keylock- and Selector switch 3 positions)

Switching system

Self-cleaning, double-break, snap action switching system
1 normally closed or 1 normally open contact per element.

Material

Material of contact
Gold plated hardsilver

Switch housing
Diallylphthalate (DAP), heat-resistant and self-extinguishing

Actuator housing
Polyetherimide, self-extinguishing

Mechanical characteristics

Terminals
Soldering terminal which can also be used as plug-in terminal
2.8 x 0.5 mm:
Max. wire diameter 2 wires of 1 mm
Max. wire cross-section of stranded cable 2 x 0.75 mm²

Actuating torque
2.5 Ncm ... 5.5 Ncm, depending on the number of switching elements. Measured at the key or lever of the keylock- or selector switch.

Actuating travel
Keylock-/selector switch actuator with 3 positions
2x ca. 42° deflection momentary action
2x ca. 90° deflection maintained action

Rebound time
≤5ms

Mechanical lifetime
Keylock switch 50 000 cycles of operation
Selector switch 100 000 cycles of operation

Electrical characteristics

Electrostatic discharge (ESD)
≤15 KV (Keylock switch)

Conventional free air thermal current
5 A
The maximum current in continuous operation and at ambient temperature not exceeding the quoted maximum values.

Switch rating
250 VAC, 5 A (cosφ 0,75)

Electric strength
2500 VAC, 50 Hz, 1 min. between all terminals and earth, as per IEC 60512-2-11

Protection class
II

Environmental conditions

Storage temperature
-40 °C ... +85 °C

Service temperature
-25 °C ... +55 °C
for selector switches mounted as a block, make sure the heat can escape freely

Protection degree
Front side, as per IEC 60529
IP 65 keylock switch
IP 40 selector switch

Approvals

Approbations
CB (IEC 61058)
CSA
ENEC (EN 61058)
Germanischer Lloyd
UL

Declaration of conformity
CE

Actuator with low level switching element

Switching system

This low level switching element was designed for switching low powers in electronic circuits. The mechanism assures reliable switching of loads ranging from a few μA / μV up to 100 mA / 42 VAC/ DC.

Single-break momentary contact, as normally open or normally closed with 4 independent points of contact. 2 momentary contacts per switching element; combination of normally open and normally closed is possible.

Special features are the long life, extremely short rebound time and stable contact resistance.

Material

Material of contact
Gold plated

Switch housing
Polysulfone, heat-resistant and self-extinguishing

Actuator housing
Polyetherimide, self-extinguishing

Mechanical characteristics

Terminals
The universal terminals permit these units to be mounted on printed circuit boards (PCB). These terminals can also be used as soldering or plug-in terminals.

For these terminals we can also supply a plug-in base which, when soldered on to the board, enables the switch to be plugged in.

Soldering terminal:
Max. wire diameter 2 wires à 0.8 mm
Max. wire cross-section of stranded cable 1x 0.75 mm²

Plug-in terminal 2.0 x 0.5 mm

Actuating torque
2.5 Ncm ... 5.5 Ncm, measured at the key or lever of the keylock- or selector switch

Actuating force

3 N ... 3,5 N

Actuating travel

Illuminated pushbutton 3 mm

Keylock-/selector switch actuator 2 positions:

1x ca. 42° deflection momentary action

1x ca. 90° deflection maintained action

Rebound time

Typ. <100 µs

Mechanical lifetime

Momentary action 5 million cycles of operation

Maintained action 1 million cycles of operation

Keylock switch 50 000 cycles of operation

Electrical characteristics**Contact resistance**

Starting value (initial) ≤50 mΩ

Electrostatic breakdown value

≤15 KV (Keylock switch)

Switch rating

10 µA, 100 µV to 100 mA at 42 VAC/VDC

Electric strength

2500 VAC, 50 Hz, 1 min. between all terminals and earth, as per IEC 60512-2-11

Environmental conditions**Storage temperature**

-40 °C ... +85 °C

Service temperature

-25 °C ... +55 °C

For indicators and illuminated pushbuttons mounted as a block, make sure the heat can escape freely.

Protection degree

IP 65 front side, as per IEC 60529

Shock resistance

(Single impacts, semi-sinusoidal)

15 g for 11 ms, as per IEC 60512-4-3, IEC 60068-2-27

Diode element

When indicators and illuminated pushbuttons equipped with diodes, the user is able to perform a lamp check or wire an alarm circuit simply with a considerable saving of space.

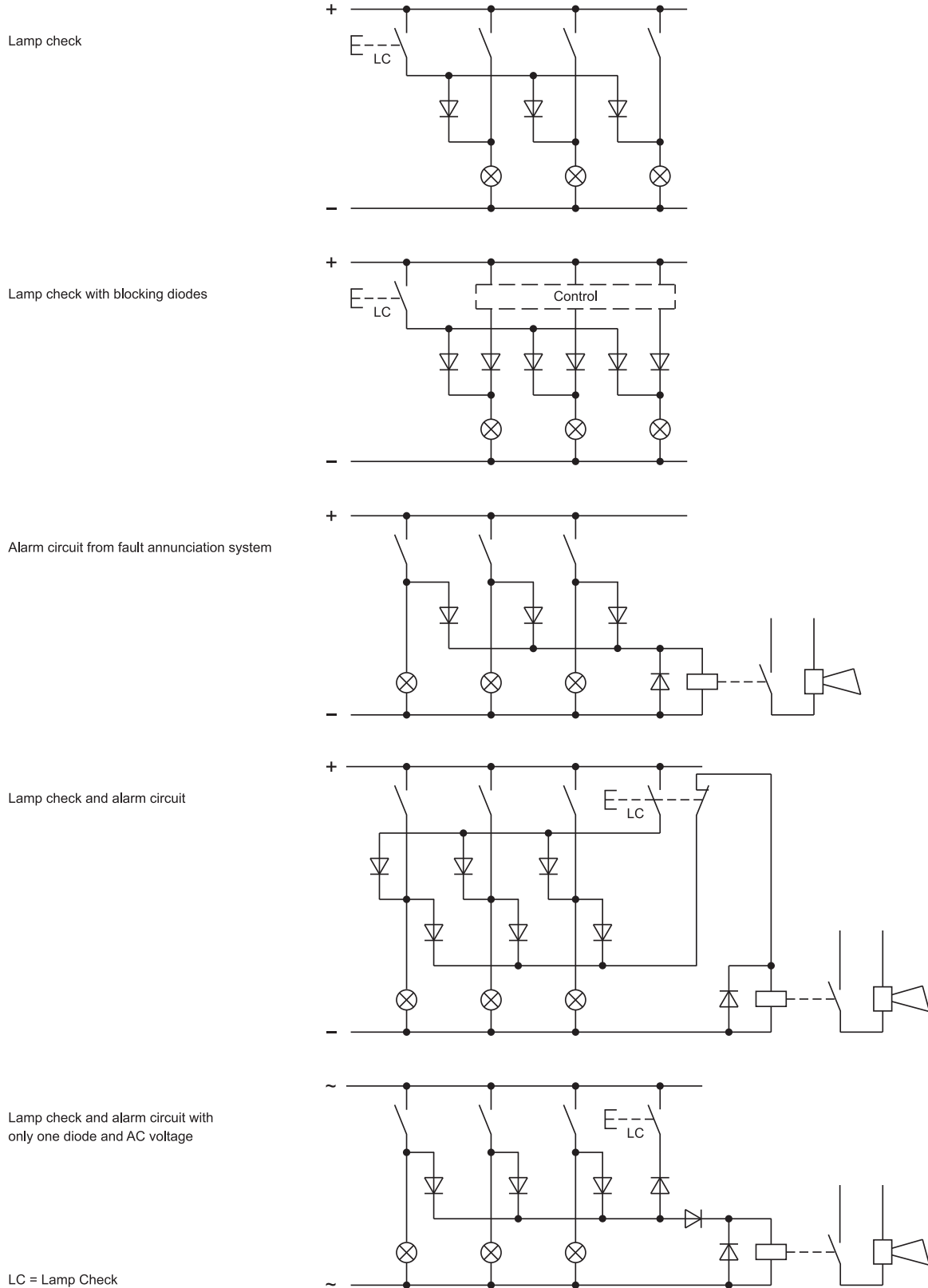

Suppressor circuits

When switching inductive loads such as relays, DC motors, and DC solenoids, it is always important to absorb surges (e.g. with a diode) to protect the contacts. When these inductive loads are switched off, a counter emf can severely damage switch contacts and greatly shorten lifetime.

Fig. 1 shows an inductive load with a free-wheeling diode connected in parallel. This free-wheeling diode provides a path for the inductor current to flow when the current is interrupted by the switch. Without this free-wheeling diode, the voltage across the coil will be limited only by dielectric breakdown voltages of the circuit or parasitic elements of the coil. This voltage can be kilovolts in amplitude even when nominal circuit voltages are low (e.g. 12 VDC) see Fig. 2.

The free-wheeling diode should be chosen so that the reverse breakdown voltage is greater than the voltage driving the inductive load. The DC blocking voltage (V_R) of the free-wheeling diode can be found in the datasheet of a diode. The forward current should be equal or greater than the maximum current flowing through the load.

To get an efficient protection, the free-wheeling diode must be connected as close as possible to the inductive load!

Switching with inductive load
Fig. 1

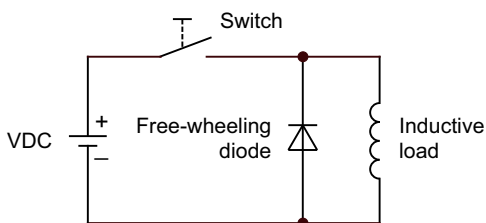

Counter emf
over load without free-wheeling diode
Fig. 2

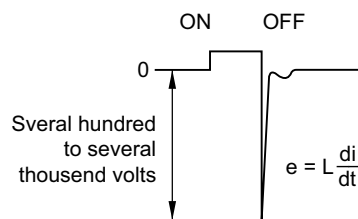

General notes

1. Engraving

In addition to the most commonly used world languages, in DIN 1451-3 close spacing, other typefaces are available as Scandinavian, Slavic, Greek, Russian and Polish.

Red, blue and black lenses are filled with white colour. Other colour lenses are filled in black. Standard height of letters is 2 mm. If the height is not specified, we will supply 2 mm engraved letters.

2. Hot stamping

For larger series it is worth considering markings by means of hot stamping. We will be pleased to advise you. For letters and figures, typefaces with 2.5 mm, 3 mm and 4 mm are available.

3. Film inserts

Instead of using engraving the lenses can be fitted with transparent film inserts, as an alternative. For this purpose, though, it is advisable to use transparent lenses.

In the case of use of a smoke-black lens the fitted film becomes readable only if the lamp is on.

The film thickness is 0.2 mm.

Important : Consider pushbutton mounting orientation before specifying engraving characters !

Lenses for indicators and illuminated pushbuttons, raised mounting

All dimensions in mm

| Front size (Lens) | Film insert max. size | Height of letters h | Number of lines | Number of (target value) capital letters per line | Number of (target value) small letters per line | Image |
|--------------------------|-----------------------|---------------------|-----------------|---|---|-------|
| 18 dia. (15.8 dia.) | 12.8 dia. | 2 | 3 | 6 | 6 | B4 |
| | | 3 | 2 | 5 | 6 | B4 |
| | | 4 | 2 | 3 | 4 | B4 |
| | | 5 | 1 | 2 | 3 | B4 |
| | | 6 | 1 | 2 | 3 | B4 |
| | | 8 | 1 | 2 | 2 | B4 |
| 18 x 18 (15.3 x 15.3) | 12.7 x 12.7 | 2 | 4 | 7 - 8 | 8 | B3 |
| | | 3 | 3 | 6 - 7 | 7 | B3 |
| | | 4 | 2 | 4 - 5 | 5 | B3 |
| | | 5 | 2 | 3 - 4 | 4 | B3 |
| | | 6 | 1 | 3 | 3 - 4 | B3 |
| | | 8 | 1 | 2 - 3 | 2 - 3 | B3 |
| 18 x 24 (15.3 x 21.5) | 12.7 x 18.7 | 2 | 4 | 11 | 12 | B1 |
| | | | 5 | 7 - 8 | 8 | B2 |
| | | 3 | 3 | 9 - 10 | 10 - 11 | B1 |
| | | | 4 | 6 - 7 | 7 | B2 |
| | | 4 | 2 | 7 | 7 - 8 | B1 |
| | | | 3 | 4 - 5 | 5 | B2 |
| | | 5 | 2 | 5 - 6 | 6 | B1 |
| | | | | 3 - 4 | 4 | B2 |
| | | 6 | 1 | 4 - 5 | 5 | B1 |
| | | | 2 | 3 | 3 - 4 | B2 |
| | | 8 | 1 | 3 - 4 | 3 - 4 | B1 |
| | | | | 2 - 3 | 2 - 3 | B2 |

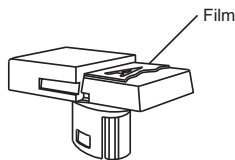
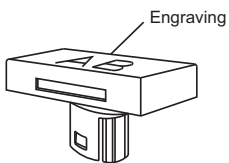

B1

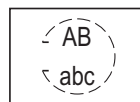

B2

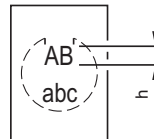

B3

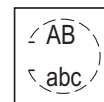

B4



Lenses for indicators and illuminated pushbuttons, flush mounting

All dimensions in mm

| Front size (Lens) | Film insert max. size | Height of letters h | Number of lines | Number of (target value) capital letters per line | Number of (target value) small letters per line | Image |
|------------------------|-----------------------|---------------------|-----------------|---|---|-------|
| 24 x 24 (18 x 18) | 15.1 x 15.1 | 2 | 4 | 8 - 9 | 9 | B3 |
| | | 3 | 3 | 7 - 8 | 8 | B3 |
| | | 4 | 2 | 4 - 5 | 5 | B3 |
| | | 5 | 2 | 4 | 4 - 5 | B3 |
| | | 6 | 1 | 4 | 4 | B3 |
| | | 8 | 1 | 2 - 3 | 2 - 3 | B3 |
| 24 x 30 (18 x 24) | 15.1 x 21 | 2 | 4 | 12 | 13 | B1 |
| | | | 5 | 8 - 9 | 9 | B2 |
| | | 3 | 3 | 10 - 11 | 11 - 12 | B1 |
| | | | 4 | 7 - 8 | 8 | B2 |
| | | 4 | 2 | 7 | 8 | B1 |
| | | | 3 | 4 - 5 | 5 | B2 |
| | | 5 | 2 | 5 - 6 | 6 | B1 |
| | | | | 4 | 4 - 5 | B2 |
| | | 6 | 1 | 4 - 5 | 5 | B1 |
| | | | 2 | 3 | 3 - 4 | B2 |
| | | 8 | 1 | 3 - 4 | 3 - 4 | B1 |
| | | | | 2 - 3 | 2 - 3 | B2 |
| 25 dia. (19.7 dia.) | Marking plate | 2 | 3 | 6 | 6 | B4 |
| | | 3 | 2 | 5 | 6 | B4 |
| | | 4 | 2 | 3 | 4 | B4 |
| | | 5 | 1 | 2 | 3 | B4 |
| | | 6 | 1 | 2 | 3 | B4 |
| | | 8 | 1 | 2 | 2 | B4 |

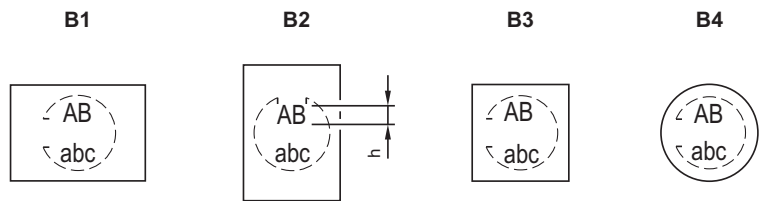
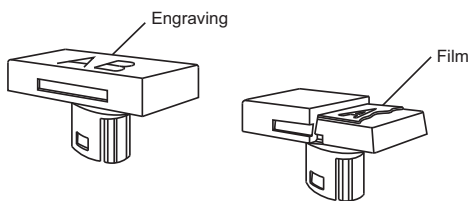

Component layout

1 PCB plug-in base page 28

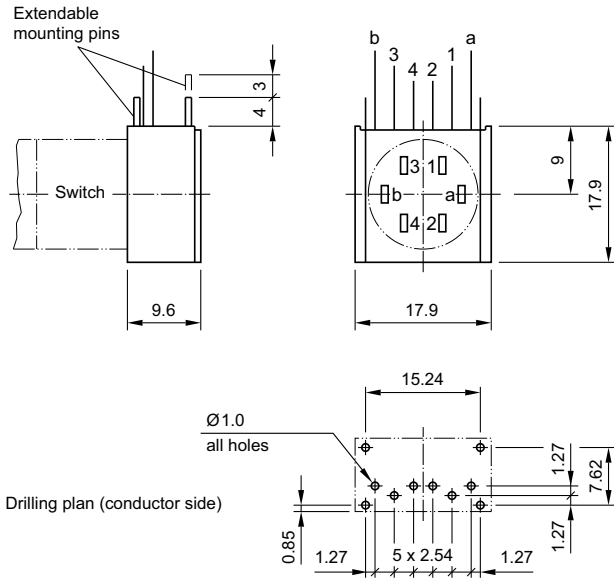

2 PCB plug-in base page 28

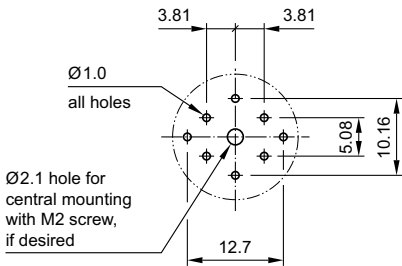

3 PCB plug-in base page 28

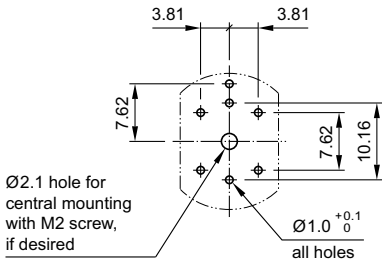

4 Indicator actuator page 7 | Illuminated pushbutton actuator page 8 | Keylock switch 2 positions page 9 | Selector switch 2 positions page 11 | Indicator actuator, flush mounting page 13 | Illuminated pushbutton actuator, flush mounting page 14 | Keylock switch actuator 2 positions, flush mounting page 15 | Selector switch actuator 2 positions, flush mounting page 19

Terminal (rearside)

PCB layout (conductor side)

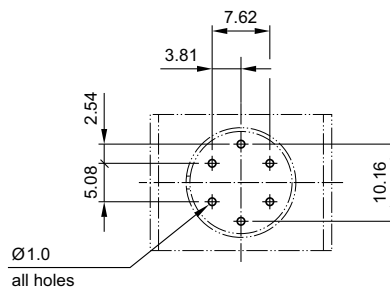
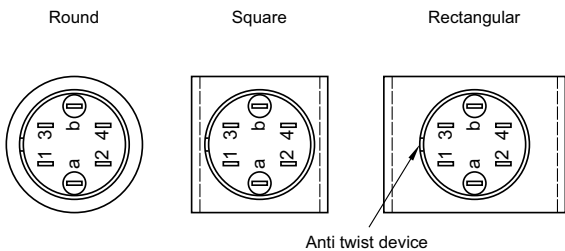

Mounting dimensions

1 Indicator actuator page 7 | Illuminated pushbutton actuator page 8 | Blind plug, raised mounting page 27

18 x 18 mm

18 x 24 mm

Ø18 mm

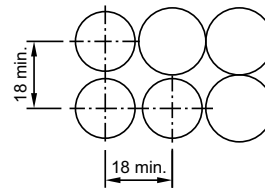
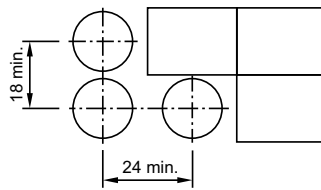
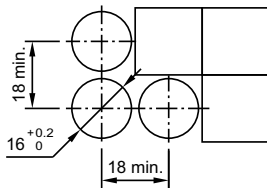

2 Keylock switch 2 positions page 9 | Keylock switch 3 positions page 10 | Selector switch 2 positions page 11 | Selector switch 3 positions page 12

18 x 18 mm

18 x 24 mm

Ø18 mm

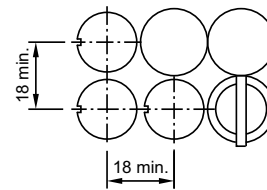
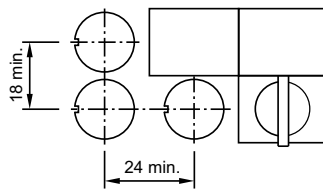
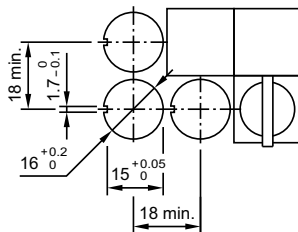

3 Indicator actuator, flush mounting page 13 | Illuminated pushbutton actuator, flush mounting page 14 | Keylock switch actuator 2 positions, flush mounting page 15 | Keylock switch actuator 3 positions, flush mounting page 18 | Selector switch actuator 2 positions, flush mounting page 19 | Selector switch actuator 3 positions, flush mounting page 20 | Front bezel set for Indicators and Illuminated pushbutton, flush mounting page 25 | Front bezel set for Keylock switch, flush mounting page 26 | Front bezel set for Selector switch, flush mounting page 26 | Protective cover, flush mounting page 27 | Blind plug, flush mounting page 27

Ø25 mm

24 x 30 mm

24 x 24 mm

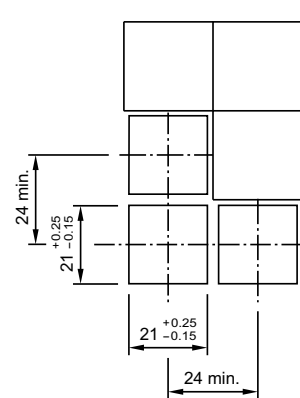
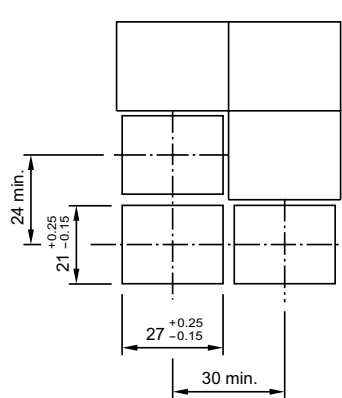
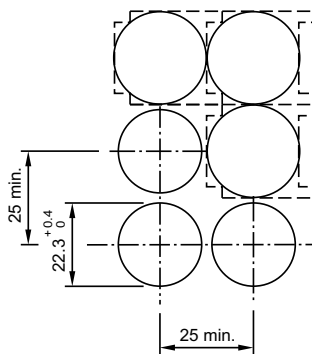

- Hole spacing min. 26 mm / min. 26 mm by using of the round front protective cap 84-9103.7
- Hole spacing min. 31 mm / min. 25 mm by using of the rectangular front protectice cap 61-9927.2

4 Front bezel set for Mushroom-head pushbutton, flush mounting page 25

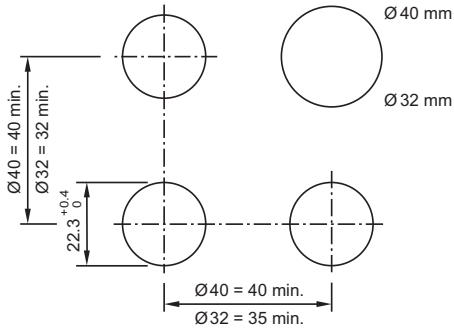

Technical drawing

1 Keylock switch 3 positions page 10

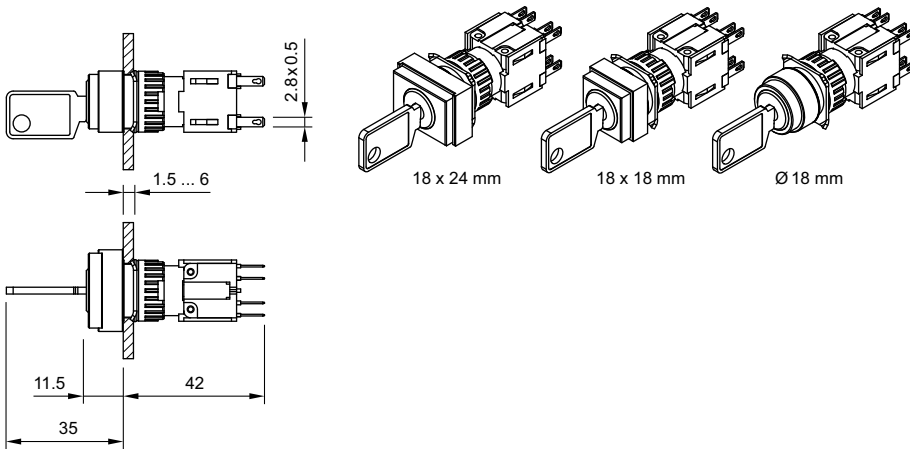

2 Protective cover, raised mounting page 27

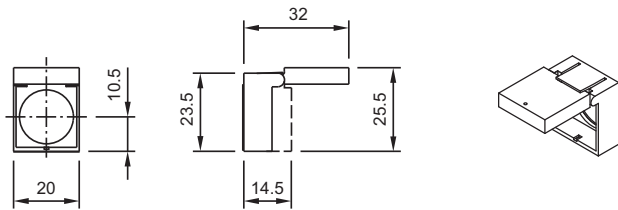

3 Protective cover, raised mounting page 27

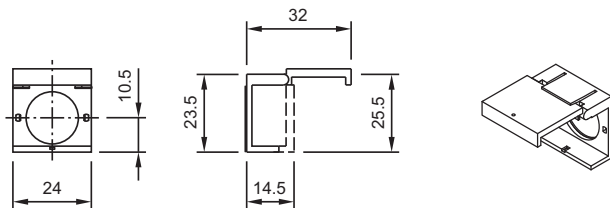

4 Keylock switch actuator 3 positions, flush mounting page 18

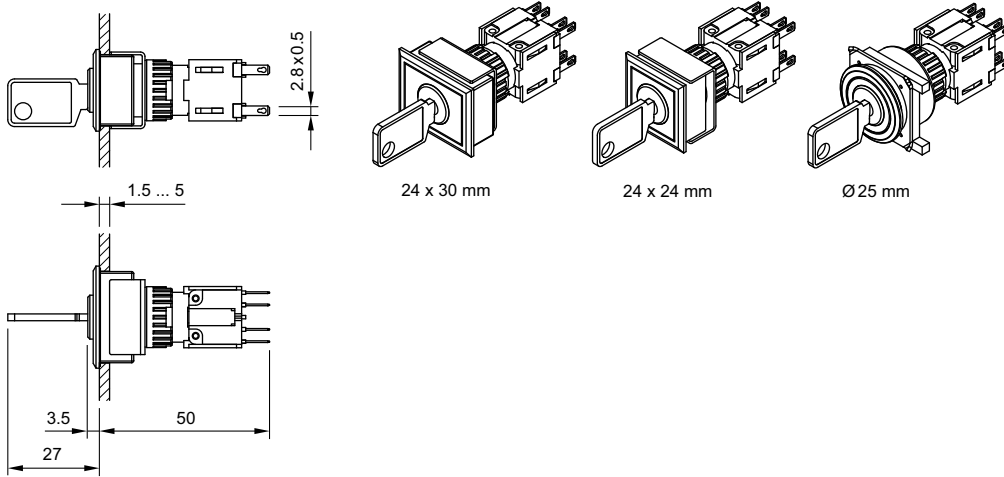

5 Selector switch actuator 3 positions, flush mounting page 20

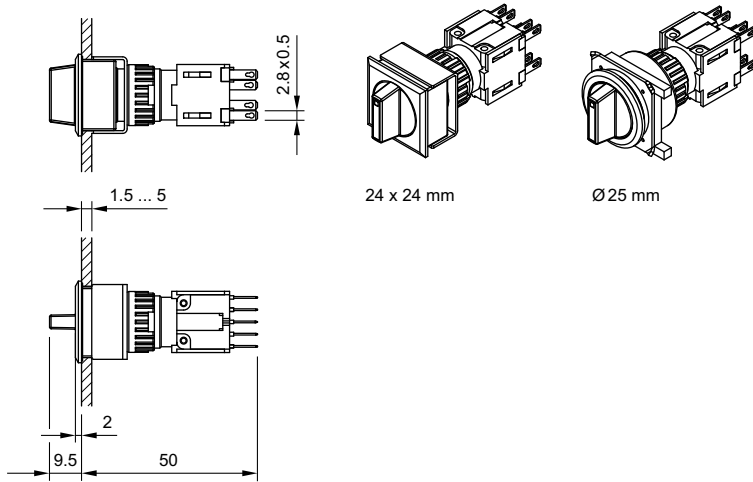

6 Selector switch 3 positions page 12

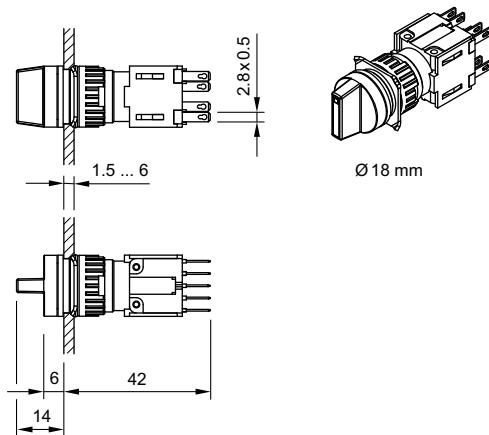

7 Protective cover, flush mounting page 27

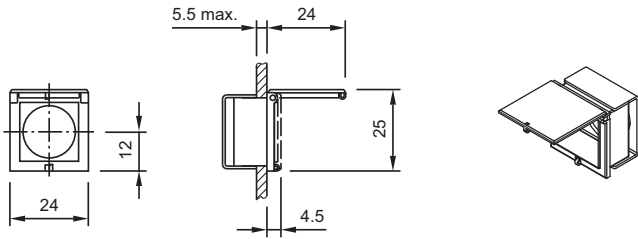

8 Protective cover, flush mounting page 27

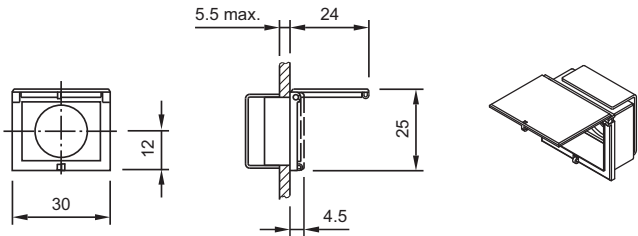

9 Protective cover, flush mounting page 27

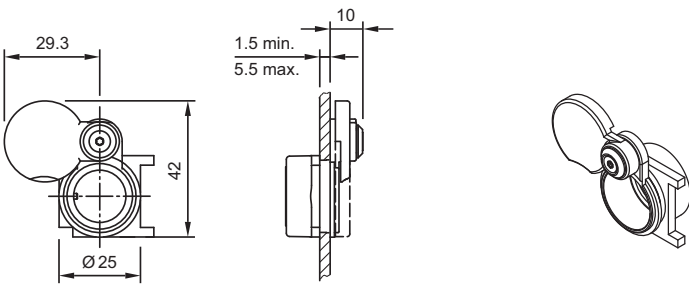

10 Legend frame page 24

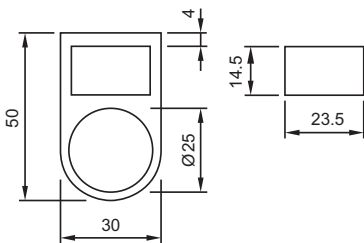

11 Blind plug, flush mounting page 27

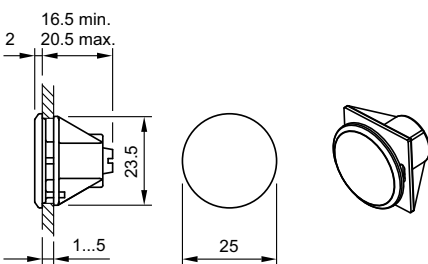

12 Indicator actuator page 7

| Soldering terminal | Soldering terminal (also pluggable) | Universal terminal | Universal terminal + diodes |
|--------------------|-------------------------------------|--------------------|-----------------------------|
| L | L1 | U | U+D |
| 23 | 26 | 35 | - |
| 1D, 2D | | | 35 |

13 Illuminated pushbutton actuator page 8

| | Soldering terminal | Soldering terminal (also pluggable) | Universal terminal | Combined terminal + diodes |
|-----------------------------|--------------------|-------------------------------------|--------------------|----------------------------|
| | L | L1 | U | H+D |
| 1NC+1NO | 28 | 36 | - | - |
| 2NC+2NO | 35.5 | - | - | - |
| 3NC+3NO | 43 | - | - | - |
| 4NC+4NO | 50.5 | - | - | - |
| 1NC+1NO+D | - | - | - | 43.5 |
| 2NO+2NC+D | - | - | - | 51 |
| 1NC, 1NO, 1NC+1NO, 2NC, 2NO | 35 | | | - |

14 Keylock switch 2 positions page 9

| | Soldering terminal | Soldering terminal (also pluggable) | Universal terminal |
|-----------------------------|--------------------|-------------------------------------|--------------------|
| | L | L1 | U |
| 1NC+1NO | 26.5 | 36 | - |
| 2NC+2NO | 34 | - | - |
| 3NC+3NO | 41.5 | - | - |
| 4NC+4NO | 49 | - | - |
| 1NC, 1NO, 1NC+1NO, 2NC, 2NO | 35.5 | | |

15 Indicator actuator, flush mounting page 13

| Soldering terminal | | Soldering terminal (also pluggable) | | Universal terminal | |
|--------------------|----|-------------------------------------|--|--------------------|--|
| L | L1 | U | | | |
| 31 | 34 | 44 | | | |

16 Illuminated pushbutton actuator, flush mounting page 14

| | Soldering terminal | | Soldering terminal (also pluggable) | | Universal terminal | |
|-----------------------------|--------------------|----|-------------------------------------|----|--------------------|--|
| | L | L1 | U | | | |
| 1NC+1NO | 36.5 | 44 | - | | | |
| 2NC+2NO | 44 | - | - | | | |
| 3NC+3NO | 51.5 | - | - | | | |
| 4NC+4NO | 59 | - | - | | | |
| 1NC, 1NO, 1NC+1NO, 2NC, 2NO | | | | 44 | | |

17 Keylock switch actuator 2 positions, flush mounting page 15

| | Soldering terminal | | Soldering terminal (also pluggable) | | Universal terminal | |
|-----------------------------|--------------------|------|-------------------------------------|------|--------------------|--|
| | L | L1 | U | | | |
| 1NC+1NO | 35 | 44.5 | - | | | |
| 2NC+2NO | 42.5 | - | - | | | |
| 3NC+3NO | 50 | - | - | | | |
| 4NC+4NO | 57.5 | - | - | | | |
| 1NC, 1NO, 1NC+1NO, 2NC, 2NO | | | | 44.5 | | |

18 Selector switch actuator 2 positions, flush mounting page 19

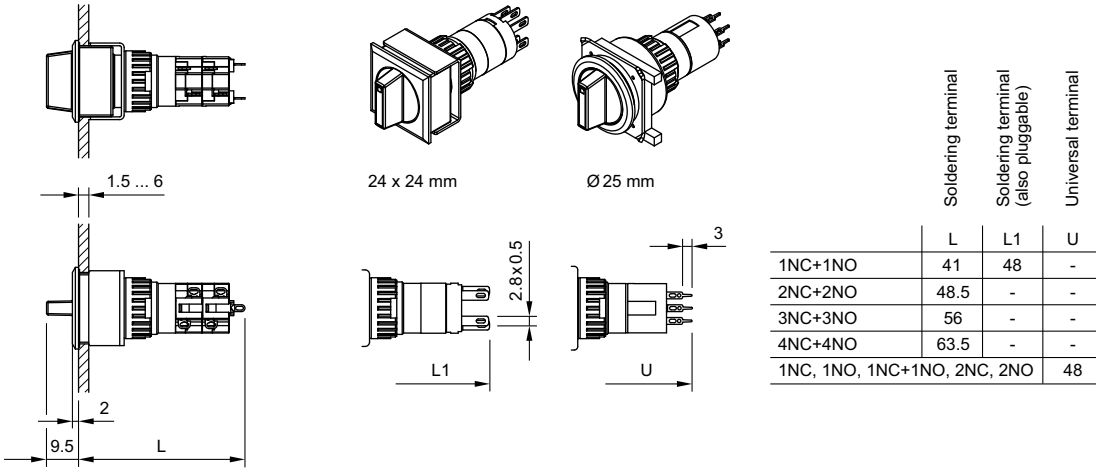

19 Selector switch 2 positions page 11

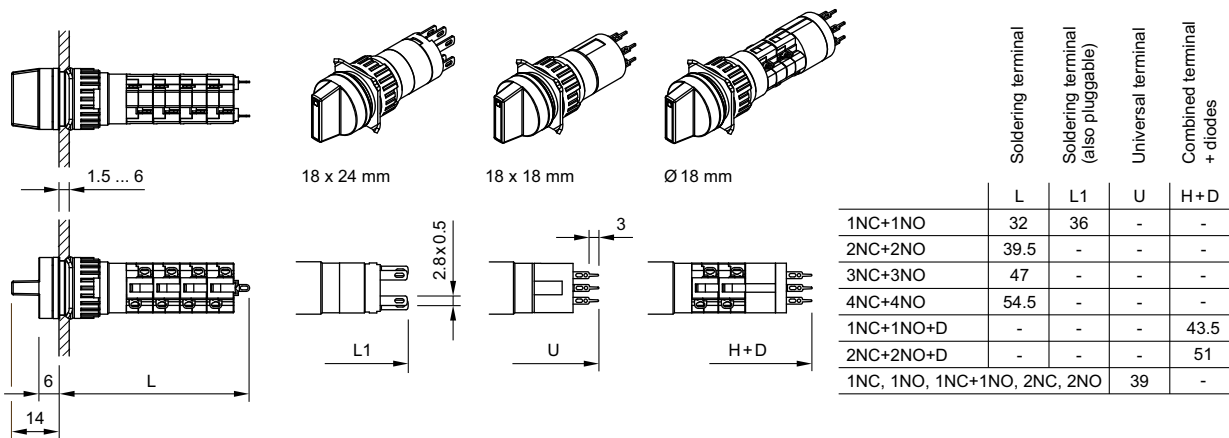

Circuit drawing

1 Indicator actuator page 7 | Indicator actuator, flush mounting page 13

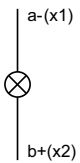

2 Illuminated pushbutton actuator page 8 | Illuminated pushbutton actuator, flush mounting page 14

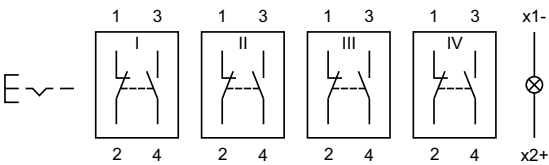

3 Illuminated pushbutton actuator page 8 | Illuminated pushbutton actuator, flush mounting page 14

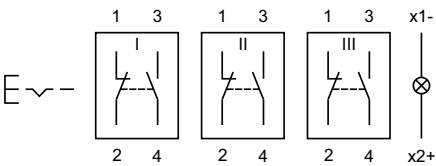

4 Illuminated pushbutton actuator page 8

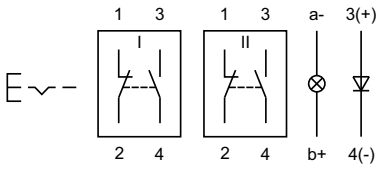

5 Illuminated pushbutton actuator page 8

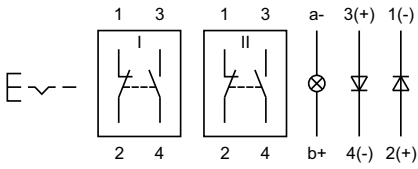

6 Illuminated pushbutton actuator page 8 | **Illuminated pushbutton actuator, flush mounting** page 14

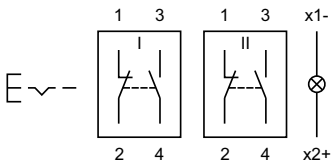

7 Illuminated pushbutton actuator page 8 | **Illuminated pushbutton actuator, flush mounting** page 14

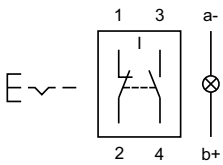

8 Illuminated pushbutton actuator page 8

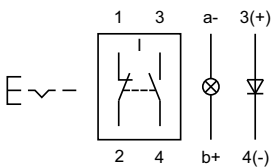

9 Illuminated pushbutton actuator page 8

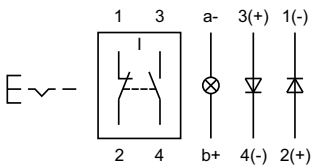

10 Illuminated pushbutton actuator page 8 | **Illuminated pushbutton actuator, flush mounting** page 14

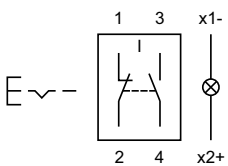

11 Illuminated pushbutton actuator page 8 | **Illuminated pushbutton actuator, flush mounting** page 14

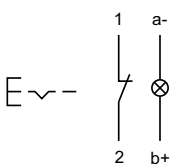

12 Illuminated pushbutton actuator page 8 | **Illuminated pushbutton actuator, flush mounting** page 14

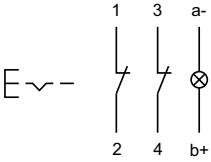

13 Illuminated pushbutton actuator page 8 | **Illuminated pushbutton actuator, flush mounting** page 14

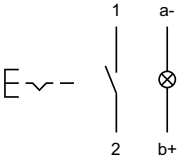

14 Illuminated pushbutton actuator page 8 | **Illuminated pushbutton actuator, flush mounting** page 14

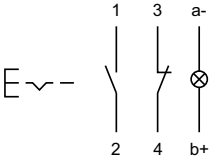

15 Illuminated pushbutton actuator page 8 | **Illuminated pushbutton actuator, flush mounting** page 14

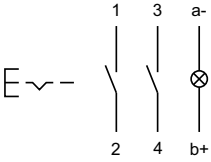

16 Selector switch 3 positions page 12 | **Selector switch actuator 3 positions, flush mounting** page 20

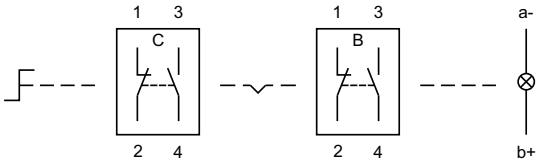

17 Selector switch 3 positions page 12 | **Selector switch actuator 3 positions, flush mounting** page 20

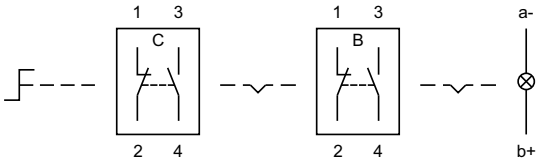

18 Selector switch 3 positions page 12 | **Selector switch actuator 3 positions, flush mounting** page 20

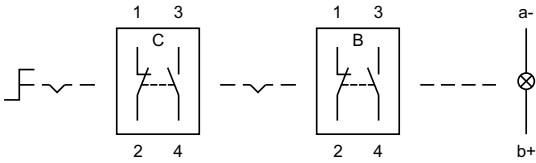

19 Selector switch 3 positions page 12 | **Selector switch actuator 3 positions, flush mounting** page 20

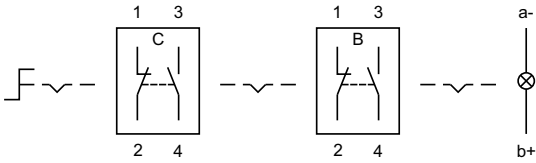

20 Selector switch 2 positions page 11 | Selector switch actuator 2 positions, flush mounting page 19

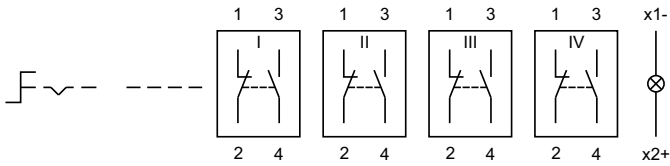

21 Selector switch 2 positions page 11 | Selector switch actuator 2 positions, flush mounting page 19

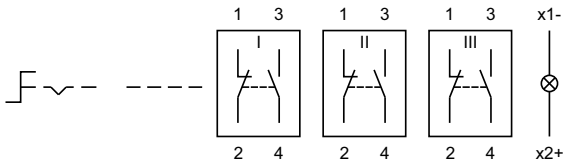

22 Selector switch 2 positions page 11

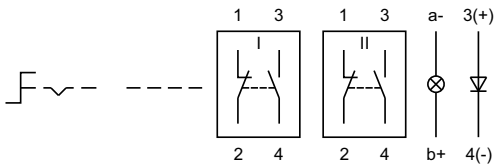

23 Selector switch 2 positions page 11

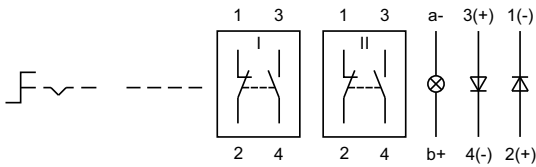

24 Selector switch 2 positions page 11 | Selector switch actuator 2 positions, flush mounting page 19

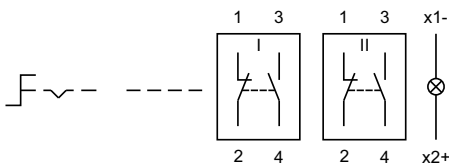

25 Selector switch 2 positions page 11 | Selector switch actuator 2 positions, flush mounting page 19

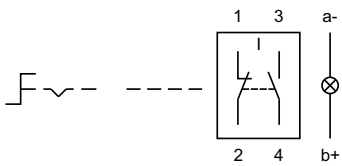

26 Selector switch 2 positions page 11

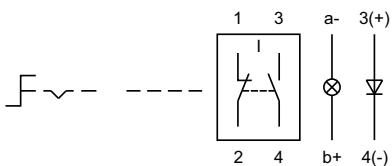

27 Selector switch 2 positions page 11

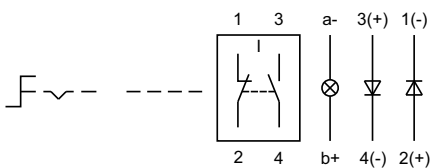

28 Selector switch 2 positions page 11 | Selector switch actuator 2 positions, flush mounting page 19

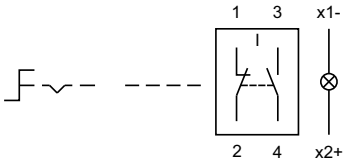

29 Selector switch 2 positions page 11 | Selector switch actuator 2 positions, flush mounting page 19

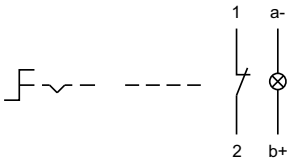

30 Selector switch 2 positions page 11 | Selector switch actuator 2 positions, flush mounting page 19

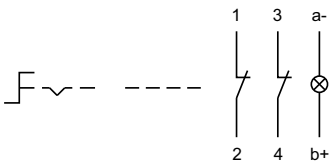

31 Selector switch 2 positions page 11 | Selector switch actuator 2 positions, flush mounting page 19

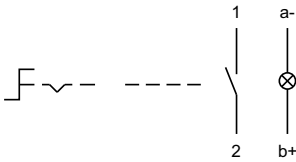

32 Selector switch 2 positions page 11 | Selector switch actuator 2 positions, flush mounting page 19

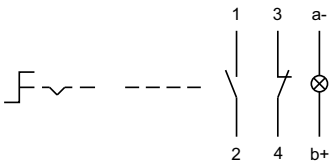

33 Selector switch 2 positions page 11 | Selector switch actuator 2 positions, flush mounting page 19

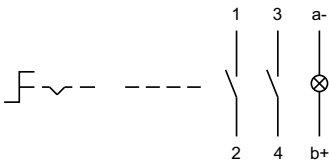

34 Selector switch 2 positions page 11 | Selector switch actuator 2 positions, flush mounting page 19

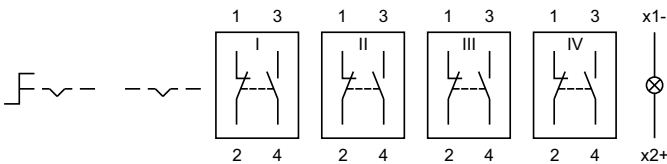

35 Selector switch 2 positions page 11 | Selector switch actuator 2 positions, flush mounting page 19

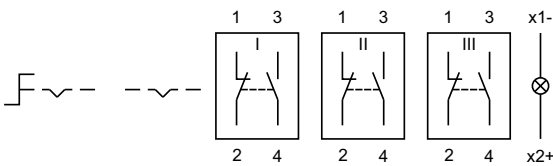

36 Selector switch 2 positions page 11

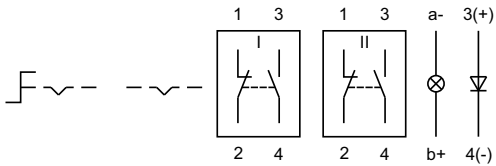

37 Selector switch 2 positions page 11

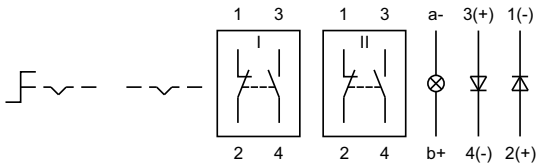

38 Selector switch 2 positions page 11 | Selector switch actuator 2 positions, flush mounting page 19

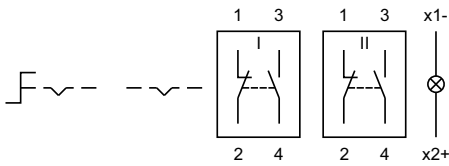

39 Selector switch 2 positions page 11 | Selector switch actuator 2 positions, flush mounting page 19

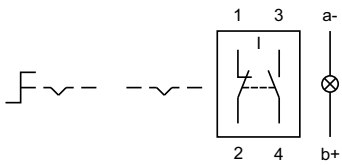

40 Selector switch 2 positions page 11

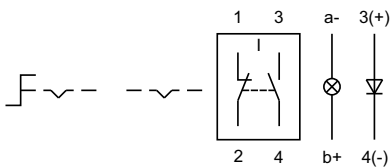

41 Selector switch 2 positions page 11

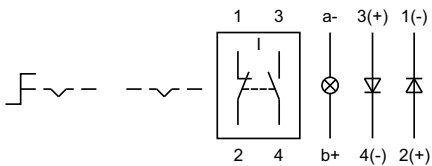

42 Selector switch 2 positions page 11 | Selector switch actuator 2 positions, flush mounting page 19

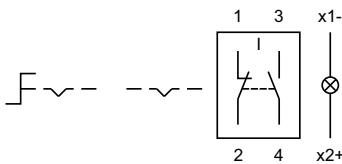

43 Selector switch 2 positions page 11 | Selector switch actuator 2 positions, flush mounting page 19

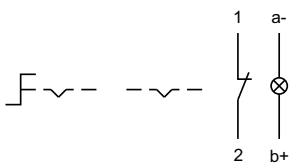

44 Selector switch 2 positions page 11 | Selector switch actuator 2 positions, flush mounting page 19

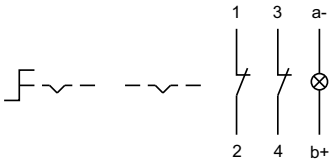

45 Selector switch 2 positions page 11 | Selector switch actuator 2 positions, flush mounting page 19

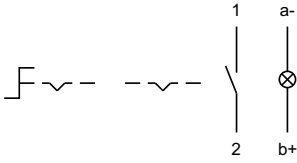

46 Selector switch 2 positions page 11 | Selector switch actuator 2 positions, flush mounting page 19

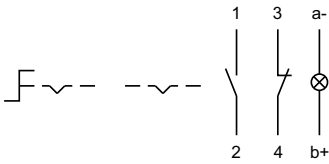

47 Selector switch 2 positions page 11 | Selector switch actuator 2 positions, flush mounting page 19

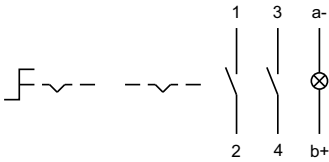

48 Illuminated pushbutton actuator page 8 | Illuminated pushbutton actuator, flush mounting page 14

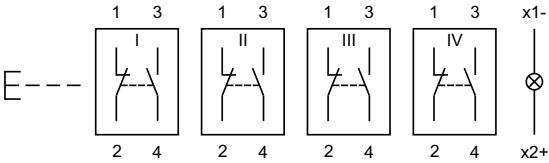

49 Illuminated pushbutton actuator page 8 | Illuminated pushbutton actuator, flush mounting page 14

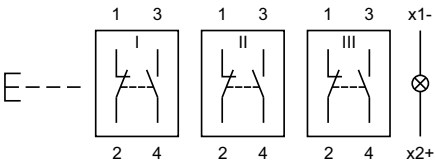

50 Illuminated pushbutton actuator page 8

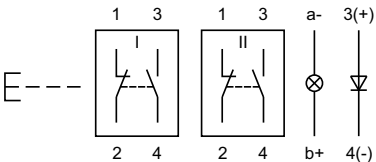

51 Illuminated pushbutton actuator page 8

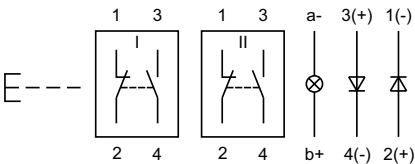

52 Illuminated pushbutton actuator page 8 | Illuminated pushbutton actuator, flush mounting page 14

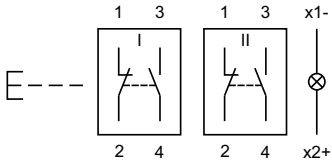

53 Illuminated pushbutton actuator page 8 | Illuminated pushbutton actuator, flush mounting page 14

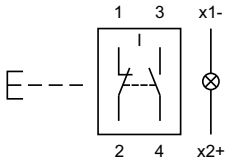

54 Illuminated pushbutton actuator page 8

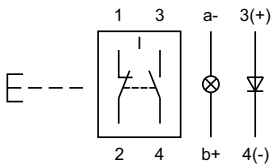

55 Illuminated pushbutton actuator page 8

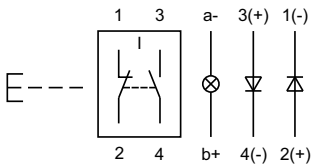

56 Illuminated pushbutton actuator page 8 | Illuminated pushbutton actuator, flush mounting page 14

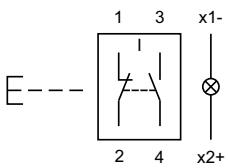

57 Illuminated pushbutton actuator page 8 | Illuminated pushbutton actuator, flush mounting page 14

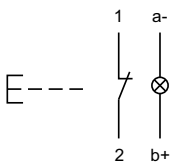

58 Illuminated pushbutton actuator page 8 | Illuminated pushbutton actuator, flush mounting page 14

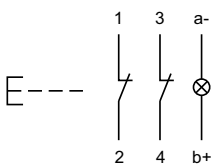

59 Illuminated pushbutton actuator page 8 | Illuminated pushbutton actuator, flush mounting page 14

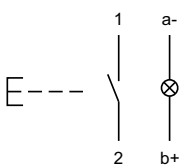

60 Illuminated pushbutton actuator page 8 | Illuminated pushbutton actuator, flush mounting page 14

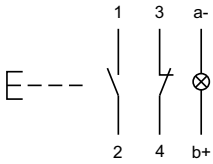

61 Illuminated pushbutton actuator page 8 | Illuminated pushbutton actuator, flush mounting page 14

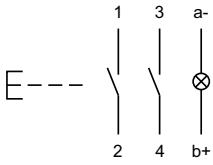

62 Keylock switch 3 positions page 10 | Keylock switch actuator 3 positions, flush mounting page 18

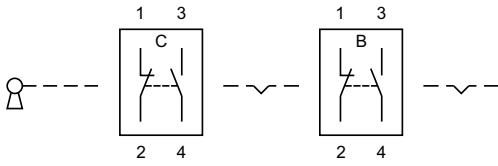

63 Keylock switch 3 positions page 10 | Keylock switch actuator 3 positions, flush mounting page 18

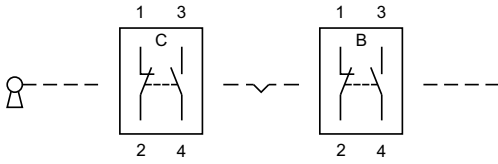

64 Keylock switch 3 positions page 10 | Keylock switch actuator 3 positions, flush mounting page 18

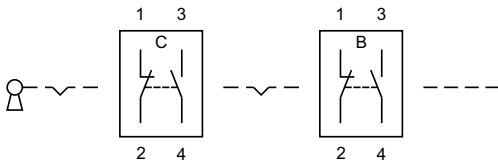

65 Keylock switch 3 positions page 10 | Keylock switch actuator 3 positions, flush mounting page 18

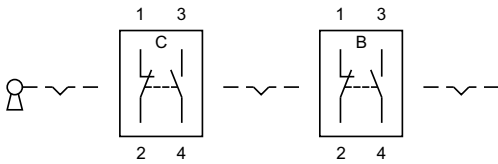

66 Keylock switch 2 positions page 9 | Keylock switch actuator 2 positions, flush mounting page 15

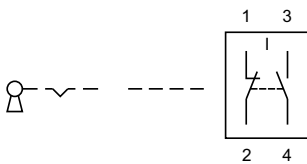

67 Keylock switch 2 positions page 9 | Keylock switch actuator 2 positions, flush mounting page 15

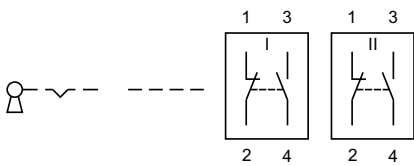

68 Keylock switch 2 positions page 9 | Keylock switch actuator 2 positions, flush mounting page 15

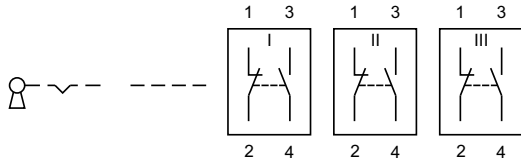

69 Keylock switch 2 positions page 9 | Keylock switch actuator 2 positions, flush mounting page 15

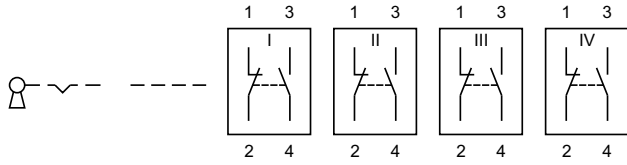

70 Keylock switch 2 positions page 9 | Keylock switch actuator 2 positions, flush mounting page 15

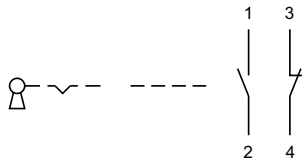

71 Keylock switch 2 positions page 9 | Keylock switch actuator 2 positions, flush mounting page 15



72 Keylock switch 2 positions page 9 | Keylock switch actuator 2 positions, flush mounting page 15

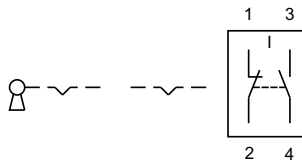

73 Keylock switch 2 positions page 9 | Keylock switch actuator 2 positions, flush mounting page 15

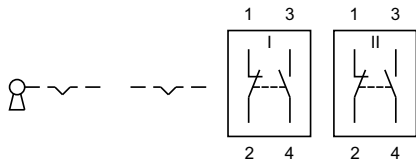

74 Keylock switch 2 positions page 9 | Keylock switch actuator 2 positions, flush mounting page 15

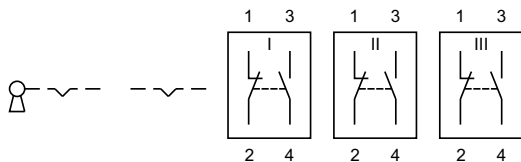

75 Keylock switch 2 positions page 9 | Keylock switch actuator 2 positions, flush mounting page 15

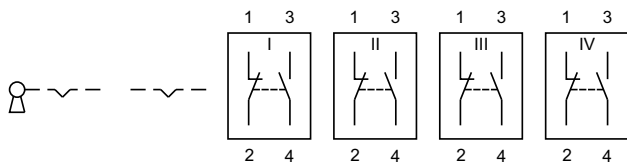

76 Keylock switch 2 positions page 9 | Keylock switch actuator 2 positions, flush mounting page 15

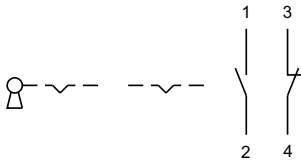

77 Keylock switch 2 positions page 9 | Keylock switch actuator 2 positions, flush mounting page 15

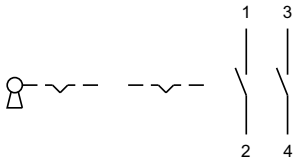

78 Indicator actuator page 7

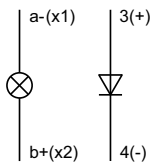

79 Indicator actuator page 7

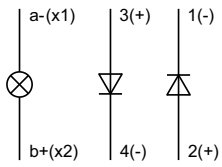

For Info: sales@switchesunlimited.com □ www.switchesunlimited.com □ Phone: 800-221-0487 □ Fax: 718-672-6370

Index from Typ-Nr.

| Typ-Nr. | Page | Typ-Nr. | Page | Typ-Nr. | Page |
|--------------|------|---------------|------|---------------|------|
| 01-907 | 31 | 51-040.002 | 7 | 51-156.025D2 | 9 |
| 01-928 | 29 | 51-040.005 | 7 | 51-156.025D2F | 15 |
| 01-929 | 29 | 51-041.006 | 7 | 51-157.025D2 | 9 |
| 02-904.0 | 30 | 51-050.002 | 7 | 51-157.025D2F | 15 |
| 02-904.1 | 30 | 51-050.002F | 13 | 51-158.025D2 | 9 |
| 02-904.3 | 30 | 51-050.005 | 7 | 51-158.025D2F | 15 |
| 02-904.7 | 30 | 51-050.005F | 13 | 51-195.022D | 9 |
| 02-905 | 31 | 51-051.006 | 7 | 51-195.022DF | 16 |
| 02-912.1 | 30 | 51-051.006F | 13 | 51-195.025D2 | 9 |
| 02-912.2 | 30 | 51-121.022 | 8 | 51-195.025D2F | 16 |
| 02-912.3 | 30 | 51-121.0252 | 8 | 51-196.025D2 | 9 |
| 02-912.4 | 30 | 51-122.0252 | 8 | 51-196.025D2F | 16 |
| 10-1306.1349 | 29 | 51-123.0252 | 8 | 51-197.025D2 | 9 |
| 10-1307.1369 | 29 | 51-124.0252 | 8 | 51-197.025D2F | 16 |
| 10-1309.1309 | 29 | 51-131.022 | 8 | 51-198.025D2 | 9 |
| 10-1310.1319 | 29 | 51-131.0252 | 8 | 51-198.025D2F | 16 |
| 10-1311.1249 | 29 | 51-132.0252 | 8 | 51-235.022D | 9 |
| 10-1312.1229 | 29 | 51-133.0252 | 8 | 51-235.022DF | 16 |
| 10-1313.1209 | 29 | 51-134.0252 | 8 | 51-235.025D2 | 9 |
| 10-1313.1249 | 29 | 51-135.022D | 9 | 51-235.025D2F | 16 |
| 10-1316.1179 | 29 | 51-135.022DF | 16 | 51-236.025D2 | 9 |
| 10-1316.1209 | 29 | 51-135.025D2 | 9 | 51-236.025D2F | 16 |
| 10-1319.1179 | 29 | 51-135.025D2F | 16 | 51-237.025D2 | 9 |
| 10-1319.1199 | 29 | 51-136.025D2 | 9 | 51-237.025D2F | 16 |
| 10-2J06.3142 | 30 | 51-136.025D2F | 16 | 51-238.025D2 | 9 |
| 10-2J06.3144 | 30 | 51-137.025D2 | 9 | 51-238.025D2F | 16 |
| 10-2J06.3145 | 30 | 51-137.025D2F | 16 | 51-255.022D | 9 |
| 10-2J06.3146 | 30 | 51-138.025D2 | 9 | 51-255.022DF | 15 |
| 10-2J06.3149 | 30 | 51-138.025D2F | 16 | 51-255.025D2 | 9 |
| 10-2J09.1062 | 30 | 51-141.022D | 9 | 51-255.025D2F | 15 |
| 10-2J09.1064 | 30 | 51-141.022DF | 17 | 51-256.025D2 | 9 |
| 10-2J09.1065 | 30 | 51-141.025D2 | 9 | 51-256.025D2F | 15 |
| 10-2J09.1066 | 30 | 51-141.025D2F | 17 | 51-257.025D2 | 9 |
| 10-2J09.1069 | 30 | 51-142.025D2 | 9 | 51-257.025D2F | 15 |
| 10-2J12.1062 | 30 | 51-142.025D2F | 17 | 51-258.025D2 | 9 |
| 10-2J12.1064 | 30 | 51-143.025D2 | 9 | 51-258.025D2F | 15 |
| 10-2J12.1065 | 30 | 51-143.025D2F | 17 | 51-261.022 | 8 |
| 10-2J12.1066 | 30 | 51-144.025D2 | 9 | 51-261.0252 | 8 |
| 10-2J12.1069 | 30 | 51-144.025D2F | 17 | 51-262.0252 | 8 |
| 10-2J13.1062 | 30 | 51-145.022D | 9 | 51-263.0252 | 8 |
| 10-2J13.1064 | 30 | 51-145.022DF | 15 | 51-264.0252 | 8 |
| 10-2J13.1065 | 30 | 51-145.025D2 | 9 | 51-271.022 | 8 |
| 10-2J13.1066 | 30 | 51-145.025D2F | 15 | 51-271.0252 | 8 |
| 10-2J13.1069 | 30 | 51-146.025D2 | 9 | 51-272.0252 | 8 |
| 10-2J19.1042 | 30 | 51-146.025D2F | 15 | 51-273.0252 | 8 |
| 10-2J19.1044 | 30 | 51-147.025D2 | 9 | 51-274.0252 | 8 |
| 10-2J19.1045 | 30 | 51-147.025D2F | 15 | 51-281.022 | 8 |
| 10-2J19.1046 | 30 | 51-148.025D2 | 9 | 51-281.022F | 14 |
| 10-2J19.1049 | 30 | 51-148.025D2F | 15 | 51-281.0252 | 8 |
| 31-928 | 29 | 51-151.022 | 8 | 51-281.0252F | 14 |
| 31-929 | 29 | 51-151.022F | 14 | 51-282.0252 | 8 |
| 31-940 | 28 | 51-151.0252 | 8 | 51-282.0252F | 14 |
| 31-941 | 28 | 51-151.0252F | 14 | 51-283.0252 | 8 |
| 31-942 | 28 | 51-152.0252 | 8 | 51-283.0252F | 14 |
| 31-945 | 29 | 51-152.0252F | 14 | 51-284.0252 | 8 |
| 31-946 | 29 | 51-153.0252 | 8 | 51-284.0252F | 14 |
| 31-985.0 | 28 | 51-153.0252F | 14 | 51-295.022D | 9 |
| 31-989.300 | 28 | 51-154.0252 | 8 | 51-295.022DF | 16 |
| 31-989.311 | 28 | 51-154.0252F | 14 | 51-295.025D2 | 9 |
| 31-991 | 31 | 51-155.022D | 9 | 51-295.025D2F | 16 |
| 51-030.002 | 7 | 51-155.022DF | 15 | 51-296.025D2 | 9 |
| 51-030.005 | 7 | 51-155.025D2 | 9 | 51-296.025D2F | 16 |
| 51-031.006 | 7 | 51-155.025D2F | 15 | 51-297.025D2 | 9 |

Index from Typ-Nr.

| Typ-Nr. | Page | Typ-Nr. | Page | Typ-Nr. | Page |
|---------------|------|---------------|------|---------------|------|
| 51-297.025D2F | 16 | 51-385.022D | 10 | 51-442.036DF | 15 |
| 51-298.025D2 | 9 | 51-385.022DF | 18 | 51-444.036D | 9 |
| 51-298.025D2F | 16 | 51-386.022D | 10 | 51-444.036DF | 15 |
| 51-335.022D | 9 | 51-386.022DF | 18 | 51-445.036D | 9 |
| 51-335.022DF | 16 | 51-387.022D | 10 | 51-445.036DF | 15 |
| 51-335.025D2 | 9 | 51-387.022DF | 18 | 51-447.036D | 9 |
| 51-335.025D2F | 16 | 51-388.022D | 10 | 51-447.036DF | 15 |
| 51-336.025D2 | 9 | 51-388.022DF | 18 | 51-448.036D | 9 |
| 51-336.025D2F | 16 | 51-395.022D | 9 | 51-448.036DF | 15 |
| 51-337.025D2 | 9 | 51-395.022DF | 16 | 51-451.036 | 8 |
| 51-337.025D2F | 16 | 51-395.025D2 | 9 | 51-451.036F | 14 |
| 51-338.025D2 | 9 | 51-395.025D2F | 16 | 51-452.036 | 8 |
| 51-338.025D2F | 16 | 51-396.025D2 | 9 | 51-452.036F | 14 |
| 51-355.022D | 9 | 51-396.025D2F | 16 | 51-453.036 | 8 |
| 51-355.022DF | 15 | 51-397.025D2 | 9 | 51-453.036F | 14 |
| 51-355.025D2 | 9 | 51-397.025D2F | 16 | 51-455.036 | 8 |
| 51-355.025D2F | 15 | 51-398.025D2 | 9 | 51-455.036F | 14 |
| 51-356.025D2 | 9 | 51-398.025D2F | 16 | 51-456.036 | 8 |
| 51-356.025D2F | 15 | 51-401.036D | 9 | 51-456.036F | 14 |
| 51-357.025D2 | 9 | 51-401.036DF | 16 | 51-457.036D | 9 |
| 51-357.025D2F | 15 | 51-402.036D | 9 | 51-457.036DF | 15 |
| 51-358.025D2 | 9 | 51-402.036DF | 16 | 51-458.036D | 9 |
| 51-358.025D2F | 15 | 51-404.036D | 9 | 51-458.036DF | 15 |
| 51-361.022D | 10 | 51-404.036DF | 16 | 51-461.036 | 8 |
| 51-361.022DF | 18 | 51-405.036D | 9 | 51-462.036 | 8 |
| 51-362.022D | 10 | 51-405.036DF | 16 | 51-463.036 | 8 |
| 51-362.022DF | 18 | 51-407.036D | 9 | 51-465.036 | 8 |
| 51-363.022D | 10 | 51-407.036DF | 16 | 51-466.036 | 8 |
| 51-363.022DF | 18 | 51-408.036D | 9 | 51-471.036 | 8 |
| 51-364.022D | 10 | 51-408.036DF | 16 | 51-472.036 | 8 |
| 51-364.022DF | 18 | 51-411.036D | 9 | 51-473.036 | 8 |
| 51-365.022D | 10 | 51-411.036DF | 16 | 51-475.036 | 8 |
| 51-365.022DF | 18 | 51-412.036D | 9 | 51-476.036 | 8 |
| 51-366.022D | 10 | 51-412.036DF | 16 | 51-481.036 | 8 |
| 51-366.022DF | 18 | 51-414.036D | 9 | 51-481.036F | 14 |
| 51-367.022D | 10 | 51-414.036DF | 16 | 51-482.036 | 8 |
| 51-367.022DF | 18 | 51-415.036D | 9 | 51-482.036F | 14 |
| 51-368.022D | 10 | 51-415.036DF | 16 | 51-483.036 | 8 |
| 51-368.022DF | 18 | 51-417.036D | 9 | 51-483.036F | 14 |
| 51-371.022D | 10 | 51-417.036DF | 16 | 51-485.036 | 8 |
| 51-371.022DF | 18 | 51-418.036D | 9 | 51-485.036F | 14 |
| 51-372.022D | 10 | 51-418.036DF | 16 | 51-486.036 | 8 |
| 51-372.022DF | 18 | 51-421.036 | 8 | 51-486.036F | 14 |
| 51-373.022D | 10 | 51-422.036 | 8 | 51-495.022D | 9 |
| 51-373.022DF | 18 | 51-423.036 | 8 | 51-495.022DF | 16 |
| 51-374.022D | 10 | 51-425.036 | 8 | 51-495.025D2 | 9 |
| 51-374.022DF | 18 | 51-426.036 | 8 | 51-495.025D2F | 16 |
| 51-375.022D | 10 | 51-427.036D | 9 | 51-496.025D2 | 9 |
| 51-375.022DF | 18 | 51-427.036DF | 16 | 51-496.025D2F | 16 |
| 51-376.022D | 10 | 51-428.036D | 9 | 51-497.025D2 | 9 |
| 51-376.022DF | 18 | 51-428.036DF | 16 | 51-497.025D2F | 16 |
| 51-377.022D | 10 | 51-431.036 | 8 | 51-498.025D2 | 9 |
| 51-377.022DF | 18 | 51-432.036 | 8 | 51-498.025D2F | 16 |
| 51-378.022D | 10 | 51-433.036 | 8 | 51-701.006 | 7 |
| 51-378.022DF | 18 | 51-435.036 | 8 | 51-702.006 | 7 |
| 51-381.022D | 10 | 51-436.036 | 8 | 51-703.006 | 7 |
| 51-381.022DF | 18 | 51-437.036D | 9 | 51-704.006 | 7 |
| 51-382.022D | 10 | 51-437.036DF | 17 | 51-705.0292 | 8 |
| 51-382.022DF | 18 | 51-438.036D | 9 | 51-706.0292 | 8 |
| 51-383.022D | 10 | 51-438.036DF | 17 | 51-707.0292 | 8 |
| 51-383.022DF | 18 | 51-441.036D | 9 | 51-708.0292 | 8 |
| 51-384.022D | 10 | 51-441.036DF | 15 | 51-709.0292 | 8 |
| 51-384.022DF | 18 | 51-442.036D | 9 | 51-710.0292 | 8 |

Index from Typ-Nr.

| Typ-Nr. | Page | Typ-Nr. | Page | Typ-Nr. | Page |
|-------------|------|-------------|------|-------------|------|
| 51-711.0292 | 8 | 51-933.4 | 21 | 52-432.036 | 19 |
| 51-712.0292 | 8 | 51-933.5 | 21 | 52-433.036 | 11 |
| 51-713.0292 | 8 | 51-933.6 | 21 | 52-433.036 | 19 |
| 51-714.0292 | 8 | 51-933.7 | 21 | 52-435.036 | 11 |
| 51-715.0292 | 8 | 51-935.2 | 21 | 52-435.036 | 19 |
| 51-716.0292 | 8 | 51-935.4 | 21 | 52-436.036 | 11 |
| 51-717.0292 | 8 | 51-935.5 | 21 | 52-436.036 | 19 |
| 51-718.0292 | 8 | 51-935.7 | 21 | 52-471.036 | 11 |
| 51-719.0292 | 8 | 51-938 | 31 | 52-471.036 | 19 |
| 51-720.0292 | 8 | 51-943.0 | 28 | 52-472.036 | 11 |
| 51-741.006 | 7 | 51-943.1 | 29 | 52-472.036 | 19 |
| 51-742.006 | 7 | 51-943.9 | 32 | 52-473.036 | 11 |
| 51-743.0292 | 8 | 51-947.0 | 27 | 52-473.036 | 19 |
| 51-744.0292 | 8 | 51-948.0 | 27 | 52-475.036 | 11 |
| 51-745.0292 | 8 | 51-949.0 | 27 | 52-475.036 | 19 |
| 51-746.0292 | 8 | 51-951.0 | 21 | 52-476.036 | 11 |
| 51-747.0292 | 8 | 51-951.2 | 21 | 52-476.036 | 19 |
| 51-748.0292 | 8 | 51-951.3 | 21 | 52-571.022A | 12 |
| 51-749.0292 | 8 | 51-951.4 | 21 | 52-571.022A | 20 |
| 51-750.0292 | 8 | 51-951.5 | 21 | 52-572.022A | 12 |
| 51-901.0 | 21 | 51-951.6 | 21 | 52-572.022A | 20 |
| 51-901.2 | 21 | 51-951.8 | 21 | 52-573.022A | 12 |
| 51-901.3 | 21 | 51-951.9 | 21 | 52-573.022A | 20 |
| 51-901.4 | 21 | 51-953.1 | 21 | 52-574.022A | 12 |
| 51-901.5 | 21 | 51-953.2 | 21 | 52-574.022A | 20 |
| 51-901.6 | 21 | 51-953.3 | 21 | 52-743.0292 | 11 |
| 51-901.8 | 21 | 51-953.4 | 21 | 52-744.0292 | 11 |
| 51-901.9 | 21 | 51-953.5 | 21 | 52-745.0292 | 11 |
| 51-903.1 | 21 | 51-953.6 | 21 | 52-746.0292 | 11 |
| 51-903.2 | 21 | 51-953.7 | 21 | 52-747.0292 | 11 |
| 51-903.3 | 21 | 51-954.2 | 21 | 52-748.0292 | 11 |
| 51-903.4 | 21 | 51-954.3 | 21 | 52-749.0292 | 11 |
| 51-903.5 | 21 | 51-954.4 | 21 | 52-750.0292 | 11 |
| 51-903.6 | 21 | 51-954.5 | 21 | 52-928.0 | 24 |
| 51-903.7 | 21 | 51-954.6 | 21 | 52-928.20 | 24 |
| 51-904.2 | 21 | 51-954.7 | 21 | 52-928.30 | 24 |
| 51-904.3 | 21 | 51-955.2 | 21 | 52-928.40 | 24 |
| 51-904.4 | 21 | 51-955.4 | 21 | 52-928.50 | 24 |
| 51-904.5 | 21 | 51-955.5 | 21 | 52-928.60 | 24 |
| 51-904.6 | 21 | 51-955.7 | 21 | 52-929.20 | 24 |
| 51-904.7 | 21 | 52-131.022 | 11 | 52-929.30 | 24 |
| 51-905.2 | 21 | 52-131.022 | 19 | 52-929.40 | 24 |
| 51-905.4 | 21 | 52-131.0252 | 11 | 52-929.50 | 24 |
| 51-905.5 | 21 | 52-131.0252 | 19 | 52-929.60 | 24 |
| 51-905.7 | 21 | 52-132.0252 | 11 | 52-929.8 | 24 |
| 51-906.2 | 21 | 52-132.0252 | 19 | 52-929.9 | 24 |
| 51-906.4 | 21 | 52-133.0252 | 11 | 52-950.0 | 23 |
| 51-906.5 | 21 | 52-133.0252 | 19 | 52-952.0 | 23 |
| 51-906.7 | 21 | 52-134.0252 | 11 | 61-9028.0 | 24 |
| 51-910 | 31 | 52-134.0252 | 19 | 61-9028.20 | 24 |
| 51-920 | 27 | 52-271.022 | 11 | 61-9028.30 | 24 |
| 51-925 | 27 | 52-271.022 | 19 | 61-9028.40 | 24 |
| 51-931.0 | 21 | 52-271.0252 | 11 | 61-9028.50 | 24 |
| 51-931.2 | 21 | 52-271.0252 | 19 | 61-9028.60 | 24 |
| 51-931.3 | 21 | 52-272.0252 | 11 | 61-9028.9 | 24 |
| 51-931.4 | 21 | 52-272.0252 | 19 | 61-9029.20 | 24 |
| 51-931.5 | 21 | 52-273.0252 | 11 | 61-9029.30 | 24 |
| 51-931.6 | 21 | 52-273.0252 | 19 | 61-9029.40 | 24 |
| 51-931.8 | 21 | 52-274.0252 | 11 | 61-9029.50 | 24 |
| 51-931.9 | 21 | 52-274.0252 | 19 | 61-9029.60 | 24 |
| 51-933.1 | 21 | 52-431.036 | 11 | 61-9029.8 | 24 |
| 51-933.2 | 21 | 52-431.036 | 19 | 61-9029.9 | 24 |
| 51-933.3 | 21 | 52-432.036 | 11 | 61-9451.0 | 27 |

Index from Typ-Nr.

| Typ-Nr. | Page | Typ-Nr. | Page | Typ-Nr. | Page |
|-------------|------|------------|------|---------|------|
| 61-9452.0 | 27 | 61-9842.2 | 23 | | |
| 61-9453.0 | 27 | 61-9842.4 | 23 | | |
| 61-9593.0 | 23 | 61-9842.5 | 23 | | |
| 61-9593.2 | 23 | 61-9842.6 | 23 | | |
| 61-9593.4 | 23 | 61-9842.8 | 23 | | |
| 61-9593.5 | 23 | 61-9921.0 | 27 | | |
| 61-9642.1 | 21 | 61-9922.0 | 27 | | |
| 61-9642.2 | 21 | 61-9924.0 | 27 | | |
| 61-9642.3 | 21 | 61-9927.2 | 26 | | |
| 61-9642.4 | 21 | 61-9930.0 | 25 | | |
| 61-9642.5 | 21 | 61-9930.0 | 26 | | |
| 61-9642.6 | 21 | 61-9930.4 | 25 | | |
| 61-9642.7 | 21 | 61-9930.4 | 26 | | |
| 61-9643.201 | 22 | 61-9931.0 | 25 | | |
| 61-9643.202 | 22 | 61-9931.0 | 26 | | |
| 61-9643.203 | 22 | 61-9931.4 | 25 | | |
| 61-9643.301 | 22 | 61-9931.4 | 26 | | |
| 61-9643.401 | 22 | 61-9932.0 | 26 | | |
| 61-9643.501 | 22 | 61-9932.0 | 26 | | |
| 61-9643.502 | 22 | 61-9932.1 | 26 | | |
| 61-9643.503 | 22 | 61-9932.1 | 26 | | |
| 61-9643.601 | 22 | 61-9932.10 | 26 | | |
| 61-9643.602 | 22 | 61-9932.10 | 26 | | |
| 61-9643.603 | 22 | 61-9932.2 | 26 | | |
| 61-9643.701 | 22 | 61-9932.2 | 26 | | |
| 61-9643.702 | 22 | 61-9932.4 | 26 | | |
| 61-9643.703 | 22 | 61-9932.4 | 26 | | |
| 61-9671.1 | 21 | 61-9932.5 | 26 | | |
| 61-9671.2 | 21 | 61-9932.5 | 26 | | |
| 61-9671.3 | 21 | 61-9932.6 | 26 | | |
| 61-9671.4 | 21 | 61-9932.6 | 26 | | |
| 61-9671.5 | 21 | 61-9933.0 | 25 | | |
| 61-9671.6 | 21 | 61-9933.0 | 25 | | |
| 61-9671.7 | 21 | 61-9933.1 | 25 | | |
| 61-9681.1 | 21 | 61-9933.1 | 25 | | |
| 61-9681.2 | 21 | 61-9933.10 | 25 | | |
| 61-9681.3 | 21 | 61-9933.10 | 25 | | |
| 61-9681.4 | 21 | 61-9933.2 | 25 | | |
| 61-9681.5 | 21 | 61-9933.2 | 25 | | |
| 61-9681.6 | 21 | 61-9933.4 | 25 | | |
| 61-9681.7 | 21 | 61-9933.4 | 25 | | |
| 61-9707.7 | 22 | 61-9933.5 | 25 | | |
| 61-9730.0 | 31 | 61-9933.5 | 25 | | |
| 61-9740.0 | 31 | 61-9933.6 | 25 | | |
| 61-9771.0 | 21 | 61-9933.6 | 25 | | |
| 61-9771.8 | 21 | 61-9934.8 | 25 | | |
| 61-9771.9 | 21 | 61-9936.0 | 26 | | |
| 61-9781.0 | 21 | 61-9980.0 | 24 | | |
| 61-9781.8 | 21 | 704.968.0 | 25 | | |
| 61-9781.9 | 21 | 704.968.1 | 25 | | |
| 61-9841.0 | 23 | 84-9103.7 | 26 | | |
| 61-9841.0A | 22 | | | | |
| 61-9841.2 | 23 | | | | |
| 61-9841.2A | 22 | | | | |
| 61-9841.4 | 23 | | | | |
| 61-9841.4A | 22 | | | | |
| 61-9841.5 | 23 | | | | |
| 61-9841.5A | 22 | | | | |
| 61-9841.6 | 23 | | | | |
| 61-9841.6A | 22 | | | | |
| 61-9841.8 | 23 | | | | |
| 61-9841.8A | 22 | | | | |
| 61-9842.0 | 23 | | | | |