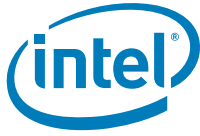


Intel[®] Pentium[®] 4 Processor 6x1^Δ Sequence

Datasheet

*– On 65 nm Process in the 775-land LGA Package supporting
Hyper-Threading Technology and Intel[®] 64 architecture*

January 2007



INFORMATION IN THIS DOCUMENT IS PROVIDED IN CONNECTION WITH INTEL PRODUCTS. NO LICENSE, EXPRESS OR IMPLIED, BY ESTOPPEL OR OTHERWISE, TO ANY INTELLECTUAL PROPERTY RIGHTS IS GRANTED BY THIS DOCUMENT. EXCEPT AS PROVIDED IN INTEL'S TERMS AND CONDITIONS OF SALE FOR SUCH PRODUCTS, INTEL ASSUMES NO LIABILITY WHATSOEVER, AND INTEL DISCLAIMS ANY EXPRESS OR IMPLIED WARRANTY, RELATING TO SALE AND/OR USE OF INTEL PRODUCTS INCLUDING LIABILITY OR WARRANTIES RELATING TO FITNESS FOR A PARTICULAR PURPOSE, MERCHANTABILITY, OR INFRINGEMENT OF ANY PATENT, COPYRIGHT OR OTHER INTELLECTUAL PROPERTY RIGHT. INTEL PRODUCTS ARE NOT INTENDED FOR USE IN MEDICAL, LIFE SAVING, OR LIFE SUSTAINING APPLICATIONS.

Intel may make changes to specifications and product descriptions at any time, without notice.

Designers must not rely on the absence or characteristics of any features or instructions marked "reserved" or "undefined." Intel reserves these for future definition and shall have no responsibility whatsoever for conflicts or incompatibilities arising from future changes to them.

The Intel® Pentium® 4 Processor 6x1 sequence may contain design defects or errors known as errata which may cause the product to deviate from published specifications.

Contact your local Intel sales office or your distributor to obtain the latest specifications and before placing your product order.

[^]Intel processor numbers are not a measure of performance. Processor numbers differentiate features within each processor family, not across different processor families. See http://www.intel.com/products/processor_number for details. Over time processor numbers will increment based on changes in clock, speed, cache, FSB, or other features, and increments are not intended to represent proportional or quantitative increases in any particular feature. Current roadmap processor number progression is not necessarily representative of future roadmaps. See www.intel.com/products/processor_number for details.

Intel® 64 requires a computer system with a processor, chipset, BIOS, operating system, device drivers, and applications enabled for Intel 64. Processor will not operate (including 32-bit operation) without an Intel 64-enabled BIOS. Performance will vary depending on your hardware and software configurations. See <http://www.intel.com/technology/intel64/index.htm> for more information including details on which processors support Intel 64, or consult with your system vendor for more information.

¹Hyper-Threading Technology requires a computer system with an Intel® Pentium® 4 processor supporting Hyper-Threading Technology and an HT Technology enabled chipset, BIOS, and an operating system. Performance will vary depending on the specific hardware and software you use. See http://www.intel.com/products/ht/hyperthreading_more.htm for information including details on which processors support HT Technology.

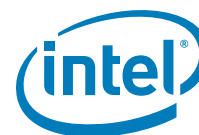
Enabling Execute Disable Bit functionality requires a PC with a processor with Execute Disable Bit capability and a supporting operating system. Check with your PC manufacturer on whether your system delivers Execute Disable Bit functionality.

Not all specified units of this processor support Enhanced HALT State and Enhanced Intel SpeedStep® Technology. See the Processor Spec Finder at <http://processorfinder.intel.com> or contact your Intel representative for more information.

Intel, Pentium, Intel NetBurst Intel SpeedStep, and the Intel logo are trademarks or registered trademarks of Intel Corporation or its subsidiaries in the United States and other countries.

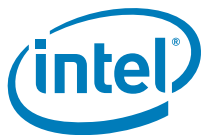
*Other names and brands may be claimed as the property of others.

Copyright © 2006 Intel Corporation.

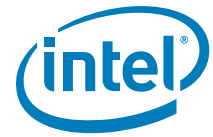


Contents

1	Introduction	9
1.1	Terminology	10
1.1.1	Processor Packaging Terminology	10
1.2	References	11
2	Electrical Specifications	13
2.1	Power and Ground Lands	13
2.2	Decoupling Guidelines	13
2.2.1	V _{CC} Decoupling	13
2.2.2	V _{TT} Decoupling	13
2.2.3	FSB Decoupling	14
2.3	Voltage Identification	14
2.4	Reserved, Unused, and TESTHI Signals	16
2.5	Voltage and Current Specification	17
2.5.1	Absolute Maximum and Minimum Ratings	17
2.5.2	DC Voltage and Current Specification	18
2.5.3	V _{CC} Overshoot	21
2.5.4	Die Voltage Validation	22
2.6	Signaling Specifications	22
2.6.1	FSB Signal Groups	23
2.6.2	GTL+ Asynchronous Signals	25
2.6.3	Processor DC Specifications	25
2.6.3.1	GTL+ Front Side Bus Specifications	28
2.7	Clock Specifications	29
2.7.1	Front Side Bus Clock (BCLK[1:0]) and Processor Clocking	29
2.7.2	FSB Frequency Select Signals (BSEL[2:0])	30
2.7.3	Phase Lock Loop (PLL) and Filter	30
2.7.4	BCLK[1:0] Specifications	32
3	Package Mechanical Specifications	33
3.1	Package Mechanical Drawing	33
3.2	Processor Component Keep-Out Zones	37
3.3	Package Loading Specifications	37
3.4	Package Handling Guidelines	37
3.5	Package Insertion Specifications	38
3.6	Processor Mass Specification	38
3.7	Processor Materials	38
3.8	Processor Markings	38
3.9	Processor Land Coordinates	39
4	Land Listing and Signal Descriptions	41
4.1	Processor Land Assignments	41
4.2	Alphabetical Signals Reference	64
5	Thermal Specifications and Design Considerations	75
5.1	Processor Thermal Specifications	75
5.1.1	Thermal Specifications	75
5.1.2	Thermal Metrology	79
5.2	Processor Thermal Features	79
5.2.1	Thermal Monitor	79
5.2.2	Thermal Monitor 2	80
5.2.3	On-Demand Mode	81
5.2.4	PROCHOT# Signal	82

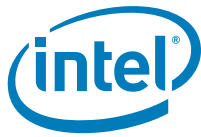


5.2.5	THERMTRIP# Signal	82
5.2.6	T _{CONTROL} and Fan Speed Reduction	82
5.2.7	Thermal Diode	82
6	Features	85
6.1	Power-On Configuration Options	85
6.2	Clock Control and Low Power States	85
6.2.1	Normal State	86
6.2.2	HALT and Enhanced HALT Powerdown States	86
6.2.2.1	HALT Powerdown State	86
6.2.2.2	Enhanced HALT Powerdown State	87
6.2.3	Stop Grant State	87
6.2.4	Enhanced HALT Snoop or HALT Snoop State, Stop Grant Snoop State	88
6.2.4.1	HALT Snoop State, Stop Grant Snoop State	88
6.2.4.2	Enhanced HALT Snoop State	88
7	Boxed Processor Specifications	89
7.1	Mechanical Specifications	89
7.1.1	Boxed Processor Cooling Solution Dimensions	89
7.1.2	Boxed Processor Fan Heatsink Weight	91
7.1.3	Boxed Processor Retention Mechanism and Heatsink Attach Clip Assembly	91
7.2	Electrical Requirements	91
7.2.1	Fan Heatsink Power Supply	91
7.3	Thermal Specifications	93
7.3.1	Boxed Processor Cooling Requirements	93
8	Balanced Technology Extended (BTX) Boxed Processor Specifications	95
8.1	Mechanical Specifications	96
8.1.1	Balanced Technology Extended (BTX) Type I and Type II Boxed Processor Cooling Solution Dimensions	96
8.1.2	Boxed Processor Thermal Module Assembly Weight	98
8.1.3	Boxed Processor Support and Retention Module (SRM)	98
8.2	Electrical Requirements	99
8.2.1	Thermal Module Assembly Power Supply	99
8.3	Thermal Specifications	101
8.3.1	Boxed Processor Cooling Requirements	101
8.3.2	Variable Speed Fan	102
9	Debug Tools Specifications	105
9.1	Logic Analyzer Interface (LAI)	105
9.1.1	Mechanical Considerations	105
9.1.2	Electrical Considerations	105



Figures

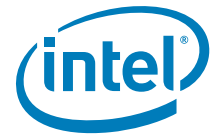
1	V_{CC} Static and Transient Tolerance for 775_VR_CONFIG_05A (Mainstream) and for 775_VR_CONFIG_06 Processors	21
2	V_{CC} Overshoot Example Waveform	22
3	Phase Lock Loop (PLL) Filter Requirements	31
4	Processor Package Assembly Sketch	33
5	Processor Package Drawing Sheet 1 of 3	34
6	Processor Package Drawing Sheet 2 of 3	35
7	Processor Package Drawing Sheet 3 of 3	36
8	Processor Top-Side Markings Example	38
9	Processor Land Coordinates and Quadrants (Top View)	39
10	land-out Diagram (Top View – Left Side)	42
11	land-out Diagram (Top View – Right Side)	43
12	Thermal Profile for 775_VR_CONFIG_05A Processors	77
13	Thermal Profile for 775_VR_CONFIG_06 Processors	78
14	Case Temperature (TC) Measurement Location	79
15	Thermal Monitor 2 Frequency and Voltage Ordering	81
16	Processor Low Power State Machine	86
17	Mechanical Representation of the Boxed Processor	89
18	Space Requirements for the Boxed Processor (Side View; applies to all four side views)	90
19	Space Requirements for the Boxed Processor (Top View)	90
20	Space Requirements for the Boxed Processor (Overall View)	91
21	Boxed Processor Fan Heatsink Power Cable Connector Description	92
22	Baseboard Power Header Placement Relative to Processor Socket	93
23	Boxed Processor Fan Heatsink Airspace Keep-out Requirements (Side 1 View)	94
24	Boxed Processor Fan Heatsink Airspace Keep-out Requirements (Side 2 View)	94
25	Mechanical Representation of the Boxed Processor with a Type I TMA	95
26	Mechanical Representation of the Boxed Processor with a Type II TMA	96
27	Requirements for the Balanced Technology Extended (BTX) Type I Keep-out Volumes	97
28	Requirements for the Balanced Technology Extended (BTX) Type II Keep-out Volume	98
29	Assembly Stack Including the Support and Retention Module	99
30	Boxed Processor TMA Power Cable Connector Description	100
31	Balanced Technology Extended (BTX) Mainboard Power Header Placement (Hatched Area)	101
32	Boxed Processor TMA Set Points	102



Tables

1	References	11
2	Voltage Identification Definition	15
3	Absolute Maximum and Minimum Ratings	17
4	Voltage and Current Specification	18
5	V _{CC} Static and Transient Tolerance for 775_VR_CONFIG_05A (Mainstream) and for 775_VR_CONFIG_06 Processors	20
6	V _{CC} Overshoot Specifications	21
7	FSB Signal Groups	23
8	Signal Characteristics	24
9	Signal Reference Voltages	24
10	GTL+ Signal Group DC Specifications	25
11	GTL+ Asynchronous Signal Group DC Specifications	25
12	PWRGOOD and TAP Signal Group DC Specifications	26
13	VTTWTRGD DC Specifications	27
14	BSEL[2:0] and VID[5:0] DC Specifications	27
15	BOOTSELECT DC Specifications	27
16	GTL+ Bus Voltage Definitions	28
17	Core Frequency to FSB Multiplier Configuration	29
18	BSEL[2:0] Frequency Table for BCLK[1:0]	30
19	Front Side Bus Differential BCLK Specifications	32
20	Processor Loading Specifications	37
21	Package Handling Guidelines	37
22	Processor Materials	38
23	Alphabetical Land Assignments	44
24	Numerical Land Assignment	54
25	Signal Description (Sheet 1 of 9)	64
26	Processor Thermal Specifications for 775_VR_CONFIG_05A Processors	76
27	Processor Thermal Specifications for 775_VR_CONFIG_06 Processors	76
28	Thermal Profile for 775_VR_CONFIG_05A Processors	77
29	Thermal Profile for 775_VR_CONFIG_06 Processors	78
30	Thermal "Diode" Parameters using Diode Model	83
31	Thermal "Diode" Parameters using Transistor Model	83
32	Thermal "Diode" n _{trim} and Diode_Correction_Offset	84
33	Thermal Diode Interface	84
34	Power-On Configuration Option Signals	85
35	Fan Heatsink Power and Signal Specifications	92
36	TMA Power and Signal Specifications	100
37	TMA Set Points for 3-wire operation of BTX Type I and Type II Boxed Processors	103

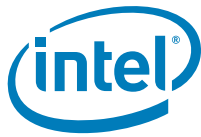
§



Revision History

Revision No.	Description	Date of Release
-001	<ul style="list-style-type: none">Initial release	January 2006
-002	<ul style="list-style-type: none">Added Intel Pentium 4 processor 651, 641, and 631 at 65 W.	January 2007

§

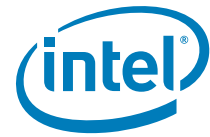


Intel® Pentium® 4 Processor 6x1 Sequence

- Available at 3.6 GHz, 3.40 GHz, 3.20 GHz, and 3 GHz
- Supports Hyper-Threading Technology¹ (HT Technology) for all frequencies with 800 MHz front side bus (FSB)
- Supports Intel® 64 architecture
- Supports Execute Disable Bit capability
- Binary compatible with applications running on previous members of the Intel microprocessor line
- Intel NetBurst® microarchitecture
- FSB frequency at 800 MHz
- Hyper-Pipelined Technology
- Advance Dynamic Execution
- Very deep out-of-order execution
- Enhanced branch prediction
- Optimized for 32-bit applications running on advanced 32-bit operating systems
- 16-KB Level 1 data cache
- 2-MB Advanced Transfer Cache (on-die, full-speed Level 2 (L2) cache) with 8-way associativity and Error Correcting Code (ECC)
- 144 Streaming SIMD Extensions 2 (SSE2) instructions
- 13 Streaming SIMD Extensions 3 (SSE3) instructions
- Enhanced floating point and multimedia unit for enhanced video, audio, encryption, and 3D performance
- Power Management capabilities
- System Management mode
- Multiple low-power states
- 8-way cache associativity provides improved cache hit rate on load/store operations
- 775-land Package

The Intel® Pentium® 4 processor family supporting Hyper-Threading Technology¹ (HT Technology) delivers Intel's advanced, powerful processors for desktop PCs and entry-level workstations that are based on the Intel NetBurst® microarchitecture. The Pentium 4 processor is designed to deliver performance across applications and usages where end-users can truly appreciate and experience the performance. These applications include Internet audio and streaming video, image processing, video content creation, speech, 3D, CAD, games, multimedia, and multitasking user environments. Intel® 64 architecture enables the Intel® Pentium® processor to execute operating systems and applications written to take advantage of the Intel 64 architecture.





1 Introduction

The Intel® Pentium® 4 processors 6x1 sequence are the first single-core desktop processors on the 65 nm process. The Pentium 4 processor uses Flip-Chip Land Grid Array (FC-LGA6) package technology, and plugs into a 775-land surface mount, Land Grid Array (LGA) socket, referred to as the LGA775 socket.

Note: In this document, unless otherwise specified, the Intel® Pentium® 4 processor 6x1 sequence refers to Intel Pentium 4 processors 661, 651, 641, 631.

Note: In this document the Intel® Pentium® 4 processor 6x1 sequence on 65 nm process in the 775-land package will be referred to as the “Pentium 4 processor,” or simply “the processor.”

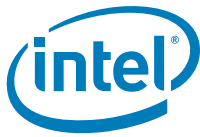
The Pentium 4 processor supports Intel® 64 architecture. This enhancement allows the processor to execute operating systems and applications written to take advantage of Intel 64 architecture. Further details on the 64-bit extension architecture and programming model are in the *Intel® Extended Memory 64 Technology Software Developer Guide* at <http://developer.intel.com/technology/64bitextensions/>.

The Pentium 4 processor supports Hyper-Threading Technology¹. Hyper-Threading Technology allows a single, physical processor to function as two logical processors. While some execution resources such as caches, execution units, and buses are shared, each logical processor has its own architecture state with its own set of general-purpose registers and control registers to provide increased system responsiveness in multitasking environments and headroom for next generation multithreaded applications. Intel recommends enabling Hyper-Threading Technology with Microsoft Windows* XP Professional or Windows* XP Home, and disabling Hyper-Threading Technology via the BIOS for all previous versions of Windows operating systems. For more information on Hyper-Threading Technology, see http://www.intel.com/products/ht/hyperthreading_more.htm. Refer to [Section 6.1](#) for Hyper-Threading Technology configuration details.

The Pentium 4 processor's Intel NetBurst® microarchitecture front side bus (FSB) uses a split-transaction, deferred reply protocol like previous Intel® Pentium® 4 processors. The Intel NetBurst microarchitecture FSB uses Source-Synchronous Transfer (SST) of address and data to improve performance by transferring data four times per bus clock (4X data transfer rate, as in AGP 4X). Along with the 4X data bus, the address bus can deliver addresses two times per bus clock and is referred to as a “double-clocked” or 2X address bus. Working together, the 4X data bus and 2X address bus provide a data bus bandwidth of up to 8.5 GB/s.

Intel will enable support components for the Pentium 4 processor including heatsink, heatsink retention mechanism, and socket. Manufacturability is a high priority; hence, mechanical assembly may be completed from the top of the baseboard and should not require any special tooling.

The Pentium 4 processor also include the Execute Disable Bit capability previously available in Intel® Itanium® processors. This feature, combined with a supported operating system, allows memory to be marked as executable or non-executable. If code attempts to run in non-executable memory the processor raises an error to the operating system. This feature can prevent some classes of viruses or worms that exploit buffer over run vulnerabilities and can thus help improve the overall security of the system. See the *Intel® 64 and IA-32 Architecture Software Developer's Manual* for more detailed information.



The processor includes an address bus powerdown capability that removes power from the address and data signals when the FSB is not in use. This feature is always enabled on the processor.

Enhanced Intel® SpeedStep® technology allows trade-offs to be made between performance and power consumptions. This may lower average power consumption (in conjunction with OS support).

1.1 Terminology

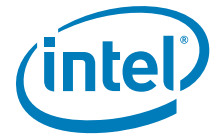
A '#' symbol after a signal name refers to an active low signal, indicating a signal is in the active state when driven to a low level. For example, when RESET# is low, a reset has been requested. Conversely, when NMI is high, a nonmaskable interrupt has occurred. In the case of signals where the name does not imply an active state but describes part of a binary sequence (such as *address* or *data*), the '#' symbol implies that the signal is inverted. For example, D[3:0] = 'HLHL' refers to a hex 'A', and D[3:0]# = 'LHLH' also refers to a hex 'A' (H= High logic level, L= Low logic level).

Front Side Bus refers to the interface between the processor and system core logic (a.k.a. the chipset components). The FSB is a multiprocessing interface to processors, memory, and I/O.

1.1.1 Processor Packaging Terminology

Commonly used terms are explained here for clarification:

- **Intel® Pentium® 4 processor on 65 nm process in the 775-land package** — Processor in the FC-LGA6 package with a 2 MB L2 cache.
- **Processor** — For this document, the term processor is the generic form of the Intel® Pentium® 4 processor 6x1 sequence on 65 nm process in the 775-land package.
- **Keep-out zone** — The area on or near the processor that system design can not utilize.
- **Intel® 945G/945GZ/945P/945PL Express chipsets** — Chipset that supports DDR and DDR2 memory technology for the Pentium 4 processor.
- **Processor core** — Processor core die with integrated L2 cache.
- **LGA775 socket** — The Pentium 4 processor mates with the system board through a surface mount, 775-land, LGA socket.
- **Integrated heat spreader (IHS)** — A component of the processor package used to enhance the thermal performance of the package. Component thermal solutions interface with the processor at the IHS surface.
- **Retention mechanism (RM)** — Since the LGA775 socket does not include any mechanical features for heatsink attach, a retention mechanism is required. Component thermal solutions should attach to the processor via a retention mechanism that is independent of the socket.
- **FSB (Front Side Bus)** — The electrical interface that connects the processor to the chipset. Also referred to as the processor system bus or the system bus. All memory and I/O transactions as well as interrupt messages pass between the processor and chipset over the FSB.
- **Storage conditions** — Refers to a non-operational state. The processor may be installed in a platform, in a tray, or loose. Processors may be sealed in packaging or exposed to free air. Under these conditions, processor lands should not be connected to any supply voltages, have any I/Os biased, or receive any clocks. Upon exposure to "free air" (i.e., unsealed packaging or a device removed from



packaging material) the processor must be handled in accordance with moisture sensitivity labeling (MSL) as indicated on the packaging material.

- **Functional operation** — Refers to normal operating conditions in which all processor specifications, including DC, AC, system bus, signal quality, mechanical and thermal are satisfied.

1.2 References

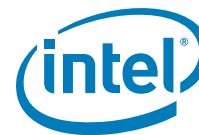
Material and concepts available in the following documents may be beneficial when reading this document.

Table 1. References

Document	Location
Intel® Pentium® 4 Processor 6x1 Sequence Specification Update	http://www.intel.com/design/pentium4/specupdt/310309.htm
<i>Intel® Pentium® D Processor, Intel® Pentium® Processor Extreme Edition, and Intel® Pentium® 4 Processor Thermal and Mechanical Design Guidelines</i> NOTE: Refer to this document for 86 W processors.	http://www.intel.com/design/pentiumXE/designex/306830.htm
<i>Intel® Core™2 Duo Desktop Processor E6000 Sequence and Intel® Pentium® 4 Processor 6x1 Sequence Thermal and Mechanical Design Guidelines</i> NOTE: Refer To this document for 65 W processors.	http://www.intel.com/design/processor/designex/313685.htm
<i>Voltage Regulator-Down (VRD) 11.0 Processor Power Delivery Design Guidelines For Desktop LGA775 Socket</i>	http://www.intel.com/design/Pentium4/guides/302356.htm
<i>LGA775 Socket Mechanical Design Guide</i>	http://www.intel.com/design/Pentium4/guides/302666.htm
<i>Balanced Technology Extended (BTX) System Design Guide</i>	http://www.formfactors.org
<i>Intel® 64 and IA-32 Architecture Software Developer's Manuals</i> <i>Volume 1: Basic Architecture</i> <i>Volume 2A: Instruction Set Reference, A-M</i> <i>Volume 2B: Instruction Set Reference, N-Z</i> <i>Volume 3A: System Programming Guide</i> <i>Volume 3B: System Programming Guide</i>	http://www.intel.com/products/processor/manuals/ http://www.intel.com/products/processor/manuals/ http://www.intel.com/products/processor/manuals/ http://www.intel.com/products/processor/manuals/ http://www.intel.com/products/processor/manuals/

§ §





2 Electrical Specifications

This chapter describes the electrical characteristics of the processor interfaces and signals. DC electrical characteristics are provided.

2.1 Power and Ground Lands

The Pentium 4 processor has 226 VCC (power), 24 VTT and 273 VSS (ground) inputs for on-chip power distribution. All power lands must be connected to V_{CC} , while all VSS lands must be connected to a system ground plane. The processor VCC lands must be supplied the voltage determined by the **V**oltage **I**Dentification (VID) lands.

Twenty-four (24) signals are denoted as VTT, that provide termination for the front side bus and power to the I/O buffers. A separate supply must be implemented for these lands, that meets the V_{TT} specifications outlined in [Table 4](#).

2.2 Decoupling Guidelines

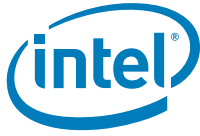
Due to its large number of transistors and high internal clock speeds, the processor is capable of generating large current swings. This may cause voltages on power planes to sag below their minimum specified values if bulk decoupling is not adequate. Larger bulk storage (C_{BULK}), such as electrolytic or aluminum-polymer capacitors, supply current during longer lasting changes in current demand by the component, such as coming out of an idle condition. Similarly, they act as a storage well for current when entering an idle condition from a running condition. The motherboard must be designed to ensure that the voltage provided to the processor remains within the specifications listed in [Table 4](#). Failure to do so can result in timing violations or reduced lifetime of the component.

2.2.1 V_{CC} Decoupling

V_{CC} regulator solutions need to provide sufficient decoupling capacitance to satisfy the processor voltage specifications. This includes bulk capacitance with low effective series resistance (ESR) to keep the voltage rail within specifications during large swings in load current. In addition, ceramic decoupling capacitors are required to filter high frequency content generated by the front side bus and processor activity. Consult the *Voltage Regulator-Down (VRD) 10.1 Design Guide For Desktop and Transportable LGA775 Socket* for further information.

2.2.2 V_{TT} Decoupling

Decoupling must be provided on the motherboard. Decoupling solutions must be sized to meet the expected load. To insure compliance with the specifications, various factors associated with the power delivery solution must be considered including regulator type, power plane and trace sizing, and component placement. A conservative decoupling solution would consist of a combination of low ESR bulk capacitors and high frequency ceramic capacitors.



2.2.3 FSB Decoupling

The processor integrates signal termination on the die. In addition, some of the high frequency capacitance required for the FSB is included on the processor package. However, additional high frequency capacitance must be added to the motherboard to properly decouple the return currents from the front side bus. Bulk decoupling must also be provided by the motherboard for proper [A]GTL+ bus operation.

2.3 Voltage Identification

The Voltage Identification (VID) specification for the processor is defined by the *Voltage Regulator-Down (VRD) 10.1 Design Guide For Desktop and Transportable LGA775 Socket*. The voltage set by the VID signals is the reference VR output voltage to be delivered to the processor VCC lands (see [Chapter 2.5.3](#) for V_{CC} overshoot specifications). Refer to [Table 14](#) for the DC specifications for these signals. A minimum voltage for each processor frequency is provided in [Table 4](#).

Individual processor VID values may be calibrated during manufacturing such that two devices at the same core speed may have different default VID settings. This is reflected by the VID Range values provided in [Table 4](#). Refer to the *Intel® Pentium® 4 Processor Specification Update* for further details on specific valid core frequency and VID values of the processor. Note that this differs from the VID employed by the processor during a power management event (Thermal Monitor 2, Enhanced Intel SpeedStep technology, or Enhanced HALT State).

The processor uses 6 voltage identification signals, VID[5:0], to support automatic selection of power supply voltages. [Table 2](#) specifies the voltage level corresponding to the state of VID[5:0]. A '1' in this table refers to a high voltage level and a '0' refers to a low voltage level. If the processor socket is empty (VID[5:0] = x11111), or the voltage regulation circuit cannot supply the voltage that is requested, it must disable itself. See the *Voltage Regulator-Down (VRD) 10.1 Design Guide For Desktop and Transportable LGA775 Socket* for further details.

The processor provides the ability to operate while transitioning to an adjacent VID and its associated processor core voltage (V_{CC}). This will represent a DC shift in the load line. It should be noted that a low-to-high or high-to-low voltage state change may result in as many VID transitions as necessary to reach the target core voltage. Transitions above the specified VID are not permitted. [Table 4](#) includes VID step sizes and DC shift ranges. Minimum and maximum voltages must be maintained as shown in [Table 5](#) and [Figure 1](#) as measured across the VCC_SENSE and VSS_SENSE lands.

The VRM or VRD used must be capable of regulating its output to the value defined by the new VID. DC specifications for dynamic VID transitions are included in [Table 4](#) and [Table 5](#). Refer to the *Voltage Regulator-Down (VRD) 10.1 Design Guide For Desktop and Transportable LGA775 Socket* for further details.

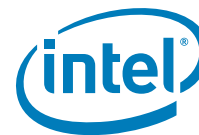
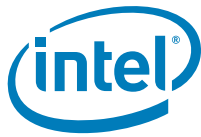


Table 2. Voltage Identification Definition

VID5	VID4	VID3	VID2	VID1	VID0	VID
0	0	1	0	1	0	0.8375
1	0	1	0	0	1	0.8500
0	0	1	0	0	1	0.8625
1	0	1	0	0	0	0.8750
0	0	1	0	0	0	0.8875
1	0	0	1	1	1	0.9000
0	0	0	1	1	1	0.9125
1	0	0	1	1	0	0.9250
0	0	0	1	1	0	0.9375
1	0	0	1	0	1	0.9500
0	0	0	1	0	1	0.9625
1	0	0	1	0	0	0.9750
0	0	0	1	0	0	0.9875
1	0	0	0	1	1	1.0000
0	0	0	0	1	1	1.0125
1	0	0	0	1	0	1.0250
0	0	0	0	1	0	1.0375
1	0	0	0	0	1	1.0500
0	0	0	0	0	1	1.0625
1	0	0	0	0	0	1.0750
0	0	0	0	0	0	1.0875
1	1	1	1	1	1	VR output off
0	1	1	1	1	1	VR output off
1	1	1	1	1	0	1.1000
0	1	1	1	1	0	1.1125
1	1	1	1	0	1	1.1250
0	1	1	1	0	1	1.1375
1	1	1	1	0	0	1.1500
0	1	1	1	0	0	1.1625
1	1	1	0	1	1	1.1750
0	1	1	0	1	1	1.1875
1	1	1	0	1	0	1.2000

VID5	VID4	VID3	VID2	VID1	VID0	VID
0	1	1	0	1	0	1.2125
1	1	1	0	0	1	1.2250
0	1	1	0	0	1	1.2375
1	1	1	0	0	0	1.2500
0	1	1	0	0	0	1.2625
1	1	0	1	1	1	1.2750
0	1	0	1	1	1	1.2875
1	1	0	1	1	0	1.3000
0	1	0	1	1	0	1.3125
1	1	0	1	0	1	1.3250
0	1	0	1	0	1	1.3375
1	1	0	1	0	0	1.3500
0	1	0	1	0	0	1.3625
1	1	0	0	1	1	1.3750
0	1	0	0	1	1	1.3875
1	1	0	0	1	0	1.4000
0	1	0	0	1	0	1.4125
1	1	0	0	0	1	1.4250
0	1	0	0	0	1	1.4375
1	1	0	0	0	0	1.4500
0	1	0	0	0	0	1.4625
1	0	1	1	1	1	1.4750
0	0	1	1	1	1	1.4875
1	0	1	1	1	0	1.5000
0	0	1	1	1	0	1.5125
1	0	1	1	0	1	1.5250
0	0	1	1	0	1	1.5375
1	0	1	1	0	0	1.5500
0	0	1	1	0	0	1.5625
1	0	1	0	1	1	1.5750
0	0	1	0	1	1	1.5875
1	0	1	0	1	0	1.6000



2.4 Reserved, Unused, and TESTHI Signals

All RESERVED lands must remain unconnected. Connection of these lands to V_{CC} , V_{SS} , V_{TT} , or to any other signal (including each other) can result in component malfunction or incompatibility with future processors. See [Chapter 4](#) for a land listing of the processor and the location of all RESERVED lands.

In a system level design, on-die termination has been included by the processor to allow signals to be terminated within the processor silicon. Most unused GTL+ inputs should be left as no connects as GTL+ termination is provided on the processor silicon. However, see [Table 7](#) for details on GTL+ signals that do not include on-die termination.

Unused active high inputs, should be connected through a resistor to ground (V_{SS}). Unused outputs can be left unconnected; however, this may interfere with some TAP functions, complicate debug probing, and prevent boundary scan testing. A resistor must be used when tying bidirectional signals to power or ground. When tying any signal to power or ground, a resistor will also allow for system testability. Resistor values should be within $\pm 20\%$ of the impedance of the motherboard trace for front side bus signals. For unused GTL+ input or I/O signals, use pull-up resistors of the same value as the on-die termination resistors (RT_T). For details, see [Table 16](#).

TAP, GTL+ Asynchronous inputs, and GTL+ Asynchronous outputs do not include on-die termination. Inputs and utilized outputs must be terminated on the motherboard. Unused outputs may be terminated on the motherboard or left unconnected. Note that leaving unused outputs unterminated may interfere with some TAP functions, complicate debug probing, and prevent boundary scan testing.

All TESTHI[13:0] lands should be individually connected to V_{TT} via a pull-up resistor that matches the nominal trace impedance.

The TESTHI signals may use individual pull-up resistors or be grouped together as detailed below. A matched resistor must be used for each group:

- TESTHI[1:0]
- TESTHI[7:2]
- TESTHI8 – cannot be grouped with other TESTHI signals
- TESTHI9 – cannot be grouped with other TESTHI signals
- TESTHI10 – cannot be grouped with other TESTHI signals
- TESTHI11 – cannot be grouped with other TESTHI signals
- TESTHI12 – cannot be grouped with other TESTHI signals
- TESTHI13 – cannot be grouped with other TESTHI signals

However, using boundary scan test will not be functional if these lands are connected together. For optimum noise margin, all pull-up resistor values used for TESTHI[13:0] lands should have a resistance value within $\pm 20\%$ of the impedance of the board transmission line traces. For example, if the nominal trace impedance is $50\ \Omega$, then a value between $40\ \Omega$ and $60\ \Omega$ should be used.



2.5 Voltage and Current Specification

2.5.1 Absolute Maximum and Minimum Ratings

Table 3 specifies absolute maximum and minimum ratings. Within functional operation limits, functionality and long-term reliability can be expected.

At conditions outside functional operation condition limits, but within absolute maximum and minimum ratings, neither functionality nor long-term reliability can be expected. If a device is returned to conditions within functional operation limits after having been subjected to conditions outside these limits, but within the absolute maximum and minimum ratings, the device may be functional, but with its lifetime degraded depending on exposure to conditions exceeding the functional operation condition limits.

At conditions exceeding absolute maximum and minimum ratings, neither functionality nor long-term reliability can be expected. Moreover, if a device is subjected to these conditions for any length of time then, when returned to conditions within the functional operating condition limits, it will either not function, or its reliability will be severely degraded.

Although the processor contains protective circuitry to resist damage from static electric discharge, precautions should always be taken to avoid high static voltages or electric fields.

Table 3. Absolute Maximum and Minimum Ratings

Symbol	Parameter	Min	Max	Unit	Notes ^{1,2}
V_{CC}	Core voltage with respect to V_{SS}	-0.3	1.55	V	
V_{TT}	FSB termination voltage with respect to V_{SS}	-0.3	1.55	V	
T_c	Processor case temperature	See Chapter 5	See Chapter 5	°C	
$T_{STORAGE}$	Processor storage temperature	-40	85	°C	3, 4, 5

NOTES:

1. For functional operation, all processor electrical, signal quality, mechanical and thermal specifications must be satisfied.
2. Excessive overshoot or undershoot on any signal will likely result in permanent damage to the processor.
3. Storage temperature is applicable to storage conditions only. In this scenario, the processor must not receive a clock, and no lands can be connected to a voltage bias. Storage within these limits will not affect the long-term reliability of the device. For functional operation, refer to the processor case temperature specifications.
4. This rating applies to the processor and does not include any tray or packaging.
5. Failure to adhere to this specification can affect the long term reliability of the processor.



2.5.2 DC Voltage and Current Specification

Table 4. Voltage and Current Specification

Symbol	Parameter		Min	Typ	Max	Unit	Notes ^{1, 2}
VID Range	VID		1.200	—	1.3375	V	³
V _{CC}	Processor number	V _{CC} for 775_VR_CONFIG_05A	Refer to Table 5 and Figure 1			V	4, 5, 6
	661	3.6 GHz					
	651	3.4 GHz					
	641	3.2 GHz					
631	3 GHz						
I _{CC}	Processor number	I _{CC} for 775_VR_CONFIG_05A	—	—	100	A	⁷
	661	3.6 GHz					
	651	3.4 GHz					
	641	3.2 GHz					
	631	3 GHz					
	Processor number	I _{CC} for 775_VR_CONFIG_06	—	—	65		
651	3.4 GHz						
641	3.2 GHz						
631	3 GHz						
I _{SGNT}	Processor number	I _{CC} Stop-Grant for 775_VR_CONFIG_05A	—	—	50	A	8,9,10,11
	661	3.6 GHz					
	651	3.4 GHz					
	641	3.2 GHz					
	631	3 GHz					
	Processor number	I _{CC} Stop-Grant for 775_VR_CONFIG_06			40		
651	3.4 GHz						
641	3.2 GHz						
631	3 GHz						
I _{ENHANCED_AUTO_HALT}	Processor number	I _{CC} Enhanced Halt for 775_VR_CONFIG_05A			40	A	8,10,11
	661	3.6 GHz					
	651	3.4 GHz					
	641	3.2 GHz					
	631	3 GHz					
	Processor number	I _{CC} Enhanced Auto HALT for 775_VR_CONFIG_06			25		
651	3.4 GHz						
641	3.2 GHz						
631	3 GHz						
I _{TCC}	I _{CC} TCC active		—	—	I _{CC}	A	¹²
V _{TT}	FSB termination voltage (DC + AC specifications)		1.14	1.20	1.26	V	13, 14

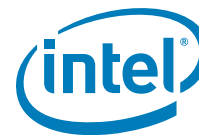
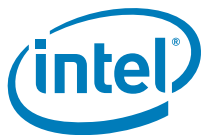


Table 4. Voltage and Current Specification

Symbol	Parameter	Min	Typ	Max	Unit	Notes ^{1, 2}
VTT_OUT_LEFT and VTT_OUT_RIGHT I_{CC}	DC Current that may be drawn from VTT_OUT_LEFT and VTT_OUT_RIGHT per pin	—	—	580	mA	
I_{TT}	Steady-state FSB termination current	—	—	3.5	A	15, 16
$I_{TT_POWER-UP}$	Power-up FSB termination current	—	—	4.5	A	15, 17
I_{CC_VCCA}	I_{CC} for PLL lands	—	—	35	mA	
$I_{CC_VCCIOPLL}$	I_{CC} for I/O PLL land	—	—	26	mA	
I_{CC_GTLREF}	I_{CC} for GTLREF	—	—	200	μ A	

NOTES:

- Unless otherwise noted, all specifications in this table are based on estimates and simulations or empirical data. These specifications will be updated with characterized data from silicon measurements at a later date.
- Adherence to the voltage specifications for the processor are required to ensure reliable processor operation.
- Each processor is programmed with a maximum valid voltage identification value (VID) that is set at manufacturing and can not be altered. Individual maximum VID values are calibrated during manufacturing such that two processors at the same frequency may have different settings within the VID range. Note that this differs from the VID employed by the processor during a power management event (Thermal Monitor 2, Enhanced Intel SpeedStep technology, or Enhanced HALT State).
- These voltages are targets only. A variable voltage source should exist on systems in the event that a different voltage is required. See Section 2.3 and Table 2 for more information.
- The voltage specification requirements are measured across VCC_SENSE and VSS_SENSE lands at the socket with a 100 MHz bandwidth oscilloscope, 1.5 pF maximum probe capacitance, and 1 M Ω minimum impedance. The maximum length of ground wire on the probe should be less than 5 mm. Ensure external noise from the system is not coupled into the oscilloscope probe.
- Refer to Table 5 and Figure 1 for the minimum, typical, and maximum V_{CC} allowed for a given current. The processor should not be subjected to any V_{CC} and I_{CC} combination wherein V_{CC} exceeds V_{CC_MAX} for a given current.
- I_{CC_MAX} is specified at V_{CC_MAX} .
- The current specified is also for AutoHALT State.
- I_{CC} Stop-Grant is specified at V_{CC_MAX} .
- I_{SGNT} and $I_{ENHANCED_AUTO_HALT}$ are specified at V_{CC_TYP} and $TC = 50$ °C.
- These parameters are based on design characterization and are not tested.
- The maximum instantaneous current the processor will draw while the thermal control circuit is active (as indicated by the assertion of PROCHOT#) is the same as the maximum I_{CC} for the processor.
- V_{TT} must be provided via a separate voltage source and not be connected to V_{CC} . This specification is measured at the land.
- Baseboard bandwidth is limited to 20 MHz.
- This is maximum total current drawn from V_{TT} plane by only the processor. This specification does not include the current coming from R_{TT} (through the signal line). Refer to the *Voltage Regulator-Down (VRD) 10.1 Design Guide For Desktop and Transportable LGA775 Socket* to determine the total I_{TT} drawn by the system.
- This is a steady-state I_{TT} current specification, which is applicable when both V_{TT} and V_{CC} are high.
- This is a power-up peak current specification that is applicable when V_{TT} is high and V_{CC} is low.

Table 5. V_{CC} Static and Transient Tolerance for 775_VR_CONFIG_05A (Mainstream) and for 775_VR_CONFIG_06 Processors

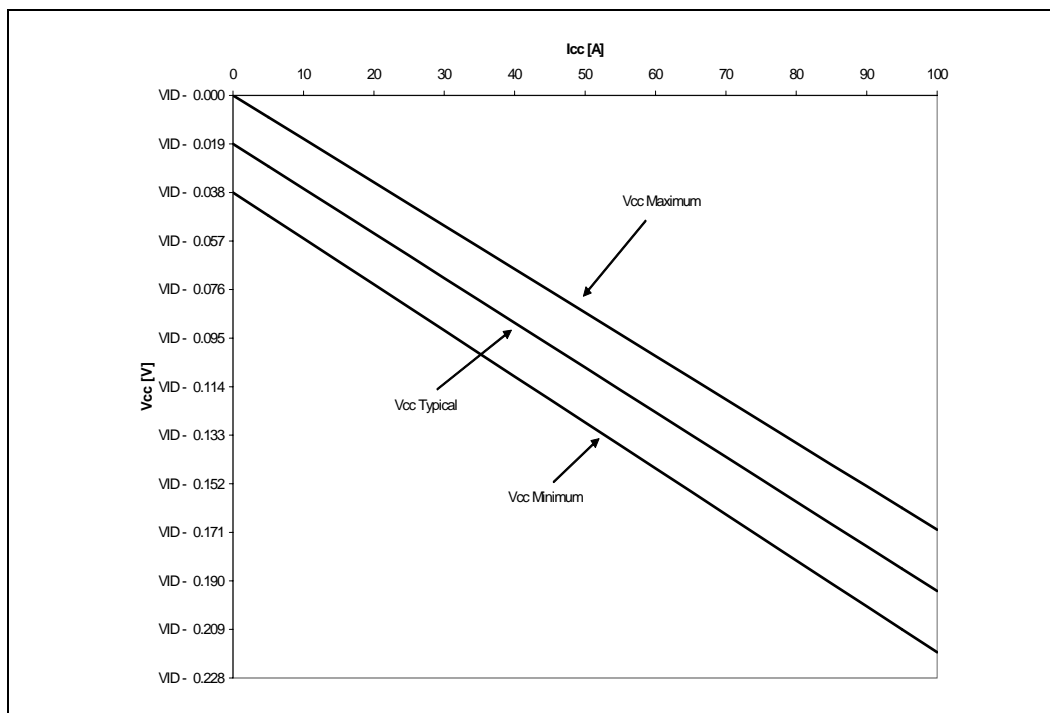
I_{CC} (A)	Voltage Deviation from VID Setting (V) ^{1,2,3,4}		
	Maximum Voltage 1.7 m Ω	Typical Voltage 1.75 m Ω	Minimum Voltage 1.8 m Ω
0	0.000	-0.019	-0.038
5	-0.009	-0.028	-0.047
10	-0.017	-0.037	-0.056
15	-0.026	-0.045	-0.065
20	-0.034	-0.054	-0.074
25	-0.043	-0.063	-0.083
30	-0.051	-0.072	-0.092
35	-0.060	-0.080	-0.101
40	-0.068	-0.089	-0.110
45	-0.077	-0.098	-0.119
50	-0.085	-0.107	-0.128
55	-0.094	-0.115	-0.137
60	-0.102	-0.124	-0.146
65	-0.111	-0.133	-0.155
70	-0.119	-0.142	-0.164
75	-0.128	-0.150	-0.173
80	-0.133	-0.156	-0.178
85	-0.145	-0.168	-0.191
90	-0.153	-0.177	-0.200
95	-0.162	-0.185	-0.209
100	-0.170	-0.194	-0.218

NOTES:

1. The loadline specification includes both static and transient limits except for overshoot allowed as shown in [Section 2.5.3](#).
2. This table is intended to aid in reading discrete points on [Figure 1](#).
3. The loadlines specify voltage limits at the die measured at the VCC_SENSE and VSS_SENSE lands. Voltage regulation feedback for voltage regulator circuits must be taken from processor VCC and VSS lands. Refer to the *Voltage Regulator-Down (VRD) 10.1 Design Guide For Desktop and Transportable LGA775 Socket* for socket loadline guidelines and VR implementation details.
4. Adherence to this loadline specification for the Pentium 4 processor is required to ensure reliable processor operation.



Figure 1. V_{CC} Static and Transient Tolerance for 775_VR_CONFIG_05A (Mainstream) and for 775_VR_CONFIG_06 Processors



NOTES:

1. The loadline specification includes both static and transient limits except for overshoot allowed as shown in Section 2.5.3.
2. This loadline specification shows the deviation from the VID set point.
3. The loadlines specify voltage limits at the die measured at the VCC_SENSE and VSS_SENSE lands. Voltage regulation feedback for voltage regulator circuits must be taken from processor VCC and VSS lands. Refer to the *Voltage Regulator-Down (VRD) 10.1 Design Guide For Desktop and Transportable LGA775 Socket* for socket loadline guidelines and VR implementation details.

2.5.3 V_{CC} Overshoot

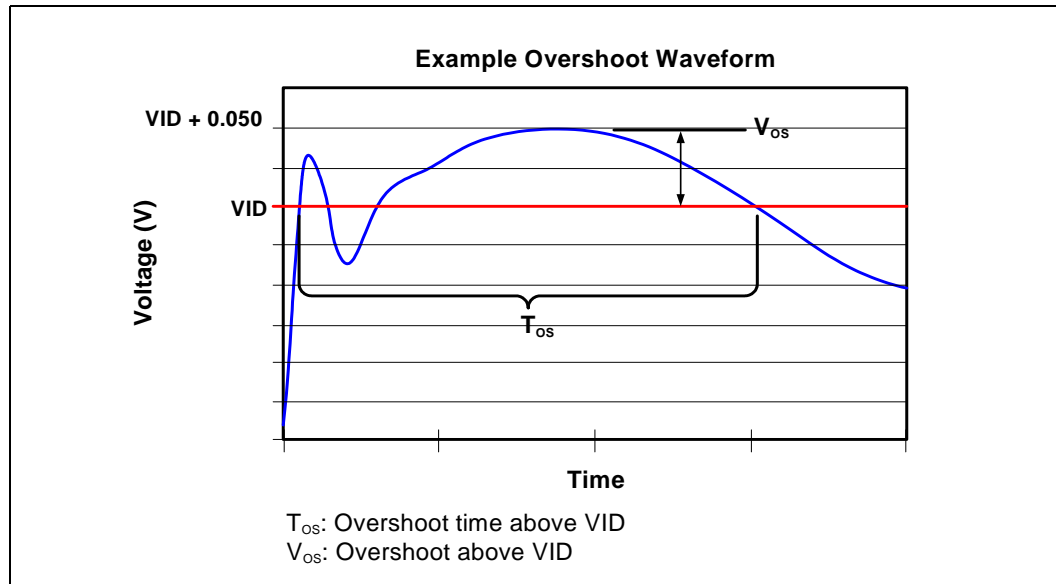
The processor can tolerate short transient overshoot events where V_{CC} exceeds the VID voltage when transitioning from a high to low current load condition. This overshoot cannot exceed VID + V_{OS_MAX} (V_{OS_MAX} is the maximum allowable overshoot voltage). The time duration of the overshoot event must not exceed T_{OS_MAX} (T_{OS_MAX} is the maximum allowable time duration above VID). These specifications apply to the processor die voltage as measured across the VCC_SENSE and VSS_SENSE lands.

Table 6. V_{CC} Overshoot Specifications

Symbol	Parameter	Min	Max	Unit	Figure	Notes
V _{OS_MAX}	Magnitude of V _{CC} overshoot above VID	—	0.050	V	2	1
T _{OS_MAX}	Time duration of V _{CC} overshoot above VID	—	25	μs	2	1

NOTES:

1. Adherence to these specifications for the Pentium 4 processor is required to ensure reliable processor operation.

Figure 2. V_{CC} Overshoot Example Waveform

NOTES:

1. V_{OS} is measured overshoot voltage.
2. T_{OS} is measured time duration above VID.

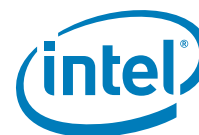
2.5.4 Die Voltage Validation

Overshoot events on the processor must meet the specifications in [Table 6](#) when measured across the V_{CC_SENSE} and V_{SS_SENSE} lands. Overshoot events that are < 10 ns in duration may be ignored. These measurements of processor die level overshoot must be taken with a bandwidth limited oscilloscope set to a greater than or equal to 100 MHz bandwidth limit.

2.6 Signaling Specifications

Most processor front side bus signals use Gunning Transceiver Logic (GTL+) signaling technology. This technology provides improved noise margins and reduced ringing through low voltage swings and controlled edge rates. Platforms implement a termination voltage level for GTL+ signals defined as V_{TT} . Because platforms implement separate power planes for each processor (and chipset), separate V_{CC} and V_{TT} supplies are necessary. This configuration allows for improved noise tolerance as processor frequency increases. Speed enhancements to data and address busses have caused signal integrity considerations and platform design methods to become even more critical than with previous processor families.

The GTL+ inputs require a reference voltage (GTLREF) that is used by the receivers to determine if a signal is a logical 0 or a logical 1. GTLREF must be generated on the motherboard (see [Table 16](#) for GTLREF specifications). Termination resistors (R_{TT}) for GTL+ signals are provided on the processor silicon and are terminated to V_{TT} . Intel chipsets will also provide on-die termination, thus eliminating the need to terminate the bus on the motherboard for most GTL+ signals.



2.6.1 FSB Signal Groups

The front side bus signals have been combined into groups by buffer type. GTL+ input signals have differential input buffers that use GTLREF[1:0] as a reference level. In this document, the term “GTL+ Input” refers to the GTL+ input group as well as the GTL+ I/O group when receiving. Similarly, “GTL+ Output” refers to the GTL+ output group as well as the GTL+ I/O group when driving.

With the implementation of a source synchronous data bus comes the need to specify two sets of timing parameters. One set is for common clock signals that are dependent on the rising edge of BCLK0 (ADS#, HIT#, HITM#, etc.) and the second set is for the source synchronous signals that are relative to their respective strobe lines (data and address) as well as the rising edge of BCLK0. Asynchronous signals are still present (A20M#, IGNNE#, etc.) and can become active at any time during the clock cycle. Table 7 identifies which signals are common clock, source synchronous, and asynchronous.

Table 7. FSB Signal Groups (Sheet 1 of 2)

Signal Group	Type	Signals ¹														
GTL+ Common Clock Input	Synchronous to BCLK[1:0]	BPRI#, DEFER#, RESET#, RS[2:0]#, RSP#, TRDY#														
GTL+ Common Clock I/O	Synchronous to BCLK[1:0]	AP[1:0]#, ADS#, BINIT#, BNR#, BPM[5:0]#, BRO#, DBSY#, DP[3:0]#, DRDY#, HIT#, HITM#, LOCK#, MCERR#														
GTL+ Source Synchronous I/O	Synchronous to assoc. strobe	<table border="1"> <thead> <tr> <th>Signals</th> <th>Associated Strobe</th> </tr> </thead> <tbody> <tr> <td>REQ[4:0]#, A[16:3]#³</td> <td>ADSTB0#</td> </tr> <tr> <td>A[35:17]#³</td> <td>ADSTB1#</td> </tr> <tr> <td>D[15:0]#, DBI0#</td> <td>DSTBP0#, DSTBN0#</td> </tr> <tr> <td>D[31:16]#, DBI1#</td> <td>DSTBP1#, DSTBN1#</td> </tr> <tr> <td>D[47:32]#, DBI2#</td> <td>DSTBP2#, DSTBN2#</td> </tr> <tr> <td>D[63:48]#, DBI3#</td> <td>DSTBP3#, DSTBN3#</td> </tr> </tbody> </table>	Signals	Associated Strobe	REQ[4:0]#, A[16:3]# ³	ADSTB0#	A[35:17]# ³	ADSTB1#	D[15:0]#, DBI0#	DSTBP0#, DSTBN0#	D[31:16]#, DBI1#	DSTBP1#, DSTBN1#	D[47:32]#, DBI2#	DSTBP2#, DSTBN2#	D[63:48]#, DBI3#	DSTBP3#, DSTBN3#
		Signals	Associated Strobe													
		REQ[4:0]#, A[16:3]# ³	ADSTB0#													
		A[35:17]# ³	ADSTB1#													
		D[15:0]#, DBI0#	DSTBP0#, DSTBN0#													
		D[31:16]#, DBI1#	DSTBP1#, DSTBN1#													
		D[47:32]#, DBI2#	DSTBP2#, DSTBN2#													
D[63:48]#, DBI3#	DSTBP3#, DSTBN3#															
GTL+ Strobes	Synchronous to BCLK[1:0]	ADSTB[1:0]#, DSTBP[3:0]#, DSTBN[3:0]#														
GTL+ Asynchronous Input		A20M#, IGNNE#, INIT#, LINT0/INTR, LINT1/NMI, SMI#, STPCLK#, PWRGOOD														
GTL+ Asynchronous Output		FERR#/PBE#, IERR#, THERMTRIP#														
GTL+ Asynchronous Input/Output		PROCHOT#														
TAP Input	Synchronous to TCK	TCK, TDI, TMS, TRST#														

Table 7. FSB Signal Groups (Sheet 2 of 2)

Signal Group	Type	Signals ¹
TAP Output	Synchronous to TCK	TDO
FSB Clock	Clock	BCLK[1:0], ITP_CLK[1:0] ²
Power/Other		VCC, VTT, VCCA, VCCIOPLL, VID[5:0], VSS, VSSA, GTLREF[1:0], COMP[5:4,1:0], RESERVED, TESTHI[13:0], THERMDA, THERMDC, VCC_SENSE, VCC_MB_REGULATION, VSS_SENSE, VSS_MB_REGULATION, BSEL[2:0], SKTOCC#, DBR# ² , VTPWRGD, BOOTSELECT, VTT_OUT_LEFT, VTT_OUT_RIGHT, VTT_SEL, LL_ID[1:0], MSID[1:0], FCx, IMPSEL

NOTES:

1. Refer to [Section 4.2](#) for signal descriptions.
2. In processor systems where no debug port is implemented on the system board, these signals are used to support a debug port interposer. In systems with the debug port implemented on the system board, these signals are no connects.
3. The value of these signals during the active-to-inactive edge of RESET# defines the processor configuration options. See [Section 6.1](#) for details.

Table 8. Signal Characteristics

Signals with R _{TT}	Signals with No R _{TT}
A[35:3]#, ADS#, ADSTB[1:0]#, AP[1:0]#, BINIT#, BNR#, BOOTSELECT ¹ , BPRI#, D[63:0]#, DBI[3:0]#, DBSY#, DEFER#, DP[3:0]#, DRDY#, DSTBN[3:0]#, DSTBP[3:0]#, HIT#, HITM#, LOCK#, MCERR#, MSID[1:0] ¹ , PROCHOT#, REQ[4:0]#, RS[2:0]#, RSP#, TRDY#, IMPSEL ¹	A20M#, BCLK[1:0], BPM[5:0]#, BSEL[2:0], COMP[5:4,1:0], FERR#/PBE#, IERR#, IGNNE#, INIT#, ITP_CLK[1:0], LINT0/INTR, LINT1/NMI, PWRGOOD, RESET#, SKTOCC#, SMI#, STPCLK#, TDO, TESTHI[13:0], THERMDA, THERMDC, THERMTRIP#, VID[5:0], VTPWRGD, GTLREF[1:0], TCK, TDI, TMS, TRST#, VTT_SEL
Open Drain Signals²	
THERMTRIP#, FERR#/PBE#, IERR#, BPM[5:0]#, BRO#, TDO, LL_ID[1:0], FCx	

NOTES:

1. These signals have a 500–5000 Ω pull-up to V_{TT} rather than on-die termination.
2. Signals that do not have R_{TT}, nor are actively driven to their high-voltage level.

Table 9. Signal Reference Voltages

GTLREF	V _{TT} /2
BPM[5:0]#, LINT0/INTR, LINT1/NMI, RESET#, BINIT#, BNR#, HIT#, HITM#, MCERR#, PROCHOT#, BRO#, A[35:0]#, ADS#, ADSTB[1:0]#, AP[1:0]#, BPRI#, D[63:0]#, DBI[3:0]#, DBSY#, DEFER#, DP[3:0]#, DRDY#, DSTBN[3:0]#, DSTBP[3:0]#, LOCK#, REQ[4:0]#, RS[2:0]#, RSP#, TRDY#	BOOTSELECT, VTPWRGD, A20M#, IGNNE#, INIT#, MSID[1:0], PWRGOOD ¹ , SMI#, STPCLK#, TCK ¹ , TDI ¹ , TMS ¹ , TRST# ¹

NOTES:

1. These signals also have hysteresis added to the reference voltage. See [Table 12](#) for more information.



2.6.2 GTL+ Asynchronous Signals

Legacy input signals such as A20M#, IGNNE#, INIT#, SMI#, and STPCLK# use CMOS input buffers. All of these signals follow the same DC requirements as GTL+ signals; however, the outputs are not actively driven high (during a logical 0-to-1 transition) by the processor. These signals do not have setup or hold time specifications in relation to BCLK[1:0].

All of the GTL+ Asynchronous signals are required to be asserted/deasserted for at least six BCLKs in order for the processor to recognize the proper signal state. See [Section 2.6.3](#) for the DC specifications for the GTL+ Asynchronous signal groups. See [Section 6.2](#) for additional timing requirements for entering and leaving the low power states.

2.6.3 Processor DC Specifications

The processor DC specifications in this section are defined at the processor core (pads) unless otherwise stated. All specifications apply to all frequencies and cache sizes unless otherwise stated.

Table 10. GTL+ Signal Group DC Specifications

Symbol	Parameter	Min	Max	Unit	Notes ¹
V _{IL}	Input Low Voltage	0.0	GTLREF – (0.10 * V _{TT})	V	2, 3
V _{IH}	Input High Voltage	GTLREF + (0.10 * V _{TT})	V _{TT}	V	3, 4, 5
V _{OH}	Output High Voltage	0.90*V _{TT}	V _{TT}	V	5, 6
I _{OL}	Output Low Current	N/A	$\frac{V_{TT_MAX}}{[(0.50 * R_{TT_MIN}) + (R_{ON_MIN})]}$	A	
I _{LI}	Input Leakage Current	N/A	± 200	µA	6
I _{LO}	Output Leakage Current	N/A	± 200	µA	7
R _{ON}	Buffer On Resistance	6	12	W	

NOTES:

- Unless otherwise noted, all specifications in this table apply to all processor frequencies.
- V_{IL} is defined as the voltage range at a receiving agent that will be interpreted as a logical low value.
- The V_{TT} referred to in these specifications is the instantaneous V_{TT}.
- V_{IH} is defined as the voltage range at a receiving agent that will be interpreted as a logical high value.
- V_{IH} and V_{OH} may experience excursions above V_{TT}. However, input signal drivers must comply with the signal quality specifications.
- Leakage to V_{SS} with land held at V_{TT}.
- Leakage to V_{TT} with land held at 300 mV.

Table 11. GTL+ Asynchronous Signal Group DC Specifications

Symbol	Parameter	Min	Max	Unit	Notes ¹
V _{IL}	Input Low Voltage	0.0	V _{TT} /2 – (0.10 * V _{TT})	V	2, 3
V _{IH}	Input High Voltage	V _{TT} /2 + (0.10 * V _{TT})	V _{TT}	V	3, 4, 5, 6
V _{OH}	Output High Voltage	0.90*V _{TT}	V _{TT}	V	5, 6, 7
I _{OL}	Output Low Current	—	$\frac{V_{TT}}{[(0.50 * R_{TT_MIN}) + (R_{ON_MIN})]}$	A	8



Table 11. GTL+ Asynchronous Signal Group DC Specifications

Symbol	Parameter	Min	Max	Unit	Notes ¹
I _{LI}	Input Leakage Current	N/A	± 200	µA	9
I _{LO}	Output Leakage Current	N/A	± 200	µA	10
R _{ON}	Buffer On Resistance	6	12	W	

NOTES:

1. Unless otherwise noted, all specifications in this table apply to all processor frequencies.
2. V_{IL} is defined as the voltage range at a receiving agent that will be interpreted as a logical low value.
3. LINT0/INTR and LINT1/NMI use GTLREF as a reference voltage. For these two signals, V_{IH} = GTLREF + (0.10 * V_{TT}) and V_{IL} = GTLREF - (0.10 * V_{TT}).
4. V_{IH} is defined as the voltage range at a receiving agent that will be interpreted as a logical high value.
5. V_{IH} and V_{OH} may experience excursions above V_{TT}. However, input signal drivers must comply with the signal quality specifications.
6. The V_{TT} referred to in these specifications refers to instantaneous V_{TT}.
7. All outputs are open drain.
8. The maximum output current is based on maximum current handling capability of the buffer and is not specified into the test load.
9. Leakage to V_{SS} with land held at V_{TT}.
10. Leakage to V_{TT} with land held at 300 mV.

Table 12. PWRGOOD and TAP Signal Group DC Specifications

Symbol	Parameter	Min	Max	Unit	Notes ^{1, 2}
V _{HYS}	Input Hysteresis	120	396	mV	3
V _{T+}	PWRGOOD Input low-to-high threshold voltage	0.5 * (V _{TT} + V _{HYS_MIN} + 0.24)	0.5 * (V _{TT} + V _{HYS_MAX} + 0.24)	V	4, 5
	TAP Input low-to-high threshold voltage	0.5 * (V _{TT} + V _{HYS_MIN})	0.5 * (V _{TT} + V _{HYS_MAX})	V	4
V _{T-}	PWRGOOD Input high-to-low threshold voltage	0.4 * V _{TT}	0.6 * V _{TT}	V	4
	TAP Input high-to-low threshold voltage	0.5 * (V _{TT} - V _{HYS_MAX})	0.5 * (V _{TT} - V _{HYS_MIN})	V	4
V _{OH}	Output High Voltage	N/A	V _{TT}	V	4, 6
I _{OL}	Output Low Current	—	22.2	mA	7
I _{LI}	Input Leakage Current	—	± 200	µA	8
I _{LO}	Output Leakage Current	—	± 200	µA	9
R _{ON}	Buffer On Resistance	6	12	W	

NOTES:

1. Unless otherwise noted, all specifications in this table apply to all processor frequencies.
2. All outputs are open drain.
3. V_{HYS} represents the amount of hysteresis, nominally centered about 0.5 * V_{TT}, for all TAP inputs.
4. The V_{TT} referred to in these specifications refers to instantaneous V_{TT}.
5. 0.24 V is defined at 20% of nominal V_{TT} of 1.2 V.
6. The TAP signal group must meet the signal quality specifications.
7. The maximum output current is based on maximum current handling capability of the buffer and is not specified into the test load.
8. Leakage to V_{SS} with land held at V_{TT}.
9. Leakage to V_{TT} with land held at 300 mV.

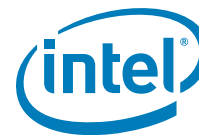


Table 13. VTTTPWRGD DC Specifications

Symbol	Parameter	Min	Typ	Max	Unit
V_{IL}	Input Low Voltage	—	—	0.3	V
V_{IH}	Input High Voltage	0.9	—	—	V

Table 14. BSEL[2:0] and VID[5:0] DC Specifications

Symbol	Parameter	Max	Unit	Notes ^{1, 2}
R_{ON} (BSEL)	Buffer On Resistance	120	Ω	
R_{ON} (VID)	Buffer On Resistance	120	Ω	
I_{OL}	Max Land Current	2.4	mA	
I_{LO}	Output Leakage Current	200	μ A	³
V_{TOL}	Voltage Tolerance	$V_{TT}(\text{max})$	V	

NOTES:

1. Unless otherwise noted, all specifications in this table apply to all processor frequencies.
2. These parameters are not tested and are based on design simulations.
3. Leakage to V_{SS} with land held at 2.5 V.

Table 15. BOOTSELECT DC Specifications

Symbol	Parameter	Min	Typ	Max	Unit	Notes
V_{IL}	Input Low Voltage	—	—	0.24	V	¹
V_{IH}	Input High Voltage	0.96	—	—	V	¹

NOTES:

1. These parameters are not tested and are based on design simulations.



2.6.3.1 GTL+ Front Side Bus Specifications

In most cases, termination resistors are not required as these are integrated into the processor silicon. See [Table 8](#) for details on which GTL+ signals do not include on-die termination.

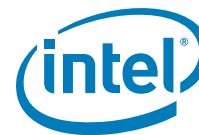
Valid high and low levels are determined by the input buffers by comparing with a reference voltage called GTLREF. [Table 16](#) lists the GTLREF specifications. The GTL+ reference voltage (GTLREF) should be generated on the system board using high precision voltage divider circuits.

Table 16. GTL+ Bus Voltage Definitions

Symbol	Parameter	Min	Typ	Max	Units	Notes ¹
GTLREF_PU	GTLREF pull up resistor	124 * 0.99	124	124 * 1.01	Ω	2
GTLREF_PD	GTLREF pull down resistor	210 * 0.99	210	210 * 1.01	Ω	2
R _{PULLUP}	On die pull-up for BOOTSELECT signal	500	—	5000	Ω	3
R _{TT}	60 Ω Platform Termination Resistance	51	60	66	Ω	4
	50 Ω Platform Termination Resistance	39	50	55	Ω	4
COMP[1:0]	60 Ω Platform Termination COMP Resistance	59.8	60.4	61	Ω	5
	50 Ω Platform Termination COMP Resistance	49.9 * 0.99	49.9	49.9 * 1.01	Ω	5
COMP[5:4]	60 Ω Platform Termination COMP Resistance	59.8	60.4	61	Ω	5
	50 Ω Platform Termination COMP Resistance	49.9 * 0.99	49.9	49.9 * 1.01	Ω	5

NOTES:

1. Unless otherwise noted, all specifications in this table apply to all processor frequencies.
2. GTLREF is to be generated from V_{TT} by a voltage divider of 1% resistors (one divider for each GTLREF land).
3. These pull-ups are to V_{TT}.
4. R_{TT} is the on-die termination resistance measured at V_{TT}/2 of the GTL+ output driver. The IMPSEL pin is used to select a 50 Ω or 60 Ω buffer and R_{TT} value.
5. COMP resistance must be provided on the system board with 1% resistors. COMP[1:0] resistors are to V_{SS}. COMP[5:4] resistors are to V_{TT}.



2.7 Clock Specifications

2.7.1 Front Side Bus Clock (BCLK[1:0]) and Processor Clocking

BCLK[1:0] directly controls the FSB interface speed as well as the core frequency of the processor. As in previous generation processors, the Pentium 4 processor core frequency is a multiple of the BCLK[1:0] frequency. The processor bus ratio multiplier will be set at its default ratio during manufacturing. Refer to Table 17 for the processor supported ratios.

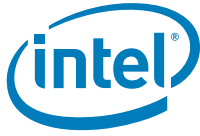
The processor uses a differential clocking implementation. For more information on processor clocking, contact your Intel representative.

Table 17. Core Frequency to FSB Multiplier Configuration

Multiplication of System Core Frequency to FSB Frequency	Core Frequency (200 MHz BCLK/ 800 MHz FSB)	Notes ^{1,2}
1/12	2.40 GHz	
1/13	2.60 GHz	
1/14	2.80 GHz	
1/15	3 GHz	
1/16	3.20 GHz	
1/17	3.40 GHz	
1/18	3.60 GHz	
1/19	3.80 GHz	
1/20	4 GHz	
1/21	4.20 GHz	
1/22	4.40 GHz	
1/23	4.60 GHz	
1/24	4.80 GHz	
1/25	5 GHz	

NOTES:

- Individual processors operate only at or below the rated frequency.
- Listed frequencies are not necessarily committed production frequencies.



2.7.2 FSB Frequency Select Signals (BSEL[2:0])

The BSEL[2:0] signals are used to select the frequency of the processor input clock (BCLK[1:0]). Table 18 defines the possible combinations of the signals and the frequency associated with each combination. The required frequency is determined by the processor, chipset, and clock synthesizer. All agents must operate at the same frequency.

The Pentium 4 processor will operate at an 800 MHz FSB frequency (selected by a 200 MHz BCLK[1:0] frequency).

For more information about these signals, refer to Section 4.2.

Table 18. BSEL[2:0] Frequency Table for BCLK[1:0]

BSEL2	BSEL1	BSEL0	FSB Frequency
L	L	L	RESERVED
L	L	H	RESERVED
L	H	H	RESERVED
L	H	L	200 MHz
H	H	L	RESERVED
H	H	H	RESERVED
H	L	H	RESERVED
H	L	L	RESERVED

2.7.3 Phase Lock Loop (PLL) and Filter

V_{CCA} and $V_{CCIOPLL}$ are power sources required by the PLL clock generators for the Pentium 4 processor silicon. Since these PLLs are analog, they require low noise power supplies for minimum jitter. Jitter is detrimental to the system: it degrades external I/O timings as well as internal core timings (i.e., maximum frequency). To prevent this degradation, these supplies must be low pass filtered from V_{TT} .

The AC low-pass requirements, with input at V_{TT} are as follows:

- < 0.2 dB gain in pass band
- < 0.5 dB attenuation in pass band < 1 Hz
- > 34 dB attenuation from 1 MHz to 66 MHz
- > 28 dB attenuation from 66 MHz to core frequency

The filter requirements are illustrated in Figure 3.

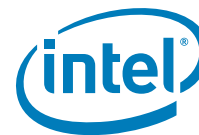
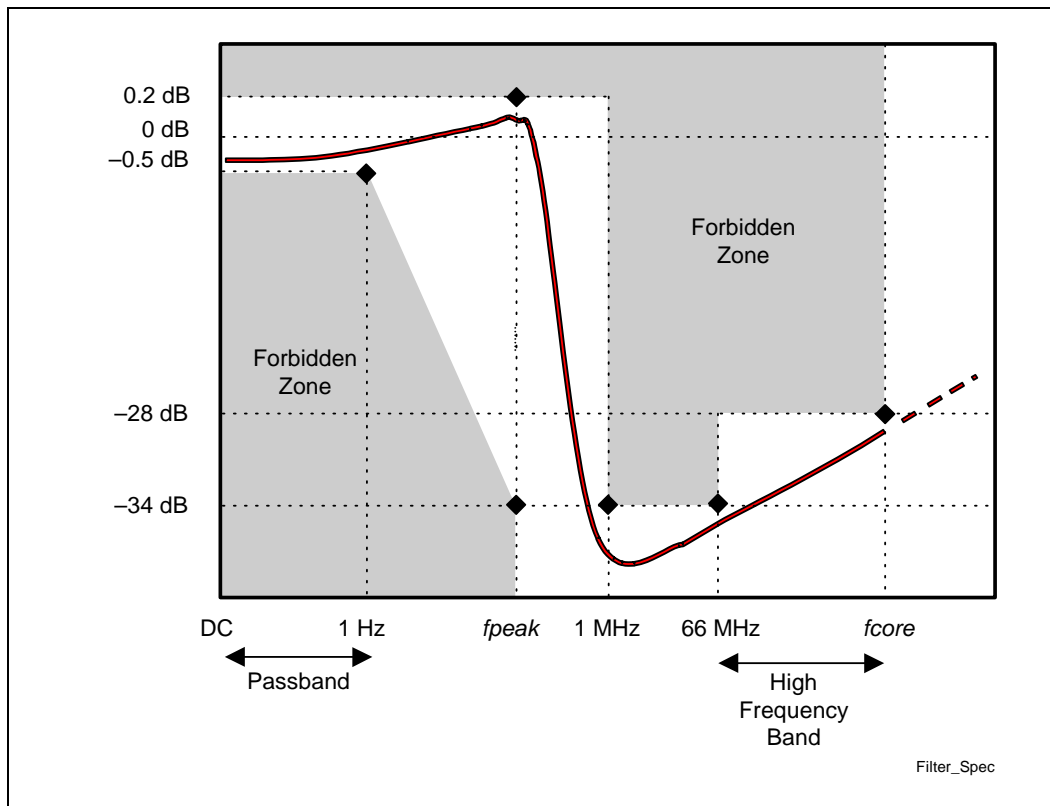
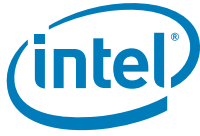


Figure 3. Phase Lock Loop (PLL) Filter Requirements



NOTES:

1. Diagram not to scale.
2. No specification for frequencies beyond f_{core} (core frequency).
3. f_{peak} , if existent, should be less than 0.05 MHz.
4. f_{core} represents the maximum core frequency supported by the platform.



2.7.4 BCLK[1:0] Specifications

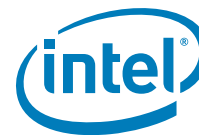
Table 19. Front Side Bus Differential BCLK Specifications

Symbol	Parameter	Min	Typ	Max	Unit	Notes ¹
V_L	Input Low Voltage	-0.150	0.000	N/A	V	
V_H	Input High Voltage	0.660	0.700	0.850	V	
$V_{CROSS(abs)}$	Absolute Crossing Point	0.250	N/A	0.550	V	2, 3
$V_{CROSS(rel)}$	Relative Crossing Point	$0.250 + 0.5(V_{Havg} - 0.700)$	N/A	$0.550 + 0.5(V_{Havg} - 0.700)$	V	3, 4, 5
ΔV_{CROSS}	Range of Crossing Points	N/A	N/A	0.140	V	
V_{OS}	Overshoot	N/A	N/A	$V_H + 0.3$	V	6
V_{US}	Undershoot	-0.300	N/A	N/A	V	7
V_{RBM}	Ringback Margin	0.200	N/A	N/A	V	8
V_{TM}	Threshold Region	$V_{CROSS} - 0.100$	N/A	$V_{CROSS} + 0.100$	V	9

NOTES:

1. Unless otherwise noted, all specifications in this table apply to all processor frequencies.
2. Crossing voltage is defined as the instantaneous voltage value when the rising edge of BCLK0 equals the falling edge of BCLK1.
3. The crossing point must meet the absolute and relative crossing point specifications simultaneously.
4. V_{Havg} is the statistical average of the V_H measured by the oscilloscope.
5. V_{Havg} can be measured directly using "Vtop" on Agilent* oscilloscopes and "High" on Tektronix* oscilloscopes.
6. Overshoot is defined as the absolute value of the maximum voltage.
7. Undershoot is defined as the absolute value of the minimum voltage.
8. Ringback Margin is defined as the absolute voltage difference between the maximum Rising Edge Ringback and the maximum Falling Edge Ringback.
9. Threshold Region is defined as a region entered around the crossing point voltage in which the differential receiver switches. It includes input threshold hysteresis.





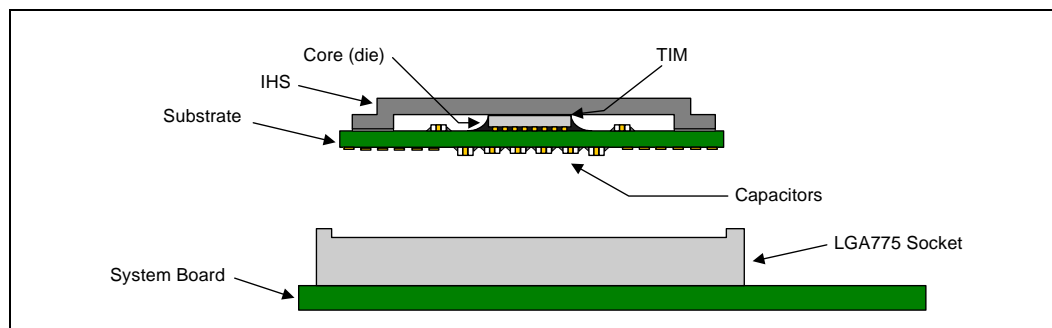
3 Package Mechanical Specifications

The Pentium 4 processor is packaged in a Flip-Chip Land Grid Array (FC-LGA6) package that interfaces with the motherboard via an LGA775 socket. The package consists of a processor core mounted on a substrate land-carrier. An integrated heat spreader (IHS) is attached to the package substrate and core and serves as the mating surface for processor component thermal solutions, such as a heatsink. Figure 4 shows a sketch of the processor package components and how they are assembled together. Refer to the *LGA775 Socket Mechanical Design Guide* for complete details on the LGA775 socket.

The package components shown in Figure 4 include the following:

- Integrated Heat Spreader (IHS)
- Thermal Interface Material (TIM)
- Processor core (die)
- Package substrate
- Capacitors

Figure 4. Processor Package Assembly Sketch



NOTE:

1. Socket and motherboard are included for reference and are not part of processor package.

3.1 Package Mechanical Drawing

The package mechanical drawings are shown in Figure 5 and Figure 6. The drawings include dimensions necessary to design a thermal solution for the processor. These dimensions include:

- Package reference with tolerances (total height, length, width, etc.)
- IHS parallelism and tilt
- Land dimensions
- Top-side and back-side component keep-out dimensions
- Reference datums
- All drawing dimensions are in mm [in].
- Guidelines on potential IHS flatness variation with socket load plate actuation and installation of the cooling solution is available in the processor Thermal and Mechanical Design Guidelines (see Section 1.2).

Figure 5. Processor Package Drawing Sheet 1 of 3

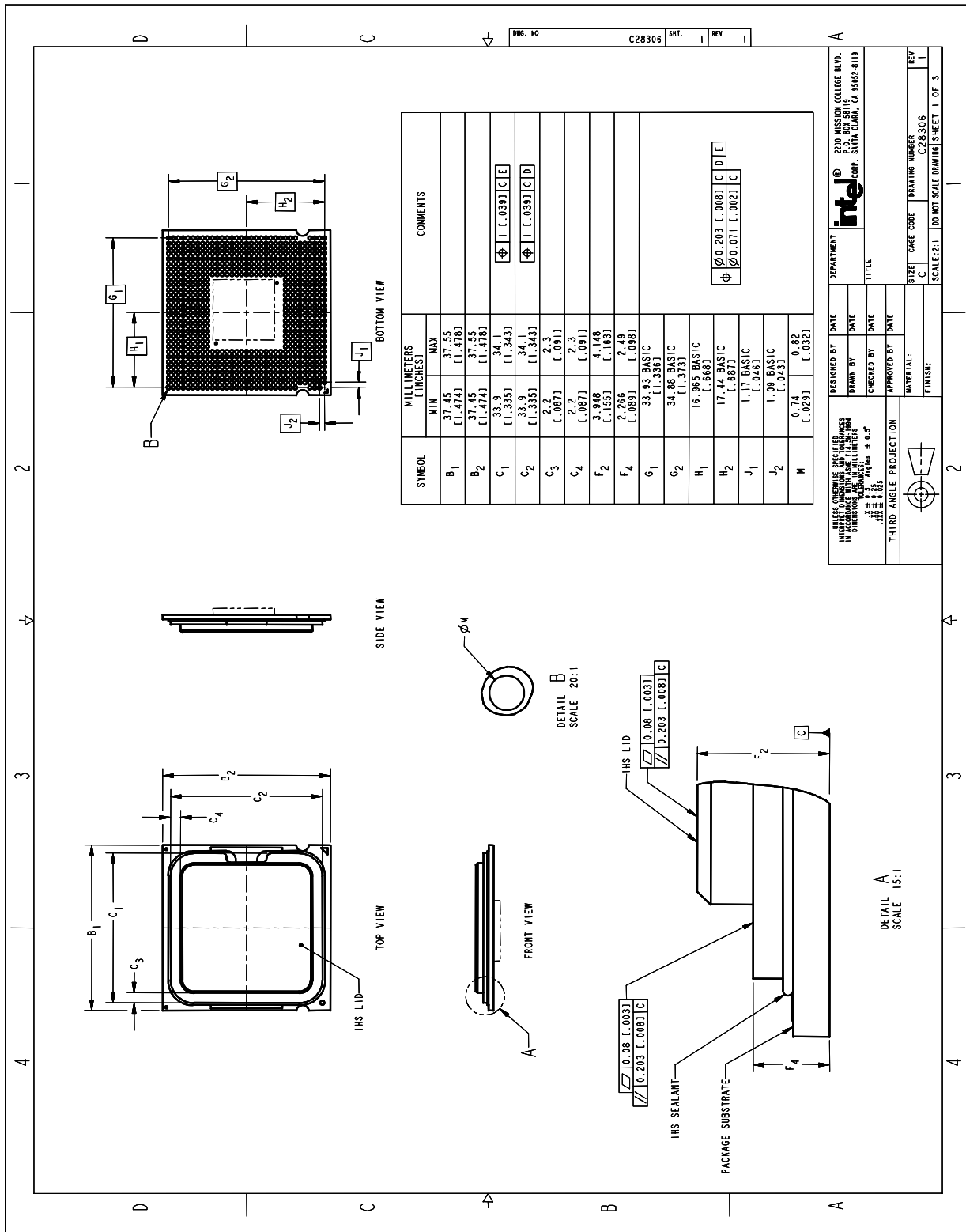




Figure 6. Processor Package Drawing Sheet 2 of 3

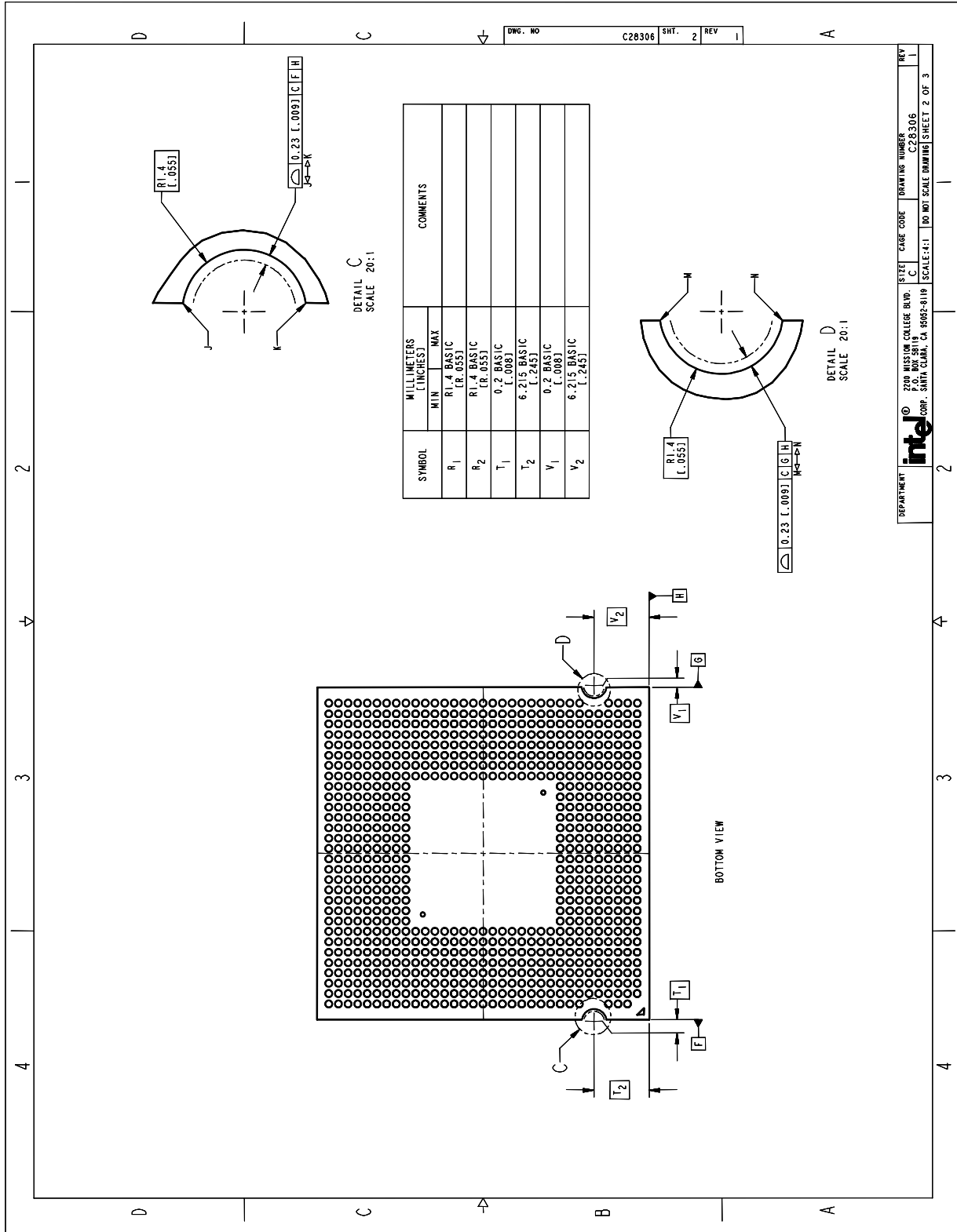
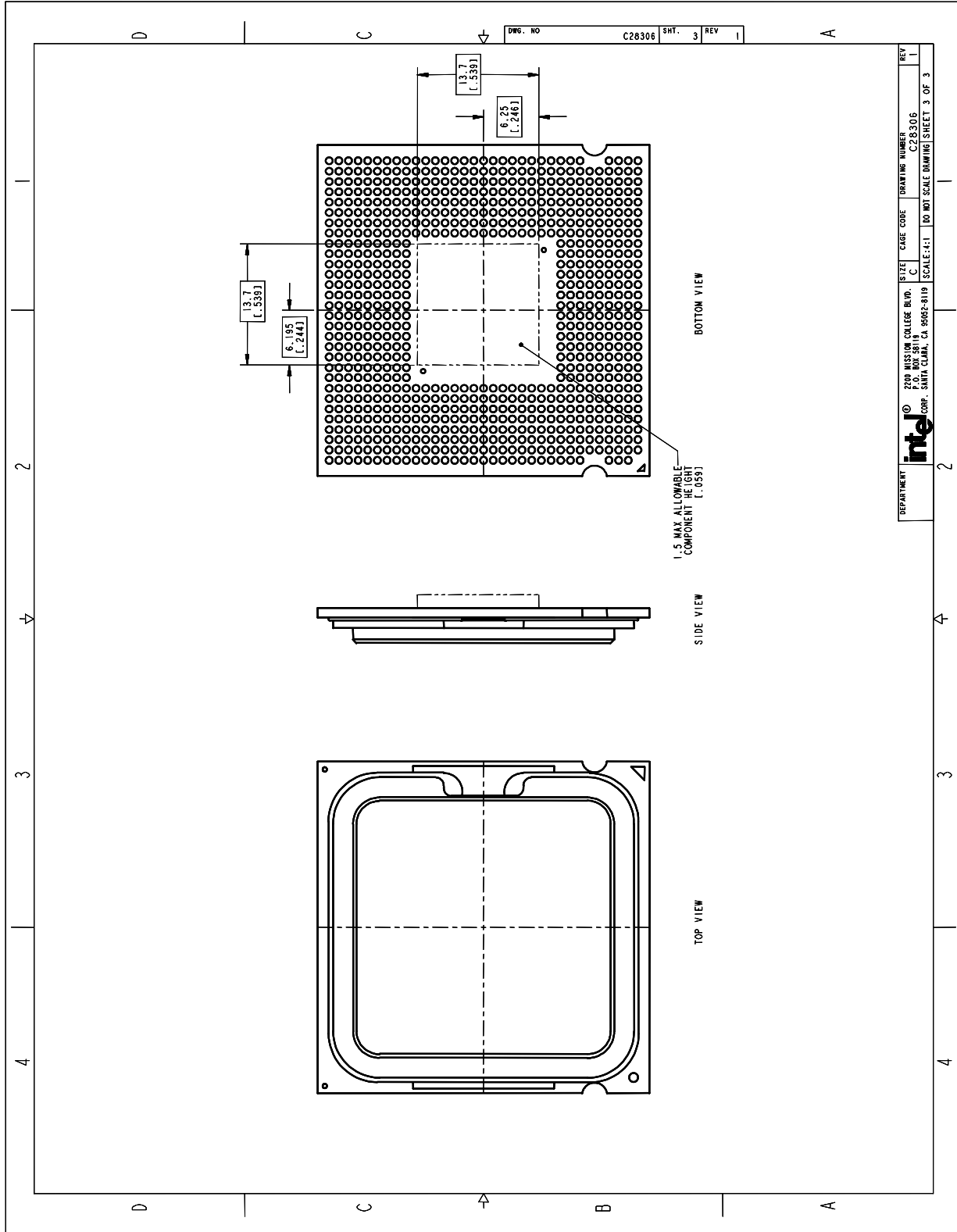


Figure 7. Processor Package Drawing Sheet 3 of 3





3.2 Processor Component Keep-Out Zones

The processor may contain components on the substrate that define component keep-out zone requirements. A thermal and mechanical solution design must not intrude into the required keep-out zones. Decoupling capacitors are typically mounted to either the topside or land-side of the package substrate. See Figure 5 and Figure 6 for keep-out zones. The location and quantity of package capacitors may change due to manufacturing efficiencies but will remain within the component keep-in.

3.3 Package Loading Specifications

Table 20 provides dynamic and static load specifications for the processor package. These mechanical maximum load limits should not be exceeded during heatsink assembly, shipping conditions, or standard use condition. Also, any mechanical system or component testing should not exceed the maximum limits. The processor package substrate should not be used as a mechanical reference or load-bearing surface for thermal and mechanical solution. The minimum loading specification must be maintained by any thermal and mechanical solutions.

Table 20. Processor Loading Specifications

Parameter	Minimum	Maximum	Notes
Static	80 N [17 lbf]	311 N [70 lbf]	1, 2, 3
Dynamic	—	756 N [170 lbf]	1, 3, 4

NOTES:

1. These specifications apply to uniform compressive loading in a direction normal to the processor IHS.
2. This is the maximum force that can be applied by a heatsink retention clip. The clip must also provide the minimum specified load on the processor package.
3. These specifications are based on limited testing for design characterization. Loading limits are for the package only and do not include the limits of the processor socket.
4. Dynamic loading is defined as an 11 ms duration average load superimposed on the static load requirement.

3.4 Package Handling Guidelines

Table 21 includes a list of guidelines on package handling in terms of recommended maximum loading on the processor IHS relative to a fixed substrate. These package handling loads may be experienced during heatsink removal.

Table 21. Package Handling Guidelines

Parameter	Maximum Recommended	Notes
Shear	311 N [70 lbf]	1, 2
Tensile	111 N [25 lbf]	2, 3
Torque	3.95 N-m [35 lbf-in]	2, 4

NOTES:

1. A shear load is defined as a load applied to the IHS in a direction parallel to the IHS top surface.
2. These guidelines are based on limited testing for design characterization.
3. A tensile load is defined as a pulling load applied to the IHS in a direction normal to the IHS surface.
4. A torque load is defined as a twisting load applied to the IHS in an axis of rotation normal to the IHS top surface.

3.5 Package Insertion Specifications

The Pentium 4 processor can be inserted into and removed from a LGA775 socket 15 times. The socket should meet the LGA775 requirements detailed in the *LGA775 Socket Mechanical Design Guide*.

3.6 Processor Mass Specification

The typical mass of the Pentium 4 processor is 21.5 g [0.76 oz]. This mass [weight] includes all the components that are included in the package.

3.7 Processor Materials

Table 22 lists some of the package components and associated materials.

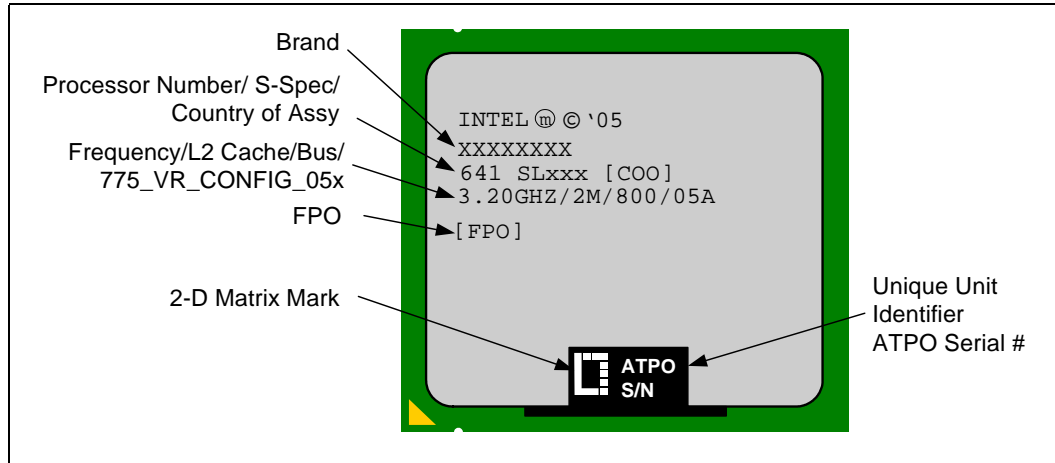
Table 22. Processor Materials

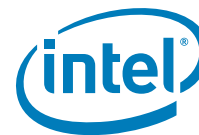
Component	Material
Integrated Heat Spreader (IHS)	Nickel Plated Copper
Substrate	Fiber Reinforced Resin
Substrate Lands	Gold Plated Copper

3.8 Processor Markings

Figure 8 shows the topside markings on the processor. This diagram is to aid in the identification of the Pentium 4 processor.

Figure 8. Processor Top-Side Markings Example

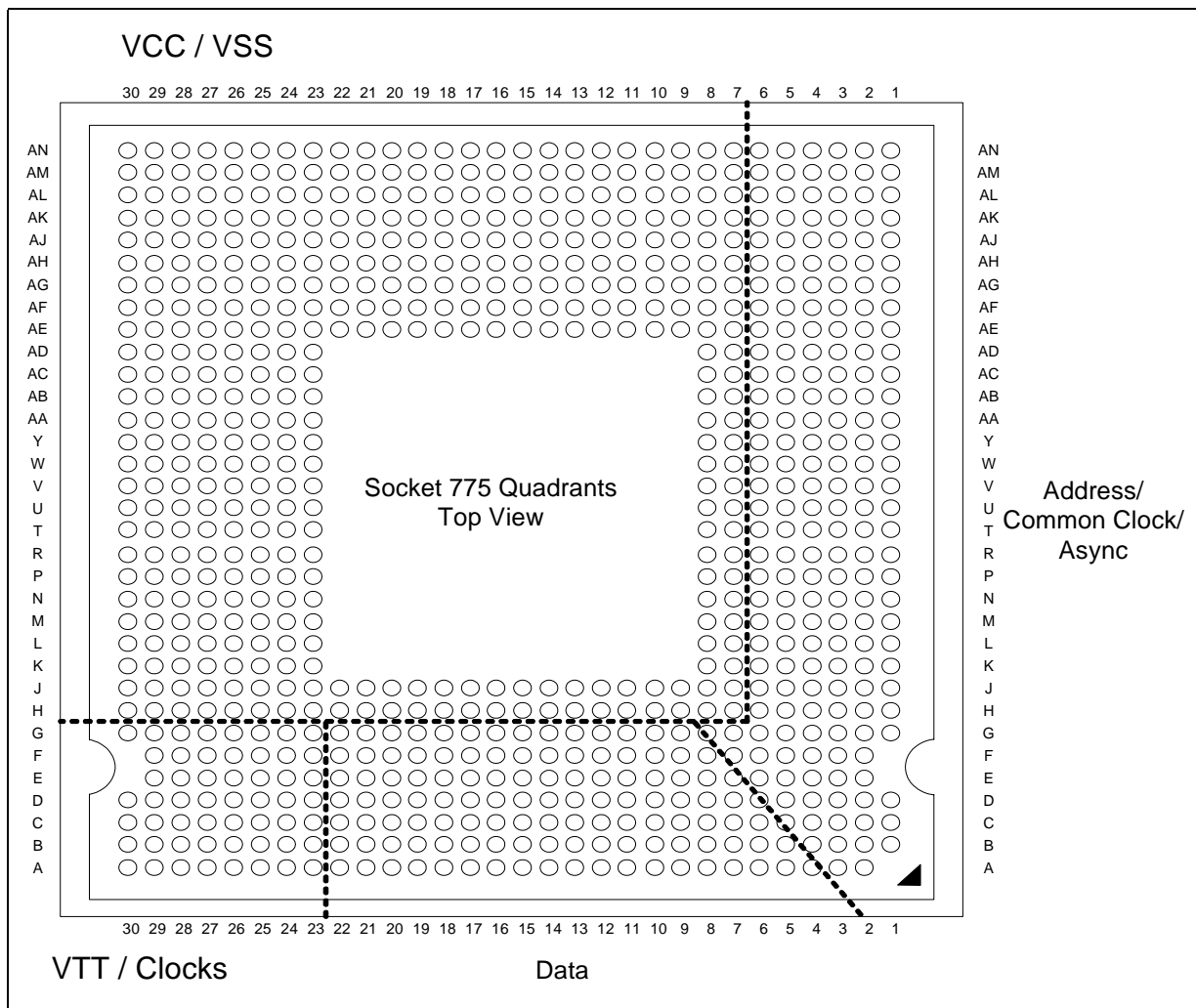




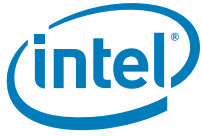
3.9 Processor Land Coordinates

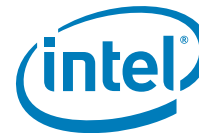
Figure 9 shows the top view of the processor land coordinates. The coordinates are referred to throughout the document to identify processor lands.

Figure 9. Processor Land Coordinates and Quadrants (Top View)



§ §





4 *Land Listing and Signal Descriptions*

This chapter provides the processor land assignment and signal descriptions.

4.1 Processor Land Assignments

This section contains the land listings for the processor. The land-out footprint is shown in [Figure 10](#) and [Figure 11](#). These figures represent the land-out arranged by land number and they show the physical location of each signal on the package land array (top view). [Table 23](#) is a listing of all processor lands ordered alphabetically by land (signal) name. [Table 24](#) is also a listing of all processor lands; the ordering is by land number.



Figure 10. land-out Diagram (Top View – Left Side)

	30	29	28	27	26	25	24	23	22	21	20	19	18	17	16	15		
AN	VCC	VCC	VSS	VSS	VCC	VCC	VSS	VSS	VCC	VCC	VSS	VCC	VCC	VSS	VSS	VCC		
AM	VCC	VCC	VSS	VSS	VCC	VCC	VSS	VSS	VCC	VCC	VSS	VCC	VCC	VSS	VSS	VCC		
AL	VCC	VCC	VSS	VSS	VCC	VCC	VSS	VSS	VCC	VCC	VSS	VCC	VCC	VSS	VSS	VCC		
AK	VSS	VSS	VSS	VSS	VCC	VCC	VSS	VSS	VCC	VCC	VSS	VCC	VCC	VSS	VSS	VCC		
AJ	VSS	VSS	VSS	VSS	VCC	VCC	VSS	VSS	VCC	VCC	VSS	VCC	VCC	VSS	VSS	VCC		
AH	VCC	VCC	VCC	VCC	VCC	VCC	VSS	VSS	VCC	VCC	VSS	VCC	VCC	VSS	VSS	VCC		
AG	VCC	VCC	VCC	VCC	VCC	VCC	VSS	VSS	VCC	VCC	VSS	VCC	VCC	VSS	VSS	VCC		
AF	VSS	VSS	VSS	VSS	VSS	VSS	VSS	VSS	VCC	VCC	VSS	VCC	VCC	VSS	VSS	VCC		
AE	VSS	VSS	VSS	VSS	VSS	VSS	VSS	VCC	VCC	VCC	VSS	VCC	VCC	VSS	VSS	VCC		
AD	VCC	VCC	VCC	VCC	VCC	VCC	VCC	VCC										
AC	VCC	VCC	VCC	VCC	VCC	VCC	VCC	VCC										
AB	VSS	VSS	VSS	VSS	VSS	VSS	VSS	VSS										
AA	VSS	VSS	VSS	VSS	VSS	VSS	VSS	VSS										
Y	VCC	VCC	VCC	VCC	VCC	VCC	VCC	VCC										
W	VCC	VCC	VCC	VCC	VCC	VCC	VCC	VCC										
V	VSS	VSS	VSS	VSS	VSS	VSS	VSS	VSS										
U	VCC	VCC	VCC	VCC	VCC	VCC	VCC	VCC										
T	VCC	VCC	VCC	VCC	VCC	VCC	VCC	VCC										
R	VSS	VSS	VSS	VSS	VSS	VSS	VSS	VSS										
P	VSS	VSS	VSS	VSS	VSS	VSS	VSS	VSS										
N	VCC	VCC	VCC	VCC	VCC	VCC	VCC	VCC										
M	VCC	VCC	VCC	VCC	VCC	VCC	VCC	VCC										
L	VSS	VSS	VSS	VSS	VSS	VSS	VSS	VSS										
K	VCC	VCC	VCC	VCC	VCC	VCC	VCC	VCC										
J	VCC	VCC	VCC	VCC	VCC	VCC	VCC	VCC	VCC	VCC	VCC	VCC	VCC	DP3#	DP0#	VCC		
H	BSEL1	FC15	VSS	VSS	VSS	VSS	VSS	VSS	VSS	VSS	VSS	VSS	VSS	VSS	DP2#	DP1#		
G	BSEL2	BSEL0	BCLK1	TESTH4	TESTH5	TESTH3	TESTH6	RESET#	D47#	D44#	DSTBN2#	DSTBP2#	D35#	D36#	D32#	D31#		
F		RSVD	BCLK0	VTT_SEL	TESTH0	TESTH2	TESTH7	RSVD	VSS	D43#	D41#	VSS	D38#	D37#	VSS	D30#		
E		VSS	VSS	VSS	VSS	VSS	FC10	RSVD	D45#	D42#	VSS	D40#	D39#	VSS	D34#	D33#		
D	VTT	VTT	VTT	VTT	VTT	VTT	VSS	FC9	D46#	VSS	D48#	DBI2#	VSS	D49#	RSVD	VSS		
C	VTT	VTT	VTT	VTT	VTT	VTT	VSS	VCCIO PLL	VSS	D58#	DBI3#	VSS	D54#	DSTBP3#	VSS	D51#		
B	VTT	VTT	VTT	VTT	VTT	VTT	VSS	VSSA	D63#	D59#	VSS	D60#	D57#	VSS	D55#	D53#		
A	VTT	VTT	VTT	VTT	VTT	VTT	VSS	VCCA	D62#	VSS	RSVD	D61#	VSS	D56#	DSTBN3#	VSS		

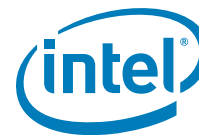


Figure 11.land-out Diagram (Top View – Right Side)

14	13	12	11	10	9	8	7	6	5	4	3	2	1		
VCC	VSS	VCC	VCC	VSS	VCC	VCC	FC16	VSS_MB_REGULATION	VCC_MB_REGULATION	VSS_SENSE	VCC_SENSE	VSS	VSS	AN	
VCC	VSS	VCC	VCC	VSS	VCC	VCC	FC12	VTT_PWRGD	FC11	VSS	VID2	VID0	VSS	AM	
VCC	VSS	VCC	VCC	VSS	VCC	VCC	VSS	VID3	VID1	VID5	VSS	PROCHOT#	THERMDA	AL	
VCC	VSS	VCC	VCC	VSS	VCC	VCC	VSS	FC8	VSS	VID4	ITP_CLK0	VSS	THERMDC	AK	
VCC	VSS	VCC	VCC	VSS	VCC	VCC	VSS	A35#	A34#	VSS	ITP_CLK1	BPM0#	BPM1#	AJ	
VCC	VSS	VCC	VCC	VSS	VCC	VCC	VSS	VSS	A33#	A32#	VSS	RSVD	VSS	AH	
VCC	VSS	VCC	VCC	VSS	VCC	VCC	VSS	A29#	A31#	A30#	BPM5#	BPM3#	TRST#	AG	
VCC	VSS	VCC	VCC	VSS	VCC	VCC	VSS	VSS	A27#	A28#	VSS	BPM4#	TDO	AF	
VCC	VSS	VCC	VCC	VSS	VCC	VCC	SKTOCC#	VSS	RSVD	VSS	RSVD	FC18	VSS	AE	
							VCC	VSS	A22#	ADSTB1#	VSS	BIN1#	BPM2#	TDI	AD
							VCC	VSS	VSS	A25#	RSVD	VSS	DBR#	TMS	AC
							VCC	VSS	A17#	A24#	A26#	MCERR#	IERR#	VSS	AB
							VCC	VSS	VSS	A23#	A21#	VSS	LL_ID1	VTT_OUT_RIGHT	AA
							VCC	VSS	A19#	VSS	A20#	FC17	VSS	BOOT_SELECT	Y
							VCC	VSS	A18#	A16#	VSS	TESTH11	TESTH12	MSID0	W
							VCC	VSS	VSS	A14#	A15#	VSS	LL_ID0	MSID1	V
							VCC	VSS	A10#	A12#	A13#	AP1#	AP0#	VSS	U
							VCC	VSS	VSS	A9#	A11#	VSS	COMP5	COMP1	T
							VCC	VSS	ADSTB0#	VSS	A8#	FERR#/PBE#	VSS	FC2	R
							VCC	VSS	A4#	RSVD	VSS	INIT#	SMI#	TESTH11	P
							VCC	VSS	VSS	RSVD	RSVD	VSS	IGNNE#	PWRGOOD	N
							VCC	VSS	REQ2#	A5#	A7#	STPCLK#	THERMTRIP#	VSS	M
							VCC	VSS	VSS	A3#	A6#	VSS	TESTH13	LINT1	L
							VCC	VSS	REQ3#	VSS	REQ0#	A20M#	VSS	LINT0	K
VCC	VCC	VCC	VCC	VCC	VCC	VCC	VSS	REQ4#	REQ1#	VSS	FC22	COMP4	VTT_OUT_LEFT	J	
VSS	VSS	VSS	VSS	VSS	VSS	VSS	VSS	VSS	TESTH10	RSP#	VSS	GTLREF1	GTLREF0	H	
D29#	D27#	DSTBN1#	DBI1#	RSVD	D16#	BPR1#	DEFER#	RSVD	FC7	TESTH9	TESTH8	FC1	VSS	G	
D28#	VSS	D24#	D23#	VSS	D18#	D17#	VSS	IMPSEL	RS1#	VSS	BR0#	FC5		F	
VSS	D26#	DSTBP1#	VSS	D21#	D19#	VSS	RSVD	RSVD	FC20	HITM#	TRDY#	VSS		E	
RSVD	D25#	VSS	D15#	D22#	VSS	D12#	D20#	VSS	VSS	HIT#	VSS	ADS#	RSVD	D	
D52#	VSS	D14#	D11#	VSS	RSVD	DSTBN0#	VSS	D3#	D1#	VSS	LOCK#	BNR#	DRDY#	C	
VSS	FC19	D13#	VSS	D10#	DSTBP0#	VSS	D6#	D5#	VSS	D0#	RS0#	DBSY#	VSS	B	
D50#	COMP0	VSS	D9#	D8#	VSS	DBI0#	D7#	VSS	D4#	D2#	RS2#	VSS		A	



Table 23. Alphabetical Land Assignments

Land Name	Land #	Signal Buffer Type	Direction
A10#	U6	Source Synch	Input/Output
A11#	T4	Source Synch	Input/Output
A12#	U5	Source Synch	Input/Output
A13#	U4	Source Synch	Input/Output
A14#	V5	Source Synch	Input/Output
A15#	V4	Source Synch	Input/Output
A16#	W5	Source Synch	Input/Output
A17#	AB6	Source Synch	Input/Output
A18#	W6	Source Synch	Input/Output
A19#	Y6	Source Synch	Input/Output
A20#	Y4	Source Synch	Input/Output
A20M#	K3	Asynch GTL+	Input
A21#	AA4	Source Synch	Input/Output
A22#	AD6	Source Synch	Input/Output
A23#	AA5	Source Synch	Input/Output
A24#	AB5	Source Synch	Input/Output
A25#	AC5	Source Synch	Input/Output
A26#	AB4	Source Synch	Input/Output
A27#	AF5	Source Synch	Input/Output
A28#	AF4	Source Synch	Input/Output
A29#	AG6	Source Synch	Input/Output
A3#	L5	Source Synch	Input/Output
A30#	AG4	Source Synch	Input/Output
A31#	AG5	Source Synch	Input/Output
A32#	AH4	Source Synch	Input/Output
A33#	AH5	Source Synch	Input/Output
A34#	AJ5	Source Synch	Input/Output
A35#	AJ6	Source Synch	Input/Output
A4#	P6	Source Synch	Input/Output
A5#	M5	Source Synch	Input/Output
A6#	L4	Source Synch	Input/Output
A7#	M4	Source Synch	Input/Output
A8#	R4	Source Synch	Input/Output
A9#	T5	Source Synch	Input/Output
ADS#	D2	Common Clock	Input/Output
ADSTB0#	R6	Source Synch	Input/Output
ADSTB1#	AD5	Source Synch	Input/Output
AP0#	U2	Common Clock	Input/Output
AP1#	U3	Common Clock	Input/Output

Table 23. Alphabetical Land Assignments

Land Name	Land #	Signal Buffer Type	Direction
BCLK0	F28	Clock	Input
BCLK1	G28	Clock	Input
BINIT#	AD3	Common Clock	Input/Output
BNR#	C2	Common Clock	Input/Output
BOOTSELECT	Y1	Power/Other	Input
BPM0#	AJ2	Common Clock	Input/Output
BPM1#	AJ1	Common Clock	Input/Output
BPM2#	AD2	Common Clock	Input/Output
BPM3#	AG2	Common Clock	Input/Output
BPM4#	AF2	Common Clock	Input/Output
BPM5#	AG3	Common Clock	Input/Output
BPRI#	G8	Common Clock	Input
BR0#	F3	Common Clock	Input/Output
BSEL0	G29	Power/Other	Output
BSEL1	H30	Power/Other	Output
BSEL2	G30	Power/Other	Output
COMP0	A13	Power/Other	Input
COMP1	T1	Power/Other	Input
COMP4	J2	Power/Other	Input
COMP5	T2	Power/Other	Input
D0#	B4	Source Synch	Input/Output
D1#	C5	Source Synch	Input/Output
D10#	B10	Source Synch	Input/Output
D11#	C11	Source Synch	Input/Output
D12#	D8	Source Synch	Input/Output
D13#	B12	Source Synch	Input/Output
D14#	C12	Source Synch	Input/Output
D15#	D11	Source Synch	Input/Output
D16#	G9	Source Synch	Input/Output
D17#	F8	Source Synch	Input/Output
D18#	F9	Source Synch	Input/Output
D19#	E9	Source Synch	Input/Output
D2#	A4	Source Synch	Input/Output
D20#	D7	Source Synch	Input/Output
D21#	E10	Source Synch	Input/Output
D22#	D10	Source Synch	Input/Output
D23#	F11	Source Synch	Input/Output
D24#	F12	Source Synch	Input/Output
D25#	D13	Source Synch	Input/Output



Table 23. Alphabetical Land Assignments

Land Name	Land #	Signal Buffer Type	Direction
D26#	E13	Source Synch	Input/Output
D27#	G13	Source Synch	Input/Output
D28#	F14	Source Synch	Input/Output
D29#	G14	Source Synch	Input/Output
D3#	C6	Source Synch	Input/Output
D30#	F15	Source Synch	Input/Output
D31#	G15	Source Synch	Input/Output
D32#	G16	Source Synch	Input/Output
D33#	E15	Source Synch	Input/Output
D34#	E16	Source Synch	Input/Output
D35#	G18	Source Synch	Input/Output
D36#	G17	Source Synch	Input/Output
D37#	F17	Source Synch	Input/Output
D38#	F18	Source Synch	Input/Output
D39#	E18	Source Synch	Input/Output
D4#	A5	Source Synch	Input/Output
D40#	E19	Source Synch	Input/Output
D41#	F20	Source Synch	Input/Output
D42#	E21	Source Synch	Input/Output
D43#	F21	Source Synch	Input/Output
D44#	G21	Source Synch	Input/Output
D45#	E22	Source Synch	Input/Output
D46#	D22	Source Synch	Input/Output
D47#	G22	Source Synch	Input/Output
D48#	D20	Source Synch	Input/Output
D49#	D17	Source Synch	Input/Output
D5#	B6	Source Synch	Input/Output
D50#	A14	Source Synch	Input/Output
D51#	C15	Source Synch	Input/Output
D52#	C14	Source Synch	Input/Output
D53#	B15	Source Synch	Input/Output
D54#	C18	Source Synch	Input/Output
D55#	B16	Source Synch	Input/Output
D56#	A17	Source Synch	Input/Output
D57#	B18	Source Synch	Input/Output
D58#	C21	Source Synch	Input/Output
D59#	B21	Source Synch	Input/Output
D6#	B7	Source Synch	Input/Output
D60#	B19	Source Synch	Input/Output

Table 23. Alphabetical Land Assignments

Land Name	Land #	Signal Buffer Type	Direction
D61#	A19	Source Synch	Input/Output
D62#	A22	Source Synch	Input/Output
D63#	B22	Source Synch	Input/Output
D7#	A7	Source Synch	Input/Output
D8#	A10	Source Synch	Input/Output
D9#	A11	Source Synch	Input/Output
DBI0#	A8	Source Synch	Input/Output
DBI1#	G11	Source Synch	Input/Output
DBI2#	D19	Source Synch	Input/Output
DBI3#	C20	Source Synch	Input/Output
DBR#	AC2	Power/Other	Output
DBSY#	B2	Common Clock	Input/Output
DEFER#	G7	Common Clock	Input
DP0#	J16	Common Clock	Input/Output
DP1#	H15	Common Clock	Input/Output
DP2#	H16	Common Clock	Input/Output
DP3#	J17	Common Clock	Input/Output
DRDY#	C1	Common Clock	Input/Output
DSTBN0#	C8	Source Synch	Input/Output
DSTBN1#	G12	Source Synch	Input/Output
DSTBN2#	G20	Source Synch	Input/Output
DSTBN3#	A16	Source Synch	Input/Output
DSTBP0#	B9	Source Synch	Input/Output
DSTBP1#	E12	Source Synch	Input/Output
DSTBP2#	G19	Source Synch	Input/Output
DSTBP3#	C17	Source Synch	Input/Output
FC1	G2	Power/Other	Input
FC11	AM5	Power/Other	Output
FC12	AM7	Power/Other	Output
FC15	H29	Power/Other	Output
FC16	AN7	Power/Other	Output
FC2	R1	Power/Other	Input
FC5	F2	Common Clock	Input
FC7	G5	Source Synch	Output
FC8	AK6	Power/Other	Output
FC10	E24	Power/Other	Output
FC17	Y3	Power/Other	Output
FC22	J3	Power/Other	Output
FC19	B13	Power/Other	Output

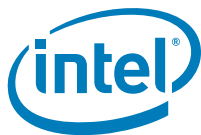


Table 23. Alphabetical Land Assignments

Land Name	Land #	Signal Buffer Type	Direction
FC18	AE3	Power/Other	Output
FC20	E5	Power/Other	Output
FC9	D23	Power/Other	Output
FERR#/PBE#	R3	Asynch GTL+	Output
GTLREF0	H1	Power/Other	Input
GTLREF1	H2	Power/Other	Input
HIT#	D4	Common Clock	Input/Output
HITM#	E4	Common Clock	Input/Output
IERR#	AB2	Asynch GTL+	Output
IGNNE#	N2	Asynch GTL+	Input
IMPSEL	F6	Power/Other	Input
INIT#	P3	Asynch GTL+	Input
ITP_CLK0	AK3	TAP	Input
ITP_CLK1	AJ3	TAP	Input
LINT0	K1	Asynch GTL+	Input
LINT1	L1	Asynch GTL+	Input
LL_ID0	V2	Power/Other	Output
LL_ID1	AA2	Power/Other	Output
LOCK#	C3	Common Clock	Input/Output
MCERR#	AB3	Common Clock	Input/Output
MSID0	W1	Power/Other	Output
MSID1	V1	Power/Other	Output
PROCHOT#	AL2	Asynch GTL+	Input/Output
PWRGOOD	N1	Power/Other	Input
REQ0#	K4	Source Synch	Input/Output
REQ1#	J5	Source Synch	Input/Output
REQ2#	M6	Source Synch	Input/Output
REQ3#	K6	Source Synch	Input/Output
REQ4#	J6	Source Synch	Input/Output
RESERVED	A20		
RESERVED	AC4		
RESERVED	AE4		
RESERVED	AE6		
RESERVED	AH2		
RESERVED	C9		
RESERVED	D1		
RESERVED	D14		
RESERVED	D16		
RESERVED	E23		

Table 23. Alphabetical Land Assignments

Land Name	Land #	Signal Buffer Type	Direction
RESERVED	E6		
RESERVED	E7		
RESERVED	F23		
RESERVED	F29		
RESERVED	G10		
RESERVED	G6		
RESERVED	N4		
RESERVED	N5		
RESERVED	P5		
RESET#	G23	Common Clock	Input
RS0#	B3	Common Clock	Input
RS1#	F5	Common Clock	Input
RS2#	A3	Common Clock	Input
RSP#	H4	Common Clock	Input
SKTOCC#	AE8	Power/Other	Output
SMI#	P2	Asynch GTL+	Input
STPCLK#	M3	Asynch GTL+	Input
TCK	AE1	TAP	Input
TDI	AD1	TAP	Input
TDO	AF1	TAP	Output
TESTHI0	F26	Power/Other	Input
TESTHI1	W3	Power/Other	Input
TESTHI10	H5	Power/Other	Input
TESTHI11	P1	Power/Other	Input
TESTHI12	W2	Power/Other	Input
TESTHI13	L2	Asynch GTL+	Input
TESTHI2	F25	Power/Other	Input
TESTHI3	G25	Power/Other	Input
TESTHI4	G27	Power/Other	Input
TESTHI5	G26	Power/Other	Input
TESTHI6	G24	Power/Other	Input
TESTHI7	F24	Power/Other	Input
TESTHI8	G3	Power/Other	Input
TESTHI9	G4	Power/Other	Input
THERMDA	AL1	Power/Other	
THERMDC	AK1	Power/Other	
THERMTRIP#	M2	Asynch GTL+	Output
TMS	AC1	TAP	Input
TRDY#	E3	Common Clock	Input

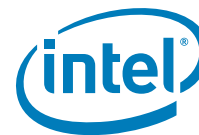


Table 23. Alphabetical Land Assignments

Land Name	Land #	Signal Buffer Type	Direction
TRST#	AG1	TAP	Input
VCC	AA8	Power/Other	
VCC	AB8	Power/Other	
VCC	AC23	Power/Other	
VCC	AC24	Power/Other	
VCC	AC25	Power/Other	
VCC	AC26	Power/Other	
VCC	AC27	Power/Other	
VCC	AC28	Power/Other	
VCC	AC29	Power/Other	
VCC	AC30	Power/Other	
VCC	AC8	Power/Other	
VCC	AD23	Power/Other	
VCC	AD24	Power/Other	
VCC	AD25	Power/Other	
VCC	AD26	Power/Other	
VCC	AD27	Power/Other	
VCC	AD28	Power/Other	
VCC	AD29	Power/Other	
VCC	AD30	Power/Other	
VCC	AD8	Power/Other	
VCC	AE11	Power/Other	
VCC	AE12	Power/Other	
VCC	AE14	Power/Other	
VCC	AE15	Power/Other	
VCC	AE18	Power/Other	
VCC	AE19	Power/Other	
VCC	AE21	Power/Other	
VCC	AE22	Power/Other	
VCC	AE23	Power/Other	
VCC	AE9	Power/Other	
VCC	AF11	Power/Other	
VCC	AF12	Power/Other	
VCC	AF14	Power/Other	
VCC	AF15	Power/Other	
VCC	AF18	Power/Other	
VCC	AF19	Power/Other	
VCC	AF21	Power/Other	
VCC	AF22	Power/Other	

Table 23. Alphabetical Land Assignments

Land Name	Land #	Signal Buffer Type	Direction
VCC	AF8	Power/Other	
VCC	AF9	Power/Other	
VCC	AG11	Power/Other	
VCC	AG12	Power/Other	
VCC	AG14	Power/Other	
VCC	AG15	Power/Other	
VCC	AG18	Power/Other	
VCC	AG19	Power/Other	
VCC	AG21	Power/Other	
VCC	AG22	Power/Other	
VCC	AG25	Power/Other	
VCC	AG26	Power/Other	
VCC	AG27	Power/Other	
VCC	AG28	Power/Other	
VCC	AG29	Power/Other	
VCC	AG30	Power/Other	
VCC	AG8	Power/Other	
VCC	AG9	Power/Other	
VCC	AH11	Power/Other	
VCC	AH12	Power/Other	
VCC	AH14	Power/Other	
VCC	AH15	Power/Other	
VCC	AH18	Power/Other	
VCC	AH19	Power/Other	
VCC	AH21	Power/Other	
VCC	AH22	Power/Other	
VCC	AH25	Power/Other	
VCC	AH26	Power/Other	
VCC	AH27	Power/Other	
VCC	AH28	Power/Other	
VCC	AH29	Power/Other	
VCC	AH30	Power/Other	
VCC	AH8	Power/Other	
VCC	AH9	Power/Other	
VCC	AJ11	Power/Other	
VCC	AJ12	Power/Other	
VCC	AJ14	Power/Other	
VCC	AJ15	Power/Other	
VCC	AJ18	Power/Other	

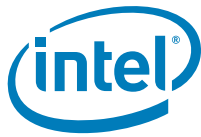


Table 23. Alphabetical Land Assignments

Land Name	Land #	Signal Buffer Type	Direction
VCC	AJ19	Power/Other	
VCC	AJ21	Power/Other	
VCC	AJ22	Power/Other	
VCC	AJ25	Power/Other	
VCC	AJ26	Power/Other	
VCC	AJ8	Power/Other	
VCC	AJ9	Power/Other	
VCC	AK11	Power/Other	
VCC	AK12	Power/Other	
VCC	AK14	Power/Other	
VCC	AK15	Power/Other	
VCC	AK18	Power/Other	
VCC	AK19	Power/Other	
VCC	AK21	Power/Other	
VCC	AK22	Power/Other	
VCC	AK25	Power/Other	
VCC	AK26	Power/Other	
VCC	AK8	Power/Other	
VCC	AK9	Power/Other	
VCC	AL11	Power/Other	
VCC	AL12	Power/Other	
VCC	AL14	Power/Other	
VCC	AL15	Power/Other	
VCC	AL18	Power/Other	
VCC	AL19	Power/Other	
VCC	AL21	Power/Other	
VCC	AL22	Power/Other	
VCC	AL25	Power/Other	
VCC	AL26	Power/Other	
VCC	AL29	Power/Other	
VCC	AL30	Power/Other	
VCC	AL8	Power/Other	
VCC	AL9	Power/Other	
VCC	AM11	Power/Other	
VCC	AM12	Power/Other	
VCC	AM14	Power/Other	
VCC	AM15	Power/Other	
VCC	AM18	Power/Other	
VCC	AM19	Power/Other	

Table 23. Alphabetical Land Assignments

Land Name	Land #	Signal Buffer Type	Direction
VCC	AM21	Power/Other	
VCC	AM22	Power/Other	
VCC	AM25	Power/Other	
VCC	AM26	Power/Other	
VCC	AM29	Power/Other	
VCC	AM30	Power/Other	
VCC	AM8	Power/Other	
VCC	AM9	Power/Other	
VCC	AN11	Power/Other	
VCC	AN12	Power/Other	
VCC	AN14	Power/Other	
VCC	AN15	Power/Other	
VCC	AN18	Power/Other	
VCC	AN19	Power/Other	
VCC	AN21	Power/Other	
VCC	AN22	Power/Other	
VCC	AN25	Power/Other	
VCC	AN26	Power/Other	
VCC	AN29	Power/Other	
VCC	AN30	Power/Other	
VCC	AN8	Power/Other	
VCC	AN9	Power/Other	
VCC	J10	Power/Other	
VCC	J11	Power/Other	
VCC	J12	Power/Other	
VCC	J13	Power/Other	
VCC	J14	Power/Other	
VCC	J15	Power/Other	
VCC	J18	Power/Other	
VCC	J19	Power/Other	
VCC	J20	Power/Other	
VCC	J21	Power/Other	
VCC	J22	Power/Other	
VCC	J23	Power/Other	
VCC	J24	Power/Other	
VCC	J25	Power/Other	
VCC	J26	Power/Other	
VCC	J27	Power/Other	
VCC	J28	Power/Other	

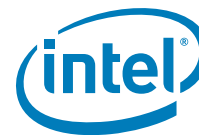


Table 23. Alphabetical Land Assignments

Land Name	Land #	Signal Buffer Type	Direction
VCC	J29	Power/Other	
VCC	J30	Power/Other	
VCC	J8	Power/Other	
VCC	J9	Power/Other	
VCC	K23	Power/Other	
VCC	K24	Power/Other	
VCC	K25	Power/Other	
VCC	K26	Power/Other	
VCC	K27	Power/Other	
VCC	K28	Power/Other	
VCC	K29	Power/Other	
VCC	K30	Power/Other	
VCC	K8	Power/Other	
VCC	L8	Power/Other	
VCC	M23	Power/Other	
VCC	M24	Power/Other	
VCC	M25	Power/Other	
VCC	M26	Power/Other	
VCC	M27	Power/Other	
VCC	M28	Power/Other	
VCC	M29	Power/Other	
VCC	M30	Power/Other	
VCC	M8	Power/Other	
VCC	N23	Power/Other	
VCC	N24	Power/Other	
VCC	N25	Power/Other	
VCC	N26	Power/Other	
VCC	N27	Power/Other	
VCC	N28	Power/Other	
VCC	N29	Power/Other	
VCC	N30	Power/Other	
VCC	N8	Power/Other	
VCC	P8	Power/Other	
VCC	R8	Power/Other	
VCC	T23	Power/Other	
VCC	T24	Power/Other	
VCC	T25	Power/Other	
VCC	T26	Power/Other	
VCC	T27	Power/Other	

Table 23. Alphabetical Land Assignments

Land Name	Land #	Signal Buffer Type	Direction
VCC	T28	Power/Other	
VCC	T29	Power/Other	
VCC	T30	Power/Other	
VCC	T8	Power/Other	
VCC	U23	Power/Other	
VCC	U24	Power/Other	
VCC	U25	Power/Other	
VCC	U26	Power/Other	
VCC	U27	Power/Other	
VCC	U28	Power/Other	
VCC	U29	Power/Other	
VCC	U30	Power/Other	
VCC	U8	Power/Other	
VCC	V8	Power/Other	
VCC	W23	Power/Other	
VCC	W24	Power/Other	
VCC	W25	Power/Other	
VCC	W26	Power/Other	
VCC	W27	Power/Other	
VCC	W28	Power/Other	
VCC	W29	Power/Other	
VCC	W30	Power/Other	
VCC	W8	Power/Other	
VCC	Y23	Power/Other	
VCC	Y24	Power/Other	
VCC	Y25	Power/Other	
VCC	Y26	Power/Other	
VCC	Y27	Power/Other	
VCC	Y28	Power/Other	
VCC	Y29	Power/Other	
VCC	Y30	Power/Other	
VCC	Y8	Power/Other	
VCC_MB_REGULATION	AN5	Power/Other	Output
VCC_SENSE	AN3	Power/Other	Output
VCCA	A23	Power/Other	
VCCIOPLL	C23	Power/Other	
VID0	AM2	Power/Other	Output
VID1	AL5	Power/Other	Output
VID2	AM3	Power/Other	Output

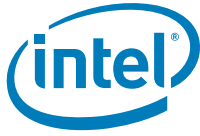


Table 23. Alphabetical Land Assignments

Land Name	Land #	Signal Buffer Type	Direction
VID3	AL6	Power/Other	Output
VID4	AK4	Power/Other	Output
VID5	AL4	Power/Other	Output
VSS	B1	Power/Other	
VSS	B11	Power/Other	
VSS	B14	Power/Other	
VSS	B17	Power/Other	
VSS	B20	Power/Other	
VSS	B24	Power/Other	
VSS	B5	Power/Other	
VSS	B8	Power/Other	
VSS	A12	Power/Other	
VSS	A15	Power/Other	
VSS	A18	Power/Other	
VSS	A2	Power/Other	
VSS	A21	Power/Other	
VSS	A24	Power/Other	
VSS	A6	Power/Other	
VSS	A9	Power/Other	
VSS	AA23	Power/Other	
VSS	AA24	Power/Other	
VSS	AA25	Power/Other	
VSS	AA26	Power/Other	
VSS	AA27	Power/Other	
VSS	AA28	Power/Other	
VSS	AA29	Power/Other	
VSS	AA3	Power/Other	
VSS	AA30	Power/Other	
VSS	AA6	Power/Other	
VSS	AA7	Power/Other	
VSS	AB1	Power/Other	
VSS	AB23	Power/Other	
VSS	AB24	Power/Other	
VSS	AB25	Power/Other	
VSS	AB26	Power/Other	
VSS	AB27	Power/Other	
VSS	AB28	Power/Other	
VSS	AB29	Power/Other	
VSS	AB30	Power/Other	

Table 23. Alphabetical Land Assignments

Land Name	Land #	Signal Buffer Type	Direction
VSS	AB7	Power/Other	
VSS	AC3	Power/Other	
VSS	AC6	Power/Other	
VSS	AC7	Power/Other	
VSS	AD4	Power/Other	
VSS	AD7	Power/Other	
VSS	AE10	Power/Other	
VSS	AE13	Power/Other	
VSS	AE16	Power/Other	
VSS	AE17	Power/Other	
VSS	AE2	Power/Other	
VSS	AE20	Power/Other	
VSS	AE24	Power/Other	
VSS	AE25	Power/Other	
VSS	AE26	Power/Other	
VSS	AE27	Power/Other	
VSS	AE28	Power/Other	
VSS	AE29	Power/Other	
VSS	AE30	Power/Other	
VSS	AE5	Power/Other	
VSS	AE7	Power/Other	
VSS	AF10	Power/Other	
VSS	AF13	Power/Other	
VSS	AF16	Power/Other	
VSS	AF17	Power/Other	
VSS	AF20	Power/Other	
VSS	AF23	Power/Other	
VSS	AF24	Power/Other	
VSS	AF25	Power/Other	
VSS	AF26	Power/Other	
VSS	AF27	Power/Other	
VSS	AF28	Power/Other	
VSS	AF29	Power/Other	
VSS	AF3	Power/Other	
VSS	AF30	Power/Other	
VSS	AF6	Power/Other	
VSS	AF7	Power/Other	
VSS	AG10	Power/Other	
VSS	AG13	Power/Other	

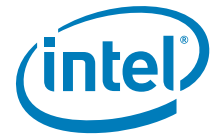


Table 23. Alphabetical Land Assignments

Land Name	Land #	Signal Buffer Type	Direction
VSS	AG16	Power/Other	
VSS	AG17	Power/Other	
VSS	AG20	Power/Other	
VSS	AG23	Power/Other	
VSS	AG24	Power/Other	
VSS	AG7	Power/Other	
VSS	AH1	Power/Other	
VSS	AH10	Power/Other	
VSS	AH13	Power/Other	
VSS	AH16	Power/Other	
VSS	AH17	Power/Other	
VSS	AH20	Power/Other	
VSS	AH23	Power/Other	
VSS	AH24	Power/Other	
VSS	AH3	Power/Other	
VSS	AH6	Power/Other	
VSS	AH7	Power/Other	
VSS	AJ10	Power/Other	
VSS	AJ13	Power/Other	
VSS	AJ16	Power/Other	
VSS	AJ17	Power/Other	
VSS	AJ20	Power/Other	
VSS	AJ23	Power/Other	
VSS	AJ24	Power/Other	
VSS	AJ27	Power/Other	
VSS	AJ28	Power/Other	
VSS	AJ29	Power/Other	
VSS	AJ30	Power/Other	
VSS	AJ4	Power/Other	
VSS	AJ7	Power/Other	
VSS	AK10	Power/Other	
VSS	AK13	Power/Other	
VSS	AK16	Power/Other	
VSS	AK17	Power/Other	
VSS	AK2	Power/Other	
VSS	AK20	Power/Other	
VSS	AK23	Power/Other	
VSS	AK24	Power/Other	
VSS	AK27	Power/Other	

Table 23. Alphabetical Land Assignments

Land Name	Land #	Signal Buffer Type	Direction
VSS	AK28	Power/Other	
VSS	AK29	Power/Other	
VSS	AK30	Power/Other	
VSS	AK5	Power/Other	
VSS	AK7	Power/Other	
VSS	AL10	Power/Other	
VSS	AL13	Power/Other	
VSS	AL16	Power/Other	
VSS	AL17	Power/Other	
VSS	AL20	Power/Other	
VSS	AL23	Power/Other	
VSS	AL24	Power/Other	
VSS	AL27	Power/Other	
VSS	AL28	Power/Other	
VSS	AL3	Power/Other	
VSS	AL7	Power/Other	
VSS	AM1	Power/Other	
VSS	AM10	Power/Other	
VSS	AM13	Power/Other	
VSS	AM16	Power/Other	
VSS	AM17	Power/Other	
VSS	AM20	Power/Other	
VSS	AM23	Power/Other	
VSS	AM24	Power/Other	
VSS	AM27	Power/Other	
VSS	AM28	Power/Other	
VSS	AM4	Power/Other	
VSS	AN1	Power/Other	
VSS	AN10	Power/Other	
VSS	AN13	Power/Other	
VSS	AN16	Power/Other	
VSS	AN17	Power/Other	
VSS	AN2	Power/Other	
VSS	AN20	Power/Other	
VSS	AN23	Power/Other	
VSS	AN24	Power/Other	
VSS	AN27	Power/Other	
VSS	AN28	Power/Other	
VSS	C10	Power/Other	

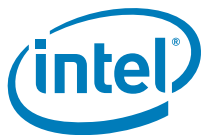


Table 23. Alphabetical Land Assignments

Land Name	Land #	Signal Buffer Type	Direction
VSS	C13	Power/Other	
VSS	C16	Power/Other	
VSS	C19	Power/Other	
VSS	C22	Power/Other	
VSS	C24	Power/Other	
VSS	C4	Power/Other	
VSS	C7	Power/Other	
VSS	D12	Power/Other	
VSS	D15	Power/Other	
VSS	D18	Power/Other	
VSS	D21	Power/Other	
VSS	D24	Power/Other	
VSS	D3	Power/Other	
VSS	D5	Power/Other	
VSS	D6	Power/Other	
VSS	D9	Power/Other	
VSS	E11	Power/Other	
VSS	E14	Power/Other	
VSS	E17	Power/Other	
VSS	E2	Power/Other	
VSS	E20	Power/Other	
VSS	E25	Power/Other	
VSS	E26	Power/Other	
VSS	E27	Power/Other	
VSS	E28	Power/Other	
VSS	E29	Power/Other	
VSS	E8	Power/Other	
VSS	F10	Power/Other	
VSS	F13	Power/Other	
VSS	F16	Power/Other	
VSS	F19	Power/Other	
VSS	F22	Power/Other	
VSS	F4	Power/Other	
VSS	F7	Power/Other	
VSS	G1	Power/Other	
VSS	H10	Power/Other	
VSS	H11	Power/Other	
VSS	H12	Power/Other	
VSS	H13	Power/Other	

Table 23. Alphabetical Land Assignments

Land Name	Land #	Signal Buffer Type	Direction
VSS	H14	Power/Other	
VSS	H17	Power/Other	
VSS	H18	Power/Other	
VSS	H19	Power/Other	
VSS	H20	Power/Other	
VSS	H21	Power/Other	
VSS	H22	Power/Other	
VSS	H23	Power/Other	
VSS	H24	Power/Other	
VSS	H25	Power/Other	
VSS	H26	Power/Other	
VSS	H27	Power/Other	
VSS	H28	Power/Other	
VSS	H3	Power/Other	
VSS	H6	Power/Other	
VSS	H7	Power/Other	
VSS	H8	Power/Other	
VSS	H9	Power/Other	
VSS	J4	Power/Other	
VSS	J7	Power/Other	
VSS	K2	Power/Other	
VSS	K5	Power/Other	
VSS	K7	Power/Other	
VSS	L23	Power/Other	
VSS	L24	Power/Other	
VSS	L25	Power/Other	
VSS	L26	Power/Other	
VSS	L27	Power/Other	
VSS	L28	Power/Other	
VSS	L29	Power/Other	
VSS	L3	Power/Other	
VSS	L30	Power/Other	
VSS	L6	Power/Other	
VSS	L7	Power/Other	
VSS	M1	Power/Other	
VSS	M7	Power/Other	
VSS	N3	Power/Other	
VSS	N6	Power/Other	
VSS	N7	Power/Other	



Table 23. Alphabetical Land Assignments

Land Name	Land #	Signal Buffer Type	Direction
VSS	P23	Power/Other	
VSS	P24	Power/Other	
VSS	P25	Power/Other	
VSS	P26	Power/Other	
VSS	P27	Power/Other	
VSS	P28	Power/Other	
VSS	P29	Power/Other	
VSS	P30	Power/Other	
VSS	P4	Power/Other	
VSS	P7	Power/Other	
VSS	R2	Power/Other	
VSS	R23	Power/Other	
VSS	R24	Power/Other	
VSS	R25	Power/Other	
VSS	R26	Power/Other	
VSS	R27	Power/Other	
VSS	R28	Power/Other	
VSS	R29	Power/Other	
VSS	R30	Power/Other	
VSS	R5	Power/Other	
VSS	R7	Power/Other	
VSS	T3	Power/Other	
VSS	T6	Power/Other	
VSS	T7	Power/Other	
VSS	U1	Power/Other	
VSS	U7	Power/Other	
VSS	V23	Power/Other	
VSS	V24	Power/Other	
VSS	V25	Power/Other	
VSS	V26	Power/Other	
VSS	V27	Power/Other	
VSS	V28	Power/Other	
VSS	V29	Power/Other	
VSS	V3	Power/Other	
VSS	V30	Power/Other	
VSS	V6	Power/Other	
VSS	V7	Power/Other	
VSS	W4	Power/Other	
VSS	W7	Power/Other	

Table 23. Alphabetical Land Assignments

Land Name	Land #	Signal Buffer Type	Direction
VSS	Y2	Power/Other	
VSS	Y5	Power/Other	
VSS	Y7	Power/Other	
VSS_MB_REGULATION	AN6	Power/Other	Output
VSS_SENSE	AN4	Power/Other	Output
VSSA	B23	Power/Other	
VTT	B25	Power/Other	
VTT	B26	Power/Other	
VTT	B27	Power/Other	
VTT	B28	Power/Other	
VTT	B29	Power/Other	
VTT	B30	Power/Other	
VTT	A25	Power/Other	
VTT	A26	Power/Other	
VTT	A27	Power/Other	
VTT	A28	Power/Other	
VTT	A29	Power/Other	
VTT	A30	Power/Other	
VTT	C25	Power/Other	
VTT	C26	Power/Other	
VTT	C27	Power/Other	
VTT	C28	Power/Other	
VTT	C29	Power/Other	
VTT	C30	Power/Other	
VTT	D25	Power/Other	
VTT	D26	Power/Other	
VTT	D27	Power/Other	
VTT	D28	Power/Other	
VTT	D29	Power/Other	
VTT	D30	Power/Other	
VTT_OUT_LEFT	J1	Power/Other	Output
VTT_OUT_RIGHT	AA1	Power/Other	Output
VTT_SEL	F27	Power/Other	Output
VTTTPWRGD	AM6	Power/Other	Input

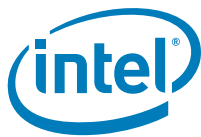


Table 24. Numerical Land Assignment

Land #	Land Name	Signal Buffer Type	Direction
A10	D08#	Source Synch	Input/Output
A11	D09#	Source Synch	Input/Output
A12	VSS	Power/Other	
A13	COMPO	Power/Other	Input
A14	D50#	Source Synch	Input/Output
A15	VSS	Power/Other	
A16	DSTBN3#	Source Synch	Input/Output
A17	D56#	Source Synch	Input/Output
A18	VSS	Power/Other	
A19	D61#	Source Synch	Input/Output
A2	VSS	Power/Other	
A20	RESERVED		
A21	VSS	Power/Other	
A22	D62#	Source Synch	Input/Output
A23	VCCA	Power/Other	
A24	VSS	Power/Other	
A25	VTT	Power/Other	
A26	VTT	Power/Other	
A27	VTT	Power/Other	
A28	VTT	Power/Other	
A29	VTT	Power/Other	
A3	RS2#	Common Clock	Input
A30	VTT	Power/Other	
A4	D02#	Source Synch	Input/Output
A5	D04#	Source Synch	Input/Output
A6	VSS	Power/Other	
A7	D07#	Source Synch	Input/Output
A8	DBI0#	Source Synch	Input/Output
A9	VSS	Power/Other	
AA1	VTT_OUT_RIGHT	Power/Other	Output
AA2	LL_ID1	Power/Other	Output
AA23	VSS	Power/Other	
AA24	VSS	Power/Other	
AA25	VSS	Power/Other	
AA26	VSS	Power/Other	
AA27	VSS	Power/Other	
AA28	VSS	Power/Other	
AA29	VSS	Power/Other	
AA3	VSS	Power/Other	
AA30	VSS	Power/Other	

Table 24. Numerical Land Assignment

Land #	Land Name	Signal Buffer Type	Direction
AA4	A21#	Source Synch	Input/Output
AA5	A23#	Source Synch	Input/Output
AA6	VSS	Power/Other	
AA7	VSS	Power/Other	
AA8	VCC	Power/Other	
AB1	VSS	Power/Other	
AB2	IERR#	Asynch GTL+	Output
AB23	VSS	Power/Other	
AB24	VSS	Power/Other	
AB25	VSS	Power/Other	
AB26	VSS	Power/Other	
AB27	VSS	Power/Other	
AB28	VSS	Power/Other	
AB29	VSS	Power/Other	
AB3	MCERR#	Common Clock	Input/Output
AB30	VSS	Power/Other	
AB4	A26#	Source Synch	Input/Output
AB5	A24#	Source Synch	Input/Output
AB6	A17#	Source Synch	Input/Output
AB7	VSS	Power/Other	
AB8	VCC	Power/Other	
AC1	TMS	TAP	Input
AC2	DBR#	Power/Other	Output
AC23	VCC	Power/Other	
AC24	VCC	Power/Other	
AC25	VCC	Power/Other	
AC26	VCC	Power/Other	
AC27	VCC	Power/Other	
AC28	VCC	Power/Other	
AC29	VCC	Power/Other	
AC3	VSS	Power/Other	
AC30	VCC	Power/Other	
AC4	RESERVED		
AC5	A25#	Source Synch	Input/Output
AC6	VSS	Power/Other	
AC7	VSS	Power/Other	
AC8	VCC	Power/Other	
AD1	TDI	TAP	Input
AD2	BPM2#	Common Clock	Input/Output
AD23	VCC	Power/Other	

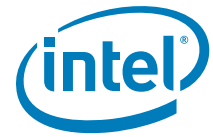


Table 24. Numerical Land Assignment

Land #	Land Name	Signal Buffer Type	Direction
AD24	VCC	Power/Other	
AD25	VCC	Power/Other	
AD26	VCC	Power/Other	
AD27	VCC	Power/Other	
AD28	VCC	Power/Other	
AD29	VCC	Power/Other	
AD3	BINIT#	Common Clock	Input/Output
AD30	VCC	Power/Other	
AD4	VSS	Power/Other	
AD5	ADSTB1#	Source Synch	Input/Output
AD6	A22#	Source Synch	Input/Output
AD7	VSS	Power/Other	
AD8	VCC	Power/Other	
AE1	TCK	TAP	Input
AE10	VSS	Power/Other	
AE11	VCC	Power/Other	
AE12	VCC	Power/Other	
AE13	VSS	Power/Other	
AE14	VCC	Power/Other	
AE15	VCC	Power/Other	
AE16	VSS	Power/Other	
AE17	VSS	Power/Other	
AE18	VCC	Power/Other	
AE19	VCC	Power/Other	
AE2	VSS	Power/Other	
AE20	VSS	Power/Other	
AE21	VCC	Power/Other	
AE22	VCC	Power/Other	
AE23	VCC	Power/Other	
AE24	VSS	Power/Other	
AE25	VSS	Power/Other	
AE26	VSS	Power/Other	
AE27	VSS	Power/Other	
AE28	VSS	Power/Other	
AE29	VSS	Power/Other	
AE3	FC18	Power/Other	Output
AE30	VSS	Power/Other	
AE4	RESERVED		
AE5	VSS	Power/Other	
AE6	RESERVED		

Table 24. Numerical Land Assignment

Land #	Land Name	Signal Buffer Type	Direction
AE7	VSS	Power/Other	
AE8	SKTOCC#	Power/Other	Output
AE9	VCC	Power/Other	
AF1	TDO	TAP	Output
AF10	VSS	Power/Other	
AF11	VCC	Power/Other	
AF12	VCC	Power/Other	
AF13	VSS	Power/Other	
AF14	VCC	Power/Other	
AF15	VCC	Power/Other	
AF16	VSS	Power/Other	
AF17	VSS	Power/Other	
AF18	VCC	Power/Other	
AF19	VCC	Power/Other	
AF2	BPM4#	Common Clock	Input/Output
AF20	VSS	Power/Other	
AF21	VCC	Power/Other	
AF22	VCC	Power/Other	
AF23	VSS	Power/Other	
AF24	VSS	Power/Other	
AF25	VSS	Power/Other	
AF26	VSS	Power/Other	
AF27	VSS	Power/Other	
AF28	VSS	Power/Other	
AF29	VSS	Power/Other	
AF3	VSS	Power/Other	
AF30	VSS	Power/Other	
AF4	A28#	Source Synch	Input/Output
AF5	A27#	Source Synch	Input/Output
AF6	VSS	Power/Other	
AF7	VSS	Power/Other	
AF8	VCC	Power/Other	
AF9	VCC	Power/Other	
AG1	TRST#	TAP	Input
AG10	VSS	Power/Other	
AG11	VCC	Power/Other	
AG12	VCC	Power/Other	
AG13	VSS	Power/Other	
AG14	VCC	Power/Other	
AG15	VCC	Power/Other	

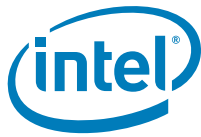


Table 24. Numerical Land Assignment

Land #	Land Name	Signal Buffer Type	Direction
AG16	VSS	Power/Other	
AG17	VSS	Power/Other	
AG18	VCC	Power/Other	
AG19	VCC	Power/Other	
AG2	BPM3#	Common Clock	Input/Output
AG20	VSS	Power/Other	
AG21	VCC	Power/Other	
AG22	VCC	Power/Other	
AG23	VSS	Power/Other	
AG24	VSS	Power/Other	
AG25	VCC	Power/Other	
AG26	VCC	Power/Other	
AG27	VCC	Power/Other	
AG28	VCC	Power/Other	
AG29	VCC	Power/Other	
AG3	BPM5#	Common Clock	Input/Output
AG30	VCC	Power/Other	
AG4	A30#	Source Synch	Input/Output
AG5	A31#	Source Synch	Input/Output
AG6	A29#	Source Synch	Input/Output
AG7	VSS	Power/Other	
AG8	VCC	Power/Other	
AG9	VCC	Power/Other	
AH1	VSS	Power/Other	
AH10	VSS	Power/Other	
AH11	VCC	Power/Other	
AH12	VCC	Power/Other	
AH13	VSS	Power/Other	
AH14	VCC	Power/Other	
AH15	VCC	Power/Other	
AH16	VSS	Power/Other	
AH17	VSS	Power/Other	
AH18	VCC	Power/Other	
AH19	VCC	Power/Other	
AH2	RESERVED		
AH20	VSS	Power/Other	
AH21	VCC	Power/Other	
AH22	VCC	Power/Other	
AH23	VSS	Power/Other	
AH24	VSS	Power/Other	

Table 24. Numerical Land Assignment

Land #	Land Name	Signal Buffer Type	Direction
AH25	VCC	Power/Other	
AH26	VCC	Power/Other	
AH27	VCC	Power/Other	
AH28	VCC	Power/Other	
AH29	VCC	Power/Other	
AH3	VSS	Power/Other	
AH30	VCC	Power/Other	
AH4	A32#	Source Synch	Input/Output
AH5	A33#	Source Synch	Input/Output
AH6	VSS	Power/Other	
AH7	VSS	Power/Other	
AH8	VCC	Power/Other	
AH9	VCC	Power/Other	
AJ1	BPM1#	Common Clock	Input/Output
AJ10	VSS	Power/Other	
AJ11	VCC	Power/Other	
AJ12	VCC	Power/Other	
AJ13	VSS	Power/Other	
AJ14	VCC	Power/Other	
AJ15	VCC	Power/Other	
AJ16	VSS	Power/Other	
AJ17	VSS	Power/Other	
AJ18	VCC	Power/Other	
AJ19	VCC	Power/Other	
AJ2	BPM0#	Common Clock	Input/Output
AJ20	VSS	Power/Other	
AJ21	VCC	Power/Other	
AJ22	VCC	Power/Other	
AJ23	VSS	Power/Other	
AJ24	VSS	Power/Other	
AJ25	VCC	Power/Other	
AJ26	VCC	Power/Other	
AJ27	VSS	Power/Other	
AJ28	VSS	Power/Other	
AJ29	VSS	Power/Other	
AJ3	ITP_CLK1	TAP	Input
AJ30	VSS	Power/Other	
AJ4	VSS	Power/Other	
AJ5	A34#	Source Synch	Input/Output
AJ6	A35#	Source Synch	Input/Output

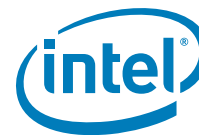


Table 24. Numerical Land Assignment

Land #	Land Name	Signal Buffer Type	Direction
AJ7	VSS	Power/Other	
AJ8	VCC	Power/Other	
AJ9	VCC	Power/Other	
AK1	THERMDC	Power/Other	
AK10	VSS	Power/Other	
AK11	VCC	Power/Other	
AK12	VCC	Power/Other	
AK13	VSS	Power/Other	
AK14	VCC	Power/Other	
AK15	VCC	Power/Other	
AK16	VSS	Power/Other	
AK17	VSS	Power/Other	
AK18	VCC	Power/Other	
AK19	VCC	Power/Other	
AK2	VSS	Power/Other	
AK20	VSS	Power/Other	
AK21	VCC	Power/Other	
AK22	VCC	Power/Other	
AK23	VSS	Power/Other	
AK24	VSS	Power/Other	
AK25	VCC	Power/Other	
AK26	VCC	Power/Other	
AK27	VSS	Power/Other	
AK28	VSS	Power/Other	
AK29	VSS	Power/Other	
AK3	ITP_CLK0	TAP	Input
AK30	VSS	Power/Other	
AK4	VID4	Power/Other	Output
AK5	VSS	Power/Other	
AK6	FC8		
AK7	VSS	Power/Other	
AK8	VCC	Power/Other	
AK9	VCC	Power/Other	
AL1	THERMDA	Power/Other	
AL10	VSS	Power/Other	
AL11	VCC	Power/Other	
AL12	VCC	Power/Other	
AL13	VSS	Power/Other	
AL14	VCC	Power/Other	
AL15	VCC	Power/Other	

Table 24. Numerical Land Assignment

Land #	Land Name	Signal Buffer Type	Direction
AL16	VSS	Power/Other	
AL17	VSS	Power/Other	
AL18	VCC	Power/Other	
AL19	VCC	Power/Other	
AL2	PROCHOT#	Asynch GTL+	Input/Output
AL20	VSS	Power/Other	
AL21	VCC	Power/Other	
AL22	VCC	Power/Other	
AL23	VSS	Power/Other	
AL24	VSS	Power/Other	
AL25	VCC	Power/Other	
AL26	VCC	Power/Other	
AL27	VSS	Power/Other	
AL28	VSS	Power/Other	
AL29	VCC	Power/Other	
AL3	VSS	Power/Other	
AL30	VCC	Power/Other	
AL4	VID5	Power/Other	Output
AL5	VID1	Power/Other	Output
AL6	VID3	Power/Other	Output
AL7	VSS	Power/Other	
AL8	VCC	Power/Other	
AL9	VCC	Power/Other	
AM1	VSS	Power/Other	
AM10	VSS	Power/Other	
AM11	VCC	Power/Other	
AM12	VCC	Power/Other	
AM13	VSS	Power/Other	
AM14	VCC	Power/Other	
AM15	VCC	Power/Other	
AM16	VSS	Power/Other	
AM17	VSS	Power/Other	
AM18	VCC	Power/Other	
AM19	VCC	Power/Other	
AM2	VID0	Power/Other	Output
AM20	VSS	Power/Other	
AM21	VCC	Power/Other	
AM22	VCC	Power/Other	
AM23	VSS	Power/Other	
AM24	VSS	Power/Other	



Table 24. Numerical Land Assignment

Land #	Land Name	Signal Buffer Type	Direction
AM25	VCC	Power/Other	
AM26	VCC	Power/Other	
AM27	VSS	Power/Other	
AM28	VSS	Power/Other	
AM29	VCC	Power/Other	
AM3	VID2	Power/Other	Output
AM30	VCC	Power/Other	
AM4	VSS	Power/Other	
AM5	FC11	Power/Other	Output
AM6	VTTPWRGD	Power/Other	Input
AM7	FC12	Power/Other	Output
AM8	VCC	Power/Other	
AM9	VCC	Power/Other	
AN1	VSS	Power/Other	
AN10	VSS	Power/Other	
AN11	VCC	Power/Other	
AN12	VCC	Power/Other	
AN13	VSS	Power/Other	
AN14	VCC	Power/Other	
AN15	VCC	Power/Other	
AN16	VSS	Power/Other	
AN17	VSS	Power/Other	
AN18	VCC	Power/Other	
AN19	VCC	Power/Other	
AN2	VSS	Power/Other	
AN20	VSS	Power/Other	
AN21	VCC	Power/Other	
AN22	VCC	Power/Other	
AN23	VSS	Power/Other	
AN24	VSS	Power/Other	
AN25	VCC	Power/Other	
AN26	VCC	Power/Other	
AN27	VSS	Power/Other	
AN28	VSS	Power/Other	
AN29	VCC	Power/Other	
AN3	VCC_SENSE	Power/Other	Output
AN30	VCC	Power/Other	
AN4	VSS_SENSE	Power/Other	Output
AN5	VCC_MB_REGULATION	Power/Other	Output

Table 24. Numerical Land Assignment

Land #	Land Name	Signal Buffer Type	Direction
AN6	VSS_MB_REGULATION	Power/Other	Output
AN7	FC16	Power/Other	Output
AN8	VCC	Power/Other	
AN9	VCC	Power/Other	
B1	VSS	Power/Other	
B10	D10#	Source Synch	Input/Output
B11	VSS	Power/Other	
B12	D13#	Source Synch	Input/Output
B13	FC19	Power/Other	Output
B14	VSS	Power/Other	
B15	D53#	Source Synch	Input/Output
B16	D55#	Source Synch	Input/Output
B17	VSS	Power/Other	
B18	D57#	Source Synch	Input/Output
B19	D60#	Source Synch	Input/Output
B2	DBSY#	Common Clock	Input/Output
B20	VSS	Power/Other	
B21	D59#	Source Synch	Input/Output
B22	D63#	Source Synch	Input/Output
B23	VSSA	Power/Other	
B24	VSS	Power/Other	
B25	VTT	Power/Other	
B26	VTT	Power/Other	
B27	VTT	Power/Other	
B28	VTT	Power/Other	
B29	VTT	Power/Other	
B3	RS0#	Common Clock	Input
B30	VTT	Power/Other	
B4	D00#	Source Synch	Input/Output
B5	VSS	Power/Other	
B6	D05#	Source Synch	Input/Output
B7	D06#	Source Synch	Input/Output
B8	VSS	Power/Other	
B9	DSTBP0#	Source Synch	Input/Output
C1	DRDY#	Common Clock	Input/Output
C10	VSS	Power/Other	
C11	D11#	Source Synch	Input/Output
C12	D14#	Source Synch	Input/Output
C13	VSS	Power/Other	
C14	D52#	Source Synch	Input/Output

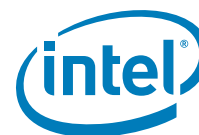


Table 24. Numerical Land Assignment

Land #	Land Name	Signal Buffer Type	Direction
C15	D51#	Source Synch	Input/Output
C16	VSS	Power/Other	
C17	DSTBP3#	Source Synch	Input/Output
C18	D54#	Source Synch	Input/Output
C19	VSS	Power/Other	
C2	BNR#	Common Clock	Input/Output
C20	DBI3#	Source Synch	Input/Output
C21	D58#	Source Synch	Input/Output
C22	VSS	Power/Other	
C23	VCCIOPLL	Power/Other	
C24	VSS	Power/Other	
C25	VTT	Power/Other	
C26	VTT	Power/Other	
C27	VTT	Power/Other	
C28	VTT	Power/Other	
C29	VTT	Power/Other	
C3	LOCK#	Common Clock	Input/Output
C30	VTT	Power/Other	
C4	VSS	Power/Other	
C5	D01#	Source Synch	Input/Output
C6	D03#	Source Synch	Input/Output
C7	VSS	Power/Other	
C8	DSTBNO#	Source Synch	Input/Output
C9	RESERVED		
D1	RESERVED		
D10	D22#	Source Synch	Input/Output
D11	D15#	Source Synch	Input/Output
D12	VSS	Power/Other	
D13	D25#	Source Synch	Input/Output
D14	RESERVED		
D15	VSS	Power/Other	
D16	RESERVED		
D17	D49#	Source Synch	Input/Output
D18	VSS	Power/Other	
D19	DBI2#	Source Synch	Input/Output
D2	ADS#	Common Clock	Input/Output
D20	D48#	Source Synch	Input/Output
D21	VSS	Power/Other	
D22	D46#	Source Synch	Input/Output
D23	FC9	Power/Other	Output

Table 24. Numerical Land Assignment

Land #	Land Name	Signal Buffer Type	Direction
D24	VSS	Power/Other	
D25	VTT	Power/Other	
D26	VTT	Power/Other	
D27	VTT	Power/Other	
D28	VTT	Power/Other	
D29	VTT	Power/Other	
D3	VSS	Power/Other	
D30	VTT	Power/Other	
D4	HIT#	Common Clock	Input/Output
D5	VSS	Power/Other	
D6	VSS	Power/Other	
D7	D20#	Source Synch	Input/Output
D8	D12#	Source Synch	Input/Output
D9	VSS	Power/Other	
E10	D21#	Source Synch	Input/Output
E11	VSS	Power/Other	
E12	DSTBP1#	Source Synch	Input/Output
E13	D26#	Source Synch	Input/Output
E14	VSS	Power/Other	
E15	D33#	Source Synch	Input/Output
E16	D34#	Source Synch	Input/Output
E17	VSS	Power/Other	
E18	D39#	Source Synch	Input/Output
E19	D40#	Source Synch	Input/Output
E2	VSS	Power/Other	
E20	VSS	Power/Other	
E21	D42#	Source Synch	Input/Output
E22	D45#	Source Synch	Input/Output
E23	RESERVED		
E24	FC10	Power/Other	Output
E25	VSS	Power/Other	
E26	VSS	Power/Other	
E27	VSS	Power/Other	
E28	VSS	Power/Other	
E29	VSS	Power/Other	
E3	TRDY#	Common Clock	Input
E4	HITM#	Common Clock	Input/Output
E5	FC20	Power/Other	Output
E6	RESERVED		
E7	RESERVED		



Table 24. Numerical Land Assignment

Land #	Land Name	Signal Buffer Type	Direction
E8	VSS	Power/Other	
E9	D19#	Source Synch	Input/Output
F10	VSS	Power/Other	
F11	D23#	Source Synch	Input/Output
F12	D24#	Source Synch	Input/Output
F13	VSS	Power/Other	
F14	D28#	Source Synch	Input/Output
F15	D30#	Source Synch	Input/Output
F16	VSS	Power/Other	
F17	D37#	Source Synch	Input/Output
F18	D38#	Source Synch	Input/Output
F19	VSS	Power/Other	
F2	FC5	Common Clock	Input
F20	D41#	Source Synch	Input/Output
F21	D43#	Source Synch	Input/Output
F22	VSS	Power/Other	
F23	RESERVED		
F24	TESTHI7	Power/Other	Input
F25	TESTHI2	Power/Other	Input
F26	TESTHI0	Power/Other	Input
F27	VTT_SEL	Power/Other	Output
F28	BCLK0	Clock	Input
F29	RESERVED		
F3	BR0#	Common Clock	Input/Output
F4	VSS	Power/Other	
F5	RS1#	Common Clock	Input
F6	IMPSEL	Power/Other	Input
F7	VSS	Power/Other	
F8	D17#	Source Synch	Input/Output
F9	D18#	Source Synch	Input/Output
G1	VSS	Power/Other	
G10	RESERVED		
G11	DBI1#	Source Synch	Input/Output
G12	DSTBN1#	Source Synch	Input/Output
G13	D27#	Source Synch	Input/Output
G14	D29#	Source Synch	Input/Output
G15	D31#	Source Synch	Input/Output
G16	D32#	Source Synch	Input/Output
G17	D36#	Source Synch	Input/Output
G18	D35#	Source Synch	Input/Output

Table 24. Numerical Land Assignment

Land #	Land Name	Signal Buffer Type	Direction
G19	DSTBP2#	Source Synch	Input/Output
G2	FC1	Power/Other	Input
G20	DSTBN2#	Source Synch	Input/Output
G21	D44#	Source Synch	Input/Output
G22	D47#	Source Synch	Input/Output
G23	RESET#	Common Clock	Input
G24	TESTHI6	Power/Other	Input
G25	TESTHI3	Power/Other	Input
G26	TESTHI5	Power/Other	Input
G27	TESTHI4	Power/Other	Input
G28	BCLK1	Clock	Input
G29	BSEL0	Power/Other	Output
G3	TESTHI8	Power/Other	Input
G30	BSEL2	Power/Other	Output
G4	TESTHI9	Power/Other	Input
G5	FC7	Source Synch	Output
G6	RESERVED		
G7	DEFER#	Common Clock	Input
G8	BPRI#	Common Clock	Input
G9	D16#	Source Synch	Input/Output
H1	GTLREF0	Power/Other	Input
H10	VSS	Power/Other	
H11	VSS	Power/Other	
H12	VSS	Power/Other	
H13	VSS	Power/Other	
H14	VSS	Power/Other	
H15	DP1#	Common Clock	Input/Output
H16	DP2#	Common Clock	Input/Output
H17	VSS	Power/Other	
H18	VSS	Power/Other	
H19	VSS	Power/Other	
H2	GTLREF1	Power/Other	Input
H20	VSS	Power/Other	
H21	VSS	Power/Other	
H22	VSS	Power/Other	
H23	VSS	Power/Other	
H24	VSS	Power/Other	
H25	VSS	Power/Other	
H26	VSS	Power/Other	
H27	VSS	Power/Other	

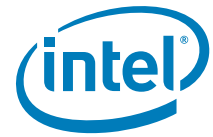


Table 24. Numerical Land Assignment

Land #	Land Name	Signal Buffer Type	Direction
H28	VSS	Power/Other	
H29	FC15	Power/Other	Output
H3	VSS	Power/Other	
H30	BSEL1	Power/Other	Output
H4	RSP#	Common Clock	Input
H5	TESTHI10	Power/Other	Input
H6	VSS	Power/Other	
H7	VSS	Power/Other	
H8	VSS	Power/Other	
H9	VSS	Power/Other	
J1	VTT_OUT_LEFT	Power/Other	Output
J10	VCC	Power/Other	
J11	VCC	Power/Other	
J12	VCC	Power/Other	
J13	VCC	Power/Other	
J14	VCC	Power/Other	
J15	VCC	Power/Other	
J16	DP0#	Common Clock	Input/Output
J17	DP3#	Common Clock	Input/Output
J18	VCC	Power/Other	
J19	VCC	Power/Other	
J2	COMP4	Power/Other	Input
J20	VCC	Power/Other	
J21	VCC	Power/Other	
J22	VCC	Power/Other	
J23	VCC	Power/Other	
J24	VCC	Power/Other	
J25	VCC	Power/Other	
J26	VCC	Power/Other	
J27	VCC	Power/Other	
J28	VCC	Power/Other	
J29	VCC	Power/Other	
J3	FC22	Power/Other	Output
J30	VCC	Power/Other	
J4	VSS	Power/Other	
J5	REQ1#	Source Synch	Input/Output
J6	REQ4#	Source Synch	Input/Output
J7	VSS	Power/Other	
J8	VCC	Power/Other	
J9	VCC	Power/Other	

Table 24. Numerical Land Assignment

Land #	Land Name	Signal Buffer Type	Direction
K1	LINT0	Asynch GTL+	Input
K2	VSS	Power/Other	
K23	VCC	Power/Other	
K24	VCC	Power/Other	
K25	VCC	Power/Other	
K26	VCC	Power/Other	
K27	VCC	Power/Other	
K28	VCC	Power/Other	
K29	VCC	Power/Other	
K3	A20M#	Asynch GTL+	Input
K30	VCC	Power/Other	
K4	REQ0#	Source Synch	Input/Output
K5	VSS	Power/Other	
K6	REQ3#	Source Synch	Input/Output
K7	VSS	Power/Other	
K8	VCC	Power/Other	
L1	LINT1	Asynch GTL+	Input
L2	TESTHI13	Asynch GTL+	Input
L23	VSS	Power/Other	
L24	VSS	Power/Other	
L25	VSS	Power/Other	
L26	VSS	Power/Other	
L27	VSS	Power/Other	
L28	VSS	Power/Other	
L29	VSS	Power/Other	
L3	VSS	Power/Other	
L30	VSS	Power/Other	
L4	A06#	Source Synch	Input/Output
L5	A03#	Source Synch	Input/Output
L6	VSS	Power/Other	
L7	VSS	Power/Other	
L8	VCC	Power/Other	
M1	VSS	Power/Other	
M2	THERMTRIP#	Asynch GTL+	Output
M23	VCC	Power/Other	
M24	VCC	Power/Other	
M25	VCC	Power/Other	
M26	VCC	Power/Other	
M27	VCC	Power/Other	
M28	VCC	Power/Other	

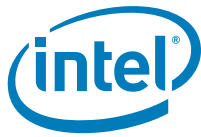


Table 24. Numerical Land Assignment

Land #	Land Name	Signal Buffer Type	Direction
M29	VCC	Power/Other	
M3	STPCLK#	Asynch GTL+	Input
M30	VCC	Power/Other	
M4	A07#	Source Synch	Input/Output
M5	A05#	Source Synch	Input/Output
M6	REQ2#	Source Synch	Input/Output
M7	VSS	Power/Other	
M8	VCC	Power/Other	
N1	PWRGOOD	Power/Other	Input
N2	IGNNE#	Asynch GTL+	Input
N23	VCC	Power/Other	
N24	VCC	Power/Other	
N25	VCC	Power/Other	
N26	VCC	Power/Other	
N27	VCC	Power/Other	
N28	VCC	Power/Other	
N29	VCC	Power/Other	
N3	VSS	Power/Other	
N30	VCC	Power/Other	
N4	RESERVED		
N5	RESERVED		
N6	VSS	Power/Other	
N7	VSS	Power/Other	
N8	VCC	Power/Other	
P1	TESTHI11	Power/Other	Input
P2	SMI#	Asynch GTL+	Input
P23	VSS	Power/Other	
P24	VSS	Power/Other	
P25	VSS	Power/Other	
P26	VSS	Power/Other	
P27	VSS	Power/Other	
P28	VSS	Power/Other	
P29	VSS	Power/Other	
P3	INIT#	Asynch GTL+	Input
P30	VSS	Power/Other	
P4	VSS	Power/Other	
P5	RESERVED		
P6	A04#	Source Synch	Input/Output
P7	VSS	Power/Other	
P8	VCC	Power/Other	

Table 24. Numerical Land Assignment

Land #	Land Name	Signal Buffer Type	Direction
R1	FC2	Power/Other	Input
R2	VSS	Power/Other	
R23	VSS	Power/Other	
R24	VSS	Power/Other	
R25	VSS	Power/Other	
R26	VSS	Power/Other	
R27	VSS	Power/Other	
R28	VSS	Power/Other	
R29	VSS	Power/Other	
R3	FERR#/PBE#	Asynch GTL+	Output
R30	VSS	Power/Other	
R4	A08#	Source Synch	Input/Output
R5	VSS	Power/Other	
R6	ADSTB0#	Source Synch	Input/Output
R7	VSS	Power/Other	
R8	VCC	Power/Other	
T1	COMP1	Power/Other	Input
T2	COMP5	Power/Other	Input
T23	VCC	Power/Other	
T24	VCC	Power/Other	
T25	VCC	Power/Other	
T26	VCC	Power/Other	
T27	VCC	Power/Other	
T28	VCC	Power/Other	
T29	VCC	Power/Other	
T3	VSS	Power/Other	
T30	VCC	Power/Other	
T4	A11#	Source Synch	Input/Output
T5	A09#	Source Synch	Input/Output
T6	VSS	Power/Other	
T7	VSS	Power/Other	
T8	VCC	Power/Other	
U1	VSS	Power/Other	
U2	AP0#	Common Clock	Input/Output
U23	VCC	Power/Other	
U24	VCC	Power/Other	
U25	VCC	Power/Other	
U26	VCC	Power/Other	
U27	VCC	Power/Other	
U28	VCC	Power/Other	

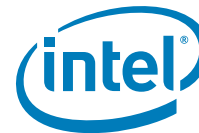


Table 24. Numerical Land Assignment

Land #	Land Name	Signal Buffer Type	Direction
U29	VCC	Power/Other	
U3	AP1#	Common Clock	Input/Output
U30	VCC	Power/Other	
U4	A13#	Source Synch	Input/Output
U5	A12#	Source Synch	Input/Output
U6	A10#	Source Synch	Input/Output
U7	VSS	Power/Other	
U8	VCC	Power/Other	
V1	MSID1	Power/Other	Output
V2	LL_ID0	Power/Other	Output
V23	VSS	Power/Other	
V24	VSS	Power/Other	
V25	VSS	Power/Other	
V26	VSS	Power/Other	
V27	VSS	Power/Other	
V28	VSS	Power/Other	
V29	VSS	Power/Other	
V3	VSS	Power/Other	
V30	VSS	Power/Other	
V4	A15#	Source Synch	Input/Output
V5	A14#	Source Synch	Input/Output
V6	VSS	Power/Other	
V7	VSS	Power/Other	
V8	VCC	Power/Other	
W1	MSID0	Power/Other	Output
W2	TESTHI12	Power/Other	Input
W23	VCC	Power/Other	
W24	VCC	Power/Other	
W25	VCC	Power/Other	
W26	VCC	Power/Other	
W27	VCC	Power/Other	
W28	VCC	Power/Other	
W29	VCC	Power/Other	
W3	TESTHI1	Power/Other	Input
W30	VCC	Power/Other	
W4	VSS	Power/Other	
W5	A16#	Source Synch	Input/Output

Table 24. Numerical Land Assignment

Land #	Land Name	Signal Buffer Type	Direction
W6	A18#	Source Synch	Input/Output
W7	VSS	Power/Other	
W8	VCC	Power/Other	
Y1	BOOTSELECT	Power/Other	Input
Y2	VSS	Power/Other	
Y23	VCC	Power/Other	
Y24	VCC	Power/Other	
Y25	VCC	Power/Other	
Y26	VCC	Power/Other	
Y27	VCC	Power/Other	
Y28	VCC	Power/Other	
Y29	VCC	Power/Other	
Y3	FC17	Power/Other	
Y30	VCC	Power/Other	
Y4	A20#	Source Synch	Input/Output
Y5	VSS	Power/Other	
Y6	A19#	Source Synch	Input/Output
Y7	VSS	Power/Other	
Y8	VCC	Power/Other	



4.2 Alphabetical Signals Reference

Table 25. Signal Description (Sheet 1 of 9)

Name	Type	Description												
A[35:3]#	Input/Output	<p>A[35:3]# (Address) define a 2³⁶-byte physical memory address space. In sub-phase 1 of the address phase, these signals transmit the address of a transaction. In sub-phase 2, these signals transmit transaction type information. These signals must connect the appropriate pins/lands of all agents on the processor FSB. A[35:3]# are protected by parity signals AP[1:0]#. A[35:3]# are source synchronous signals and are latched into the receiving buffers by ADSTB[1:0]#.</p> <p>On the active-to-inactive transition of RESET#, the processor samples a subset of the A[35:3]# signals to determine power-on configuration. See Section 6.1 for more details.</p>												
A20M#	Input	<p>If A20M# (Address-20 Mask) is asserted, the processor masks physical address bit 20 (A20#) before looking up a line in any internal cache and before driving a read/write transaction on the bus. Asserting A20M# emulates the 8086 processor's address wrap-around at the 1-MB boundary. Assertion of A20M# is only supported in real mode.</p> <p>A20M# is an asynchronous signal. However, to ensure recognition of this signal following an Input/Output write instruction, it must be valid along with the TRDY# assertion of the corresponding Input/Output Write bus transaction.</p>												
ADS#	Input/Output	<p>ADS# (Address Strobe) is asserted to indicate the validity of the transaction address on the A[35:3]# and REQ[4:0]# signals. All bus agents observe the ADS# activation to begin parity checking, protocol checking, address decode, internal snoop, or deferred reply ID match operations associated with the new transaction.</p>												
ADSTB[1:0]#	Input/Output	<p>Address strobes are used to latch A[35:3]# and REQ[4:0]# on their rising and falling edges. Strobes are associated with signals as shown below.</p> <table border="0"> <thead> <tr> <th style="text-align: left;">Signals</th> <th style="text-align: left;">Associated Strobe</th> </tr> </thead> <tbody> <tr> <td>REQ[4:0]#, A[16:3]#</td> <td>ADSTB0#</td> </tr> <tr> <td>A[35:17]#</td> <td>ADSTB1#</td> </tr> </tbody> </table>	Signals	Associated Strobe	REQ[4:0]#, A[16:3]#	ADSTB0#	A[35:17]#	ADSTB1#						
Signals	Associated Strobe													
REQ[4:0]#, A[16:3]#	ADSTB0#													
A[35:17]#	ADSTB1#													
AP[1:0]#	Input/Output	<p>AP[1:0]# (Address Parity) are driven by the request initiator along with ADS#, A[35:3]#, and the transaction type on the REQ[4:0]#. A correct parity signal is high if an even number of covered signals are low and low if an odd number of covered signals are low. This allows parity to be high when all the covered signals are high. AP[1:0]# should connect the appropriate pins/lands of all processor FSB agents. The following table defines the coverage model of these signals.</p> <table border="0"> <thead> <tr> <th style="text-align: left;">Request Signals</th> <th style="text-align: left;">Subphase 1</th> <th style="text-align: left;">Subphase 2</th> </tr> </thead> <tbody> <tr> <td>A[35:24]#</td> <td>AP0#</td> <td>AP1#</td> </tr> <tr> <td>A[23:3]#</td> <td>AP1#</td> <td>AP0#</td> </tr> <tr> <td>REQ[4:0]#</td> <td>AP1#</td> <td>AP0#</td> </tr> </tbody> </table>	Request Signals	Subphase 1	Subphase 2	A[35:24]#	AP0#	AP1#	A[23:3]#	AP1#	AP0#	REQ[4:0]#	AP1#	AP0#
Request Signals	Subphase 1	Subphase 2												
A[35:24]#	AP0#	AP1#												
A[23:3]#	AP1#	AP0#												
REQ[4:0]#	AP1#	AP0#												

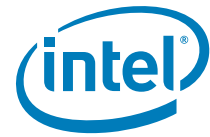


Table 25. Signal Description (Sheet 1 of 9)

Name	Type	Description
BCLK[1:0]	Input	The differential pair BCLK (Bus Clock) determines the FSB frequency. All processor FSB agents must receive these signals to drive their outputs and latch their inputs. All external timing parameters are specified with respect to the rising edge of BCLK0 crossing V_{CROSS} .
BINIT#	Input/ Output	BINIT# (Bus Initialization) may be observed and driven by all processor FSB agents and if used, must connect the appropriate pins/lands of all such agents. If the BINIT# driver is enabled during power-on configuration, BINIT# is asserted to signal any bus condition that prevents reliable future operation. If BINIT# observation is enabled during power-on configuration, and BINIT# is sampled asserted, symmetric agents reset their bus LOCK# activity and bus request arbitration state machines. The bus agents do not reset their IOQ and transaction tracking state machines upon observation of BINIT# activation. Once the BINIT# assertion has been observed, the bus agents will re-arbitrate for the FSB and attempt completion of their bus queue and IOQ entries. If BINIT# observation is disabled during power-on configuration, a central agent may handle an assertion of BINIT# as appropriate to the error handling architecture of the system.
BNR#	Input/ Output	BNR# (Block Next Request) is used to assert a bus stall by any bus agent unable to accept new bus transactions. During a bus stall, the current bus owner cannot issue any new transactions.
BOOTSELECT	Input	This input is required to determine whether the processor is installed in a platform that supports the Pentium 4 processor. The processor will not operate if this signal is low. This input has a weak internal pull-up to V_{CC} .
BPM[5:0]#	Input/ Output	BPM[5:0]# (Breakpoint Monitor) are breakpoint and performance monitor signals. They are outputs from the processor which indicate the status of breakpoints and programmable counters used for monitoring processor performance. BPM[5:0]# should connect the appropriate pins/lands of all processor FSB agents. BPM4# provides PRDY# (Probe Ready) functionality for the TAP port. PRDY# is a processor output used by debug tools to determine processor debug readiness. BPM5# provides PREQ# (Probe Request) functionality for the TAP port. PREQ# is used by debug tools to request debug operation of the processor. These signals do not have on-die termination. Refer to Section 2.5.2 for termination requirements.
BPRI#	Input	BPRI# (Bus Priority Request) is used to arbitrate for ownership of the processor FSB. It must connect the appropriate pins/lands of all processor FSB agents. Observing BPRI# active (as asserted by the priority agent) causes all other agents to stop issuing new requests, unless such requests are part of an ongoing locked operation. The priority agent keeps BPRI# asserted until all of its requests are completed, then releases the bus by de-asserting BPRI#.

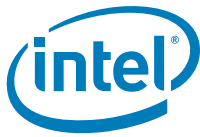


Table 25. Signal Description (Sheet 1 of 9)

Name	Type	Description															
BR0#	Input/Output	BR0# drives the BREQ0# signal in the system and is used by the processor to request the bus. During power-on configuration this signal is sampled to determine the agent ID = 0. This signal does not have on-die termination and must be terminated.															
BSEL[2:0]	Output	The BCLK[1:0] frequency select signals BSEL[2:0] are used to select the processor input clock frequency. Table 18 defines the possible combinations of the signals and the frequency associated with each combination. The required frequency is determined by the processor, chipset and clock synthesizer. All agents must operate at the same frequency. For more information about these signals, including termination recommendations, refer to Chapter 2.															
COMP[5:4,1:0]	Analog	COMP[1:0] must be terminated to V _{SS} on the system board using precision resistors. COMP[5:4] must be terminated to V _{TT} on the system board using precision resistors.															
D[63:0]#	Input/Output	<p>D[63:0]# (Data) are the data signals. These signals provide a 64-bit data path between the processor FSB agents, and must connect the appropriate pins/lands on all such agents. The data driver asserts DRDY# to indicate a valid data transfer.</p> <p>D[63:0]# are quad-pumped signals and will, thus, be driven four times in a common clock period. D[63:0]# are latched off the falling edge of both DSTBP[3:0]# and DSTBN[3:0]#. Each group of 16 data signals correspond to a pair of one DSTBP# and one DSTBN#. The following table shows the grouping of data signals to data strobes and DBI#.</p> <p>Quad-Pumped Signal Groups</p> <table border="1"> <thead> <tr> <th>Data Group</th> <th>DSTBN#/ DSTBP#</th> <th>DBI #</th> </tr> </thead> <tbody> <tr> <td>D[15:0]#</td> <td>0</td> <td>0</td> </tr> <tr> <td>D[31:16]#</td> <td>1</td> <td>1</td> </tr> <tr> <td>D[47:32]#</td> <td>2</td> <td>2</td> </tr> <tr> <td>D[63:48]#</td> <td>3</td> <td>3</td> </tr> </tbody> </table> <p>Furthermore, the DBI# signals determine the polarity of the data signals. Each group of 16 data signals corresponds to one DBI# signal. When the DBI# signal is active, the corresponding data group is inverted and therefore sampled active high.</p>	Data Group	DSTBN#/ DSTBP#	DBI #	D[15:0]#	0	0	D[31:16]#	1	1	D[47:32]#	2	2	D[63:48]#	3	3
Data Group	DSTBN#/ DSTBP#	DBI #															
D[15:0]#	0	0															
D[31:16]#	1	1															
D[47:32]#	2	2															
D[63:48]#	3	3															

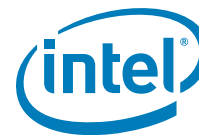


Table 25. Signal Description (Sheet 1 of 9)

Name	Type	Description										
DBI[3:0]#	Input/Output	<p>DBI[3:0]# (Data Bus Inversion) are source synchronous and indicate the polarity of the D[63:0]# signals. The DBI[3:0]# signals are activated when the data on the data bus is inverted. If more than half the data bits, within a 16-bit group, would have been asserted electrically low, the bus agent may invert the data bus signals for that particular sub-phase for that 16-bit group.</p> <p>DBI [3:0] Assignment To Data Bus</p> <table border="0"> <thead> <tr> <th>Bus Signal</th> <th>Data Bus Signals</th> </tr> </thead> <tbody> <tr> <td>DBI3#</td> <td>D[63:48]#</td> </tr> <tr> <td>DBI2#</td> <td>D[47:32]#</td> </tr> <tr> <td>DBI1#</td> <td>D[31:16]#</td> </tr> <tr> <td>DBI0#</td> <td>D[15:0]#</td> </tr> </tbody> </table>	Bus Signal	Data Bus Signals	DBI3#	D[63:48]#	DBI2#	D[47:32]#	DBI1#	D[31:16]#	DBI0#	D[15:0]#
Bus Signal	Data Bus Signals											
DBI3#	D[63:48]#											
DBI2#	D[47:32]#											
DBI1#	D[31:16]#											
DBI0#	D[15:0]#											
DBR#	Output	<p>DBR# (Debug Reset) is used only in processor systems where no debug port is implemented on the system board. DBR# is used by a debug port interposer so that an in-target probe can drive system reset. If a debug port is implemented in the system, DBR# is a no connect in the system. DBR# is not a processor signal.</p>										
DBSY#	Input/Output	<p>DBSY# (Data Bus Busy) is asserted by the agent responsible for driving data on the processor FSB to indicate that the data bus is in use. The data bus is released after DBSY# is de-asserted. This signal must connect the appropriate pins/lands on all processor FSB agents.</p>										
DEFER#	Input	<p>DEFER# is asserted by an agent to indicate that a transaction cannot be ensured in-order completion. Assertion of DEFER# is normally the responsibility of the addressed memory or input/output agent. This signal must connect the appropriate pins/lands of all processor FSB agents.</p>										
DP[3:0]#	Input/Output	<p>DP[3:0]# (Data parity) provide parity protection for the D[63:0]# signals. They are driven by the agent responsible for driving D[63:0]#, and must connect the appropriate pins/lands of all processor FSB agents.</p>										
DRDY#	Input/Output	<p>DRDY# (Data Ready) is asserted by the data driver on each data transfer, indicating valid data on the data bus. In a multi-common clock data transfer, DRDY# may be de-asserted to insert idle clocks. This signal must connect the appropriate pins/lands of all processor FSB agents.</p>										
DSTBN[3:0]#	Input/Output	<p>DSTBN[3:0]# are the data strobes used to latch in D[63:0]#.</p> <table border="0"> <thead> <tr> <th>Signals</th> <th>Associated Strobe</th> </tr> </thead> <tbody> <tr> <td>D[15:0]#, DBI0#</td> <td>DSTBN0#</td> </tr> <tr> <td>D[31:16]#, DBI1#</td> <td>DSTBN1#</td> </tr> <tr> <td>D[47:32]#, DBI2#</td> <td>DSTBN2#</td> </tr> <tr> <td>D[63:48]#, DBI3#</td> <td>DSTBN3#</td> </tr> </tbody> </table>	Signals	Associated Strobe	D[15:0]#, DBI0#	DSTBN0#	D[31:16]#, DBI1#	DSTBN1#	D[47:32]#, DBI2#	DSTBN2#	D[63:48]#, DBI3#	DSTBN3#
Signals	Associated Strobe											
D[15:0]#, DBI0#	DSTBN0#											
D[31:16]#, DBI1#	DSTBN1#											
D[47:32]#, DBI2#	DSTBN2#											
D[63:48]#, DBI3#	DSTBN3#											

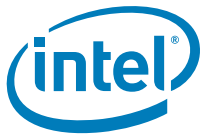


Table 25. Signal Description (Sheet 1 of 9)

Name	Type	Description										
DSTBP[3:0]#	Input/Output	<p>DSTBP[3:0]# are the data strobes used to latch in D[63:0]#.</p> <table border="1"> <thead> <tr> <th>Signals</th> <th>Associated Strobe</th> </tr> </thead> <tbody> <tr> <td>D[15:0]#, DBI0#</td> <td>DSTBP0#</td> </tr> <tr> <td>D[31:16]#, DBI1#</td> <td>DSTBP1#</td> </tr> <tr> <td>D[47:32]#, DBI2#</td> <td>DSTBP2#</td> </tr> <tr> <td>D[63:48]#, DBI3#</td> <td>DSTBP3#</td> </tr> </tbody> </table>	Signals	Associated Strobe	D[15:0]#, DBI0#	DSTBP0#	D[31:16]#, DBI1#	DSTBP1#	D[47:32]#, DBI2#	DSTBP2#	D[63:48]#, DBI3#	DSTBP3#
Signals	Associated Strobe											
D[15:0]#, DBI0#	DSTBP0#											
D[31:16]#, DBI1#	DSTBP1#											
D[47:32]#, DBI2#	DSTBP2#											
D[63:48]#, DBI3#	DSTBP3#											
FCx	Other	FC signals are signals that are available for compatibility with other processors.										
FERR#/PBE#	Output	FERR#/PBE# (floating point error/pending break event) is a multiplexed signal and its meaning is qualified by STPCLK#. When STPCLK# is not asserted, FERR#/PBE# indicates a floating-point error and will be asserted when the processor detects an unmasked floating-point error. When STPCLK# is not asserted, FERR#/PBE# is similar to the ERROR# signal on the Intel 387 coprocessor, and is included for compatibility with systems using MS-DOS* -type floating-point error reporting. When STPCLK# is asserted, an assertion of FERR#/PBE# indicates that the processor has a pending break event waiting for service. The assertion of FERR#/PBE# indicates that the processor should be returned to the Normal state. For additional information on the pending break event functionality, including the identification of support of the feature and enable/disable information, refer to volume 3 of the <i>Intel® 64 and IA-32 Architecture Software Developer's Manual</i> and the <i>Intel Processor Identification and the CPUID Instruction</i> application note.										
GTLREF[1:0]	Input	GTLREF[1:0] determine the signal reference level for GTL+ input signals. GTLREF is used by the GTL+ receivers to determine if a signal is a logical 0 or logical 1.										
HIT# HITM#	Input/Output Input/Output	HIT# (Snoop Hit) and HITM# (Hit Modified) convey transaction snoop operation results. Any FSB agent may assert both HIT# and HITM# together to indicate that it requires a snoop stall, which can be continued by reasserting HIT# and HITM# together.										
IERR#	Output	<p>IERR# (Internal Error) is asserted by a processor as the result of an internal error. Assertion of IERR# is usually accompanied by a SHUTDOWN transaction on the processor FSB. This transaction may optionally be converted to an external error signal (e.g., NMI) by system core logic. The processor will keep IERR# asserted until the assertion of RESET#.</p> <p>This signal does not have on-die termination. Refer to Section 2.5.2 for termination requirements.</p>										

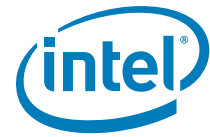


Table 25. Signal Description (Sheet 1 of 9)

Name	Type	Description
IGNNE#	Input	IGNNE# (Ignore Numeric Error) is asserted to the processor to ignore a numeric error and continue to execute noncontrol floating-point instructions. If IGNNE# is de-asserted, the processor generates an exception on a noncontrol floating-point instruction if a previous floating-point instruction caused an error. IGNNE# has no effect when the NE bit in control register 0 (CR0) is set. IGNNE# is an asynchronous signal. However, to ensure recognition of this signal following an Input/Output write instruction, it must be valid along with the TRDY# assertion of the corresponding Input/Output Write bus transaction.
IMPSEL	Input	IMPSEL input will determine whether the processor uses a 50 Ω or 60 Ω buffer. This pin must be tied to GND on 50 Ω platforms and left as NC on 60 Ω platforms.
INIT#	Input	INIT# (Initialization), when asserted, resets integer registers inside the processor without affecting its internal caches or floating-point registers. The processor then begins execution at the power-on Reset vector configured during power-on configuration. The processor continues to handle snoop requests during INIT# assertion. INIT# is an asynchronous signal and must connect the appropriate pins/lands of all processor FSB agents. If INIT# is sampled active on the active to inactive transition of RESET#, then the processor executes its Built-in Self-Test (BIST).
ITP_CLK[1:0]	Input	ITP_CLK[1:0] are copies of BCLK that are used only in processor systems where no debug port is implemented on the system board. ITP_CLK[1:0] are used as BCLK[1:0] references for a debug port implemented on an interposer. If a debug port is implemented in the system, ITP_CLK[1:0] are no connects in the system. These are not processor signals.
LINT[1:0]	Input	LINT[1:0] (Local APIC Interrupt) must connect the appropriate pins/lands of all APIC Bus agents. When the APIC is disabled, the LINT0 signal becomes INTR, a maskable interrupt request signal, and LINT1 becomes NMI, a nonmaskable interrupt. INTR and NMI are backward compatible with the signals of those names on the Pentium processor. Both signals are asynchronous. Both of these signals must be software configured via BIOS programming of the APIC register space to be used either as NMI/INTR or LINT[1:0]. Because the APIC is enabled by default after Reset, operation of these signals as LINT[1:0] is the default configuration.
LL_ID[1:0]	Output	The LL_ID[1:0] signals are used to select the correct loadline slope for the processor. LL_ID[1:0] = 00 for the Pentium 4 processor.
LOCK#	Input/Output	LOCK# indicates to the system that a transaction must occur atomically. This signal must connect the appropriate pins/lands of all processor FSB agents. For a locked sequence of transactions, LOCK# is asserted from the beginning of the first transaction to the end of the last transaction. When the priority agent asserts BPRI# to arbitrate for ownership of the processor FSB, it will wait until it observes LOCK# de-asserted. This enables symmetric agents to retain ownership of the processor FSB throughout the bus locked operation and ensure the atomicity of lock.

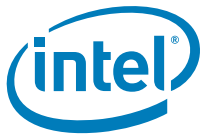


Table 25. Signal Description (Sheet 1 of 9)

Name	Type	Description
MCERR#	Input/Output	<p>MCERR# (Machine Check Error) is asserted to indicate an unrecoverable error without a bus protocol violation. It may be driven by all processor FSB agents.</p> <p>MCERR# assertion conditions are configurable at a system level. Assertion options are defined by the following options:</p> <ul style="list-style-type: none"> • Enabled or disabled. • Asserted, if configured, for internal errors along with IERR#. • Asserted, if configured, by the request initiator of a bus transaction after it observes an error. • Asserted by any bus agent when it observes an error in a bus transaction. <p>For more details regarding machine check architecture, refer to the <i>Intel® 64 and IA-32 Architecture Software Developer's Manual, Volume 3: System Programming Guide</i>.</p>
MSID[1:0]	Input	<p>MSID[1:0] (input) MSID0 is used to indicate to the processor whether the platform supports 775_VR_CONFIG_05B processors. A 775_VR_CONFIG_05B processor will only boot if it's MSID0 pin is electrically low. A 775_VR_CONFIG_05A processor will ignore this input.</p> <p>MSID1 must be electrically low for the processor to boot.</p>
PROCHOT#	Input/Output	<p>As an output, PROCHOT# (Processor Hot) will go active when the processor temperature monitoring sensor detects that the processor has reached its maximum safe operating temperature. This indicates that the processor Thermal Control Circuit (TCC) has been activated, if enabled. As an input, assertion of PROCHOT# by the system will activate the TCC, if enabled. The TCC will remain active until the system de-asserts PROCHOT#. See Section 5.2.4 for more details.</p>
PWRGOOD	Input	<p>PWRGOOD (Power Good) is a processor input. The processor requires this signal to be a clean indication that the clocks and power supplies are stable and within their specifications. 'Clean' implies that the signal will remain low (capable of sinking leakage current), without glitches, from the time that the power supplies are turned on until they come within specification. The signal must then transition monotonically to a high state. PWRGOOD can be driven inactive at any time, but clocks and power must again be stable before a subsequent rising edge of PWRGOOD.</p> <p>The PWRGOOD signal must be supplied to the processor; it is used to protect internal circuits against voltage sequencing issues. It should be driven high throughout boundary scan operation.</p>
REQ[4:0]#	Input/Output	<p>REQ[4:0]# (Request Command) must connect the appropriate pins/lands of all processor FSB agents. They are asserted by the current bus owner to define the currently active transaction type. These signals are source synchronous to ADSTB0#. Refer to the AP[1:0]# signal description for a details on parity checking of these signals.</p>

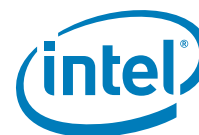


Table 25. Signal Description (Sheet 1 of 9)

Name	Type	Description
RESET#	Input	Asserting the RESET# signal resets the processor to a known state and invalidates its internal caches without writing back any of their contents. For a power-on Reset, RESET# must stay active for at least one millisecond after V _{CC} and BCLK have reached their proper specifications. On observing active RESET#, all FSB agents will de-assert their outputs within two clocks. RESET# must not be kept asserted for more than 10 ms while PWRGOOD is asserted. A number of bus signals are sampled at the active-to-inactive transition of RESET# for power-on configuration. These configuration options are described in the Section 6.1 . This signal does not have on-die termination and must be terminated on the system board.
RS[2:0]#	Input	RS[2:0]# (Response Status) are driven by the response agent (the agent responsible for completion of the current transaction), and must connect the appropriate pins/lands of all processor FSB agents.
RSP#	Input	RSP# (Response Parity) is driven by the response agent (the agent responsible for completion of the current transaction) during assertion of RS[2:0]#, the signals for which RSP# provides parity protection. It must connect to the appropriate pins/lands of all processor FSB agents. A correct parity signal is high if an even number of covered signals are low and low if an odd number of covered signals are low. While RS[2:0]# = 000, RSP# is also high, since this indicates it is not being driven by any agent ensuring correct parity.
SKTOCC#	Output	SKTOCC# (Socket Occupied) will be pulled to ground by the processor. System board designers may use this signal to determine if the processor is present.
SMI#	Input	SMI# (System Management Interrupt) is asserted asynchronously by system logic. On accepting a System Management Interrupt, the processor saves the current state and enter System Management Mode (SMM). An SMI Acknowledge transaction is issued, and the processor begins program execution from the SMM handler. If SMI# is asserted during the de-assertion of RESET#, the processor will tri-state its outputs.
STPCLK#	Input	STPCLK# (Stop Clock), when asserted, causes the processor to enter a low power Stop-Grant state. The processor issues a Stop-Grant Acknowledge transaction, and stops providing internal clock signals to all processor core units except the FSB and APIC units. The processor continues to snoop bus transactions and service interrupts while in Stop-Grant state. When STPCLK# is de-asserted, the processor restarts its internal clock to all units and resumes execution. The assertion of STPCLK# has no effect on the bus clock; STPCLK# is an asynchronous input.
TCK	Input	TCK (Test Clock) provides the clock input for the processor Test Bus (also known as the Test Access Port).
TDI	Input	TDI (Test Data In) transfers serial test data into the processor. TDI provides the serial input needed for JTAG specification support.
TDO	Output	TDO (Test Data Out) transfers serial test data out of the processor. TDO provides the serial output needed for JTAG specification support.

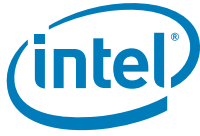


Table 25. Signal Description (Sheet 1 of 9)

Name	Type	Description
TESTHI[13:0]	Input	TESTHI[13:0] must be connected to the processor's appropriate power source (refer to VTT_OUT_LEFT and VTT_OUT_RIGHT signal description) through a resistor for proper processor operation. See Section 2.4 for more details.
THERMDA	Other	Thermal Diode Anode. See Section 5.2.7.
THERMDC	Other	Thermal Diode Cathode. See Section 5.2.7.
THERMTRIP#	Output	In the event of a catastrophic cooling failure, the processor will automatically shut down when the silicon has reached a temperature approximately 20 °C above the maximum T_C . Assertion of THERMTRIP# (Thermal Trip) indicates the processor junction temperature has reached a level beyond where permanent silicon damage may occur. Upon assertion of THERMTRIP#, the processor will shut off its internal clocks (thus, halting program execution) in an attempt to reduce the processor junction temperature. To protect the processor, its core voltage (V_{CC}) must be removed following the assertion of THERMTRIP#. Driving of the THERMTRIP# signal is enabled within 10 μ s of the assertion of PWRGOOD (provided VTPWRGD, V_{TT} , and V_{CC} are asserted) and is disabled on de-assertion of PWRGOOD (if VTPWRGD, V_{TT} , or V_{CC} are not valid, THERMTRIP# may also be disabled). Once activated, THERMTRIP# remains latched until PWRGOOD, VTPWRGD, V_{TT} or V_{CC} is de-asserted. While the de-assertion of the PWRGOOD, VTPWRGD, VTT or VCC signal will de-assert THERMTRIP#, if the processor's junction temperature remains at or above the trip level, THERMTRIP# will again be asserted within 10 μ s of the assertion of PWRGOOD (provided VTPWRGD, V_{TT} , and V_{CC} are asserted).
TMS	Input	TMS (Test Mode Select) is a JTAG specification support signal used by debug tools.
TRDY#	Input	TRDY# (Target Ready) is asserted by the target to indicate that it is ready to receive a write or implicit writeback data transfer. TRDY# must connect the appropriate pins/lands of all FSB agents.
TRST#	Input	TRST# (Test Reset) resets the Test Access Port (TAP) logic. TRST# must be driven low during power on Reset.
VCC	Input	VCC are the power lands for the processor. The voltage supplied to these lands is determined by the VID[5:0] pins.
VCCA	Input	VCCA provides isolated power for the internal processor core PLLs.
VCCIOPLL	Input	VCCIOPLL provides isolated power for internal processor FSB PLLs.
VCC_SENSE	Output	VCC_SENSE is an isolated low impedance connection to processor core power (V_{CC}). It can be used to sense or measure voltage near the silicon with little noise.
VCC_MB_REGULATION	Output	This land is provided as a voltage regulator feedback sense point for V_{CC} . It is connected internally in the processor package to the sense point land U27 as described in the <i>Voltage Regulator-Down (VRD) 10.1 Design Guide for Desktop Socket 775</i> .

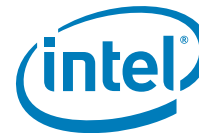
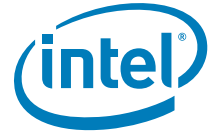


Table 25. Signal Description (Sheet 1 of 9)

Name	Type	Description
VID[5:0]	Output	VID[5:0] (Voltage ID) signals are used to support automatic selection of power supply voltages (V_{CC}). Refer to the <i>Voltage Regulator-Down (VRD) 10.1 Design Guide for Desktop Socket 775</i> for more information. The voltage supply for these signals must be valid before the VR can supply V_{CC} to the processor. Conversely, the VR output must be disabled until the voltage supply for the VID signals becomes valid. The VID signals are needed to support the processor voltage specification variations. See Table 2 for definitions of these signals. The VR must supply the voltage that is requested by the signals, or disable itself.
VSS	Input	VSS are the ground pins for the processor and should be connected to the system ground plane.
VSSA	Input	VSSA is the isolated ground for internal PLLs.
VSS_SENSE	Output	VSS_SENSE is an isolated low impedance connection to processor core V_{SS} . It can be used to sense or measure ground near the silicon with little noise.
VSS_MB_REGULATION	Output	This land is provided as a voltage regulator feedback sense point for V_{SS} . It is connected internally in the processor package to the sense point land V27 as described in the <i>Voltage Regulator-Down (VRD) 10.1 Design Guide for Desktop Socket 775</i> .
VTT		Miscellaneous voltage supply.
VTT_OUT_LEFT VTT_OUT_RIGHT	Output	The VTT_OUT_LEFT and VTT_OUT_RIGHT signals are included to provide a voltage supply for some signals that require termination to V_{TT} on the motherboard.
VTT_SEL	Output	The VTT_SEL signal is used to select the correct V_{TT} voltage level for the processor. This land is connected internally in the package to V_{TT} .
VTPWRGD	Input	The processor requires this input to determine that the V_{TT} voltages are stable and within specification.

§ §





5 Thermal Specifications and Design Considerations

5.1 Processor Thermal Specifications

The Pentium 4 processor requires a thermal solution to maintain temperatures within the operating limits as set forth in [Section 5.1.1](#). Any attempt to operate the processor outside these operating limits may result in permanent damage to the processor and potentially other components within the system. As processor technology changes, thermal management becomes increasingly crucial when building computer systems. Maintaining the proper thermal environment is key to reliable, long-term system operation.

A complete thermal solution includes both component and system level thermal management features. Component level thermal solutions can include active or passive heatsinks attached to the processor Integrated Heat Spreader (IHS). Typical system level thermal solutions may consist of system fans combined with ducting and venting.

For more information on designing a component level thermal solution, refer to the appropriate processor Thermal and Mechanical Design Guidelines (see [Section 1.2](#)).

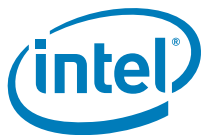
Note: The boxed processor will ship with a component thermal solution. Refer to [Chapter 7](#) for details on the boxed processor.

5.1.1 Thermal Specifications

To allow for the optimal operation and long-term reliability of Intel processor-based systems, the system/processor thermal solution should be designed such that the processor remains within the minimum and maximum case temperature (T_C) specifications when operating at or below the Thermal Design Power (TDP) value listed per frequency in [Table 26](#). Thermal solutions not designed to provide this level of thermal capability may affect the long-term reliability of the processor and system. For more details on thermal solution design, refer to the appropriate processor Thermal and Mechanical Design Guidelines (see [Section 1.2](#)).

The Pentium 4 processor uses a methodology for managing processor temperatures that is intended to support acoustic noise reduction through fan speed control. Selection of the appropriate fan speed will be based on the temperature reported by the processor's Thermal Diode. If the diode temperature is greater than or equal to $T_{CONTROL}$, then the processor case temperature must remain at or below the temperature as specified by the thermal profile. If the diode temperature is less than $T_{CONTROL}$, then the case temperature is permitted to exceed the thermal profile; but the diode temperature must remain at or below $T_{CONTROL}$. Systems that implement fan speed control must be designed to take these conditions into account. Systems that do not alter the fan speed only need to ensure the case temperature meets the thermal profile specifications.

To determine a processor's case temperature specification based on the thermal profile, it is necessary to accurately measure processor power dissipation. Intel has developed a methodology for accurate power measurement that correlates to Intel test temperature and voltage conditions. Refer to the appropriate processor Thermal and Mechanical Design Guidelines (see [Section 1.2](#)) and the *Processor Power Characterization Methodology* for the details of this methodology.



The case temperature is defined at the geometric top center of the processor. Analysis indicates that real applications are unlikely to cause the processor to consume maximum power dissipation for sustained time periods. Intel recommends that complete thermal solution designs target the Thermal Design Power (TDP) indicated in [Table 26](#) instead of the maximum processor power consumption. The Thermal Monitor feature is designed to protect the processor in the unlikely event that an application exceeds the TDP recommendation for a sustained periods of time. For more details on the usage of this feature, refer to [Section 5.2](#). **In all cases the Thermal Monitor or Thermal Monitor 2 feature must be enabled for the processor to remain within specification.**

Table 26. Processor Thermal Specifications for 775_VR_CONFIG_05A Processors

Processor Number	Core Frequency (GHz)	Thermal Design Power (W)	Minimum T _C (°C)	Maximum T _C (°C)	Notes
631	3 GHz	86	5	See Table 28 and Figure 12	1, 2
641	3.20 GHz	86	5	See Table 28 and Figure 12	1, 2
651	3.40 GHz	86	5	See Table 28 and Figure 12	1, 2
661	3.60 GHz	86	5	See Table 28 and Figure 12	1, 2

NOTES:

1. Thermal Design Power (TDP) should be used for processor thermal solution design targets. The TDP is not the maximum power that the processor can dissipate.
2. This table shows the maximum TDP for a given frequency range. Individual processors may have a lower TDP. Therefore, the maximum T_C will vary depending on the TDP of the individual processor. Refer to [Table 28](#) and [Figure 12](#) for the allowed combinations of power and T_C.

Table 27. Processor Thermal Specifications for 775_VR_CONFIG_06 Processors

Processor Number	Core Frequency (GHz)	Thermal Design Power (W)	Minimum T _C (°C)	Maximum T _C (°C)	Notes
631	3 GHz	65	5	See Table 29 and Figure 13	1, 2
641	3.20 GHz	65	5		
651	3.40 GHz	65	5		

NOTES:

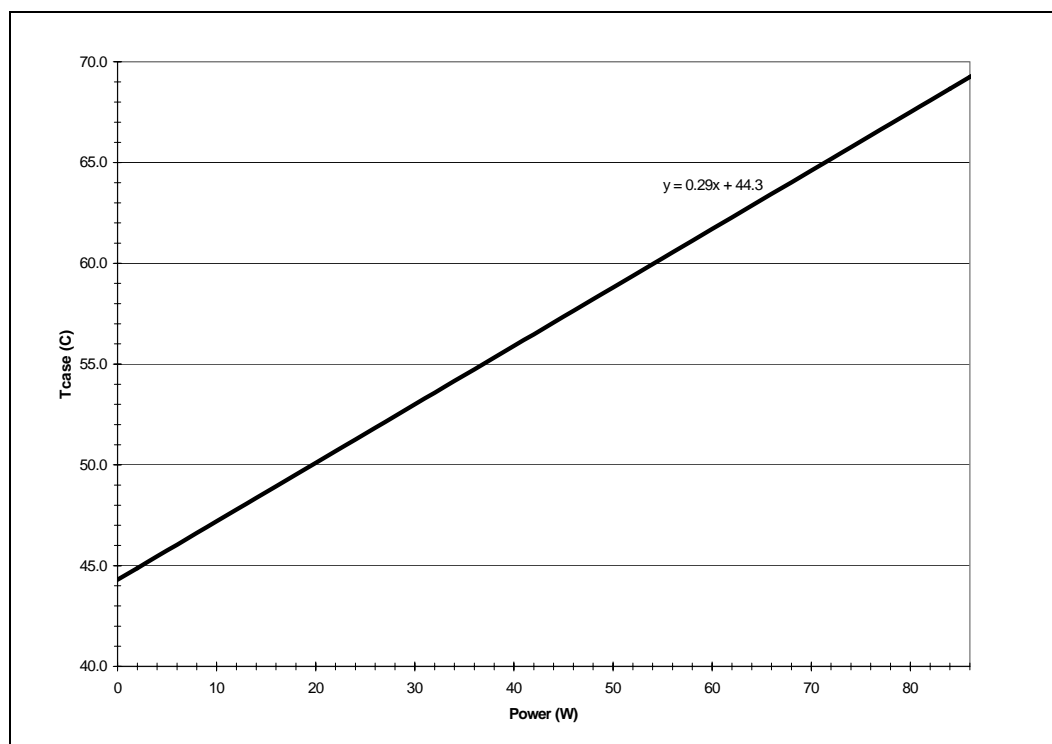
1. Thermal Design Power (TDP) should be used for processor thermal solution design targets. The TDP is not the maximum power that the processor can dissipate.
2. This table shows the maximum TDP for a given frequency range. Individual processors may have a lower TDP. Therefore, the maximum T_C will vary depending on the TDP of the individual processor. Refer to thermal profile figure and associated table for the allowed combinations of power and T_C.



Table 28. Thermal Profile for 775_VR_CONFIG_05A Processors

Power (W)	Maximum T _C (°C)	Power (W)	Maximum T _C (°C)	Power (W)	Maximum T _C (°C)
0	44.3	30	53.0	60	61.7
2	44.9	32	53.6	62	62.3
4	45.5	34	54.2	64	62.9
6	46.0	36	54.7	66	63.4
8	46.6	38	55.3	68	64.0
10	47.2	40	55.9	70	64.6
12	47.8	42	56.5	72	65.2
14	48.4	44	57.1	74	65.8
16	48.9	46	57.6	76	66.3
18	49.5	48	58.2	78	66.9
20	50.1	50	58.8	80	67.5
22	50.7	52	59.4	82	68.1
24	51.3	54	60.0	84	68.7
26	51.8	56	60.5	86	69.2
28	52.4	58	61.1		

Figure 12. Thermal Profile for 775_VR_CONFIG_05A Processors



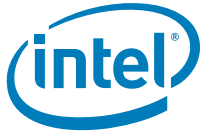
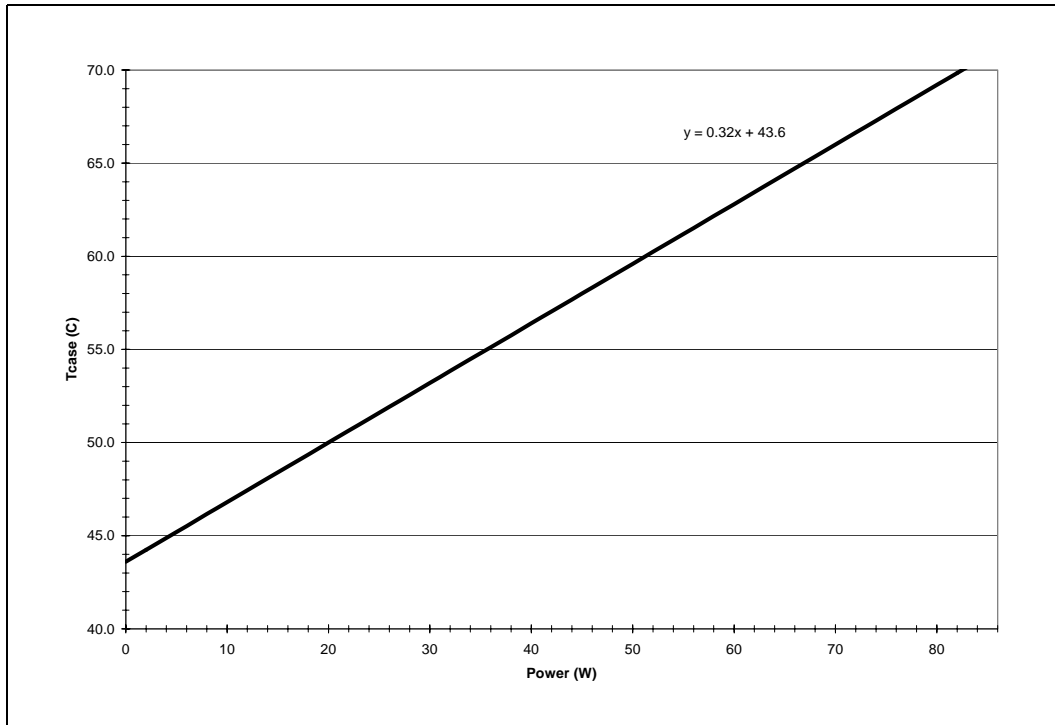
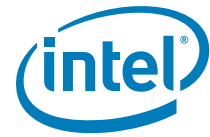


Table 29. Thermal Profile for 775_VR_CONFIG_06 Processors

Power (W)	Maximum Tc (°C)	Power (W)	Maximum Tc (°C)
0	43.6	34	54.5
2	44.2	36	55.1
4	44.9	38	55.8
6	45.5	40	56.4
8	46.2	42	57.0
10	46.8	44	57.7
12	47.4	46	58.3
14	48.1	48	59.0
16	48.7	50	59.6
18	49.4	52	60.2
20	50.0	54	60.9
22	50.6	56	61.5
24	51.3	58	62.2
26	51.9	60	62.8
28	52.6	62	63.4
30	53.2	64	64.1
32	53.8		

Figure 13. Thermal Profile for 775_VR_CONFIG_06 Processors

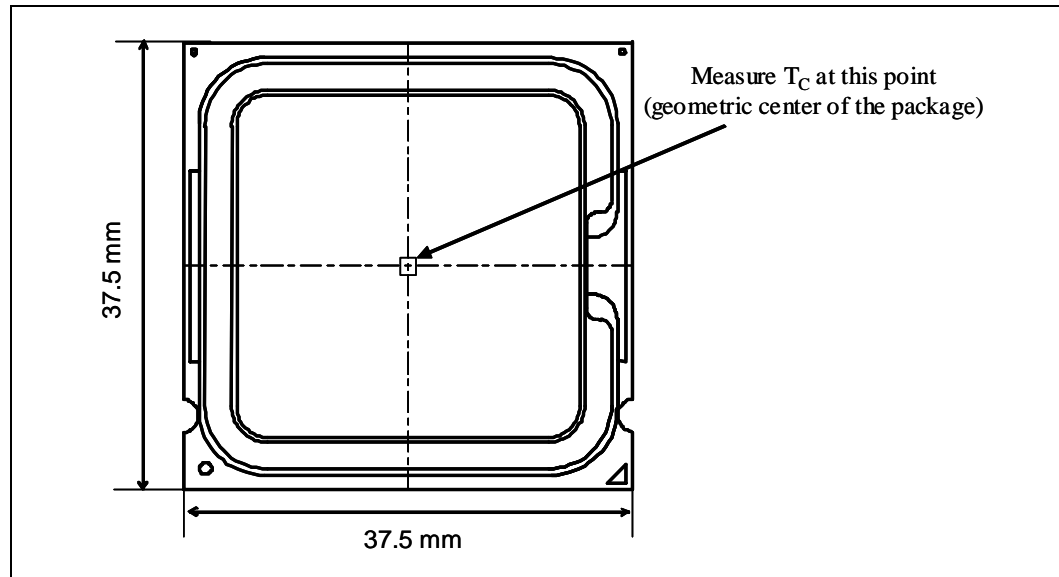




5.1.2 Thermal Metrology

The maximum and minimum case temperatures (T_C) for the processor is specified in Table 26. This temperature specification is meant to help ensure proper operation of the processor. Figure 14 illustrates where Intel recommends T_C thermal measurements should be made. For detailed guidelines on temperature measurement methodology, refer to the appropriate processor Thermal and Mechanical Design Guidelines (see Section 1.2).

Figure 14. Case Temperature (T_C) Measurement Location

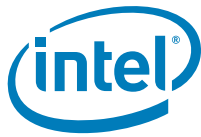


5.2 Processor Thermal Features

5.2.1 Thermal Monitor

The Thermal Monitor feature helps control the processor temperature by activating the thermal control circuit (TCC) when the processor silicon reaches its maximum operating temperature. The TCC reduces processor power consumption by modulating (starting and stopping) the internal processor core clocks. **The Thermal Monitor feature must be enabled for the processor to be operating within specifications.** The temperature at which Thermal Monitor activates the thermal control circuit is not user configurable and is not software visible. Bus traffic is snooped in the normal manner, and interrupt requests are latched (and serviced during the time that the clocks are on) while the TCC is active.

When the Thermal Monitor feature is enabled and a high temperature situation exists (i.e., TCC is active), the clocks will be modulated by alternately turning the clocks off and on at a duty cycle specific to the processor (typically 30–50%). Clocks often will not be off for more than 3.0 microseconds when the TCC is active. Cycle times are processor speed dependent and decrease as processor core frequencies increase. A small amount of hysteresis has been included to prevent rapid active/inactive transitions of the TCC when the processor temperature is near its maximum operating temperature. Once the temperature has dropped below the maximum operating temperature and the hysteresis timer has expired, the TCC goes inactive and clock modulation ceases.



With a properly designed and characterized thermal solution, it is anticipated that the TCC would only be activated for very short periods of time when running the most power intensive applications. The processor performance impact due to these brief periods of TCC activation is expected to be so minor that it would be immeasurable. An under-designed thermal solution that is not able to prevent excessive activation of the TCC in the anticipated ambient environment may cause a noticeable performance loss, and in some cases may result in a T_C that exceeds the specified maximum temperature; this may affect the long-term reliability of the processor. In addition, a thermal solution that is significantly under-designed may not be capable of cooling the processor even when the TCC is active continuously. Refer to the appropriate processor Thermal and Mechanical Design Guidelines (see [Section 1.2](#)) for information on designing a thermal solution.

The duty cycle for the TCC, when activated by the Thermal Monitor, is factory configured and cannot be modified. The Thermal Monitor does not require any additional hardware, software drivers, or interrupt handling routines.

5.2.2 Thermal Monitor 2

The Pentium 4 processor also supports an additional power reduction capability known as Thermal Monitor 2. This mechanism provides an efficient means for limiting the processor temperature by reducing the power consumption within the processor.

When Thermal Monitor 2 is enabled, and a high temperature situation is detected, the Thermal Control Circuit (TCC) will be activated. The TCC causes the processor to adjust its operating frequency (via the bus multiplier) and input voltage (via the VID signals). This combination of reduced frequency and VID results in a reduction to the processor power consumption.

A processor enabled for Thermal Monitor 2 includes two operating points, each consisting of a specific operating frequency and voltage. The first operating point represents the normal operating condition for the processor. Under this condition, the core-frequency-to-FSB multiple used by the processor is that contained in the IA32_PERF_STS MSR and the VID is the one specified in [Table 4](#). These parameters represent normal system operation.

The second operating point consists of both a lower operating frequency and voltage. When the TCC is activated, the processor automatically transitions to the new frequency. This transition occurs very rapidly (on the order of 5 μ s). During the frequency transition, the processor is unable to service any bus requests, and consequently, all bus traffic is blocked. Edge-triggered interrupts are latched and kept pending until the processor resumes operation at the new frequency.

Once the new operating frequency is engaged, the processor will transition to the new core operating voltage by issuing a new VID code to the voltage regulator. The voltage regulator must support dynamic VID steps in order to support Thermal Monitor 2. During the voltage change, it will be necessary to transition through multiple VID codes to reach the target operating voltage. Each step will likely be one VID table entry (see [Table 4](#)). The processor continues to execute instructions during the voltage transition. Operation at the lower voltage reduces the power consumption of the processor.

A small amount of hysteresis has been included to prevent rapid active/inactive transitions of the TCC when the processor temperature is near its maximum operating temperature. Once the temperature has dropped below the maximum operating temperature, and the hysteresis timer has expired, the operating frequency and voltage transition back to the normal system operating point. Transition of the VID code will occur first, in order to insure proper operation once the processor reaches its normal operating frequency. Refer to [Figure 15](#) for an illustration of this ordering.

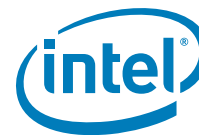
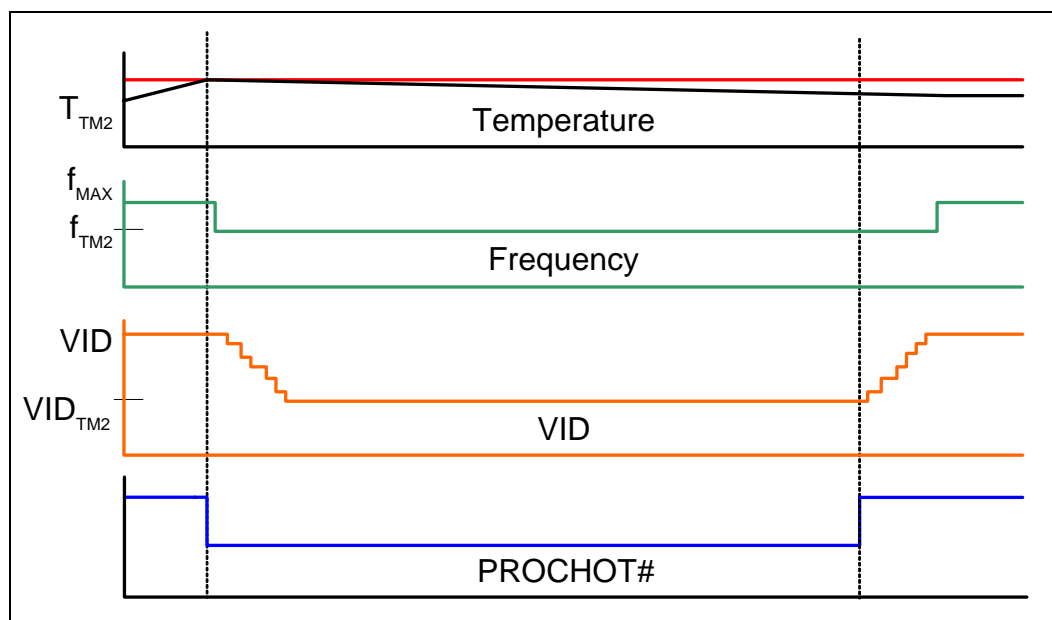


Figure 15. Thermal Monitor 2 Frequency and Voltage Ordering



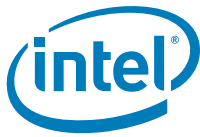
The PROCHOT# signal is asserted when a high temperature situation is detected, regardless of whether Thermal Monitor or Thermal Monitor 2 is enabled.

Note that the Thermal Monitor 2 TCC cannot be activated via the on demand mode. The Thermal Monitor TCC, however, can be activated through the use of the on demand mode.

5.2.3 On-Demand Mode

The processor provides an auxiliary mechanism that allows system software to force the processor to reduce its power consumption. This mechanism is referred to as “On-Demand” mode and is distinct from the Thermal Monitor feature. On-Demand mode is intended as a means to reduce system level power consumption. Systems using the Pentium 4 processor must not rely on software usage of this mechanism to limit the processor temperature.

If bit 4 of the ACPI P_CNT Control Register (located in the processor IA32_THERM_CONTROL MSR) is written to a '1', the processor immediately reduces its power consumption via modulation (starting and stopping) of the internal core clock, independent of the processor temperature. When using On-Demand mode, the duty cycle of the clock modulation is programmable via bits 3:1 of the same ACPI P_CNT Control Register. In On-Demand mode, the duty cycle can be programmed from 12.5% on/87.5% off, to 87.5% on/12.5% off in 12.5% increments. On-Demand mode may be used in conjunction with the Thermal Monitor. If the system tries to enable On-Demand mode at the same time the TCC is engaged, the factory configured duty cycle of the TCC will override the duty cycle selected by the On-Demand mode.



5.2.4 PROCHOT# Signal

An external signal, PROCHOT# (processor hot), is asserted when the processor die temperature has reached its maximum operating temperature. If the Thermal Monitor is enabled (note that the Thermal Monitor must be enabled for the processor to be operating within specification), the TCC will be active when PROCHOT# is asserted. The processor can be configured to generate an interrupt upon the assertion or de-assertion of PROCHOT#. Refer to the *Intel® 64 and IA-32 Architecture Software Developer's Manuals* for specific register and programming details.

The processor implements a bi-directional PROCHOT# capability to allow system designs to protect various components from over-temperature situations. The PROCHOT# signal is bi-directional in that it can either signal when the processor has reached its maximum operating temperature or be driven from an external source to activate the TCC. The ability to activate the TCC via PROCHOT# can provide a means for thermal protection of system components.

One application is the thermal protection of voltage regulators (VR). System designers can create a circuit to monitor the VR temperature and activate the TCC when the temperature limit of the VR is reached. By asserting PROCHOT# (pulled-low) and activating the TCC, the VR can cool down as a result of reduced processor power consumption. Bi-directional PROCHOT# can allow VR thermal designs to target maximum sustained current instead of maximum current. Systems should still provide proper cooling for the VR, and rely on bi-directional PROCHOT# only as a backup in case of system cooling failure. Refer to the *Voltage Regulator-Down (VRD) 10.1 Design Guide For Desktop and Transportable LGA775 Socket* for details on implementing the bi-directional PROCHOT# feature.

5.2.5 THERMTRIP# Signal

Regardless of whether or not Thermal Monitor or Thermal Monitor 2 is enabled, in the event of a catastrophic cooling failure, the processor will automatically shut down when the silicon has reached an elevated temperature (refer to the THERMTRIP# definition in [Table 25](#)). At this point, the FSB signal THERMTRIP# will go active and stay active as described in [Table 25](#). THERMTRIP# activation is independent of processor activity and does not generate any bus cycles.

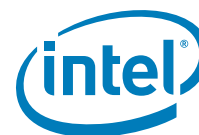
5.2.6 T_{CONTROL} and Fan Speed Reduction

T_{CONTROL} is a temperature specification based on a temperature reading from the thermal diode. The value for T_{CONTROL} will be calibrated in manufacturing and configured for each processor. When T_{DIODE} is above T_{CONTROL}, T_C must be at or below T_{C-MAX} as defined by the thermal profile in [Table 28](#) and [Figure 12](#); otherwise, the processor temperature can be maintained at T_{CONTROL} (or lower) as measured by the thermal diode.

The purpose of this feature is to support acoustic optimization through fan speed control. Contact your Intel representative for further details and documentation.

5.2.7 Thermal Diode

The processor incorporates an on-die PNP transistor whose base emitter junction is used as a thermal "diode", with its collector shorted to Ground. A thermal sensor located on the system board may monitor the die temperature of the processor for thermal management and fan speed control. [Table 30](#), [Table 31](#), [Table 32](#), and [Table 33](#) provide the "diode" parameter and interface specifications. Two different sets of "diode" parameters are listed in [Table 30](#) and [Table 31](#). The Diode Model parameters ([Table 30](#)) apply to traditional thermal sensors that use the Diode Equation to determine the



processor temperature. Transistor Model parameters (Table 31) have been added to support thermal sensors that use the transistor equation method. The Transistor Model may provide more accurate temperature measurements when the diode ideality factor is closer to the maximum or minimum limits. This thermal "diode" is separate from the Thermal Monitor's thermal sensor and cannot be used to predict the behavior of the Thermal Monitor.

Table 30. Thermal "Diode" Parameters using Diode Model

Symbol	Parameter	Min	Typ	Max	Unit	Notes
I_{FW}	Forward Bias Current	5	—	200	μA	1
n	Diode Ideality Factor	1.000	1.009	1.050	-	2, 3, 4
R_T	Series Resistance	2.79	4.52	6.24	Ω	2, 3, 5

NOTES:

- Intel does not support or recommend operation of the thermal diode under reverse bias.
- Characterized across a temperature range of 50 – 80 °C.
- Not 100% tested. Specified by design characterization.
- The ideality factor, n , represents the deviation from ideal diode behavior as exemplified by the diode equation:

$$I_{FW} = I_S * (e^{qV_D/nkT} - 1)$$

where I_S = saturation current, q = electronic charge, V_D = voltage across the diode, k = Boltzmann Constant, and T = absolute temperature (Kelvin).

- The series resistance, R_T , is provided to allow for a more accurate measurement of the junction temperature. R_T , as defined, includes the lands of the processor but does not include any socket resistance or board trace resistance between the socket and the external remote diode thermal sensor. R_T can be used by remote diode thermal sensors with automatic series resistance cancellation to calibrate out this error term. Another application is that a temperature offset can be manually calculated and programmed into an offset register in the remote diode thermal sensors as exemplified by the equation:

$$T_{error} = [R_T * (N-1) * I_{FWmin}] / [nk/q * \ln N]$$

where T_{error} = sensor temperature error, N = sensor current ratio, k = Boltzmann Constant, q = electronic charge.

Table 31. Thermal "Diode" Parameters using Transistor Model

Symbol	Parameter	Min	Typ	Max	Unit	Notes
I_{FW}	Forward Bias Current	5	—	200	μA	1, 2
I_E	Emitter Current	5	—	200	μA	
n_Q	Transistor Ideality	0.997	1.001	1.005	—	3, 4, 5
Beta		0.391	—	0.760	—	3, 4
R_T	Series Resistance	2.79	4.52	6.24	Ω	3, 6

NOTES:

- Intel does not support or recommend operation of the thermal diode under reverse bias.
- Same as I_{FW} in Table 30.
- Characterized across a temperature range of 50 – 80 °C.
- Not 100% tested. Specified by design characterization.
- The ideality factor, n_Q , represents the deviation from ideal transistor model behavior as exemplified by the equation for the collector current:

$$I_C = I_S * (e^{qV_{BE}/nkT} - 1)$$

Where I_S = saturation current, q = electronic charge, V_{BE} = voltage across the transistor base emitter junction (same nodes as V_D), k = Boltzmann Constant, and T = absolute temperature (Kelvin).

- The series resistance, R_T , provided in the Diode Model Table (Table 30) can be used for more accurate readings as needed.

When calculating a temperature based on thermal diode measurements, a number of parameters must be either measured or assumed. Most devices measure the diode ideality and assume a series resistance and ideality trim value, although some are capable of also measuring the series resistance. Calculating the temperature is then



accomplished using the equations listed under [Table 30](#). In most temperature sensing devices, an expected value for the diode ideality is designed-in to the temperature calculation equation. If the designer of the temperature sensing device assumes a perfect diode the ideality value (also called n_{trim}) will be 1.000. Given that most diodes are not perfect, the designers usually select an n_{trim} value that more closely matches the behavior of the diodes in the processor. If the processors diode ideality deviates from that of n_{trim} , each calculated temperature will be offset by a fixed amount. This temperature offset can be calculated with the equation:

$$T_{error(nf)} = T_{measured} \times (1 - n_{actual}/n_{trim})$$

Where $T_{error(nf)}$ is the offset in degrees C, $T_{measured}$ is in Kelvin, n_{actual} is the measured ideality of the diode, and n_{trim} is the diode ideality assumed by the temperature sensing device.

To improve the accuracy of diode based temperature measurements, a new register (T_{diode_Offset}) has been added to processor that will contain thermal diode characterization data. During manufacturing each processors thermal diode will be evaluated for its behavior relative to a theoretical diode. Using the equation above, the temperature error created by the difference between n_{trim} and the actual ideality of the particular processor will be calculated. This value (T_{diode_Offset}) will be programmed in to the new diode correction MSR and when added to the T_{diode_Base} value can be used to correct temperatures read by diode based temperature sensing devices.

If the n_{trim} value used to calculate T_{diode_Offset} differs from the n_{trim} value used in a temperature sensing device, the $T_{error(nf)}$ may not be accurate. If desired, the T_{diode_Offset} can be adjusted by calculating n_{actual} and then recalculating the offset using the actual n_{trim} as defined in the temperature sensor manufacturers' datasheet.

The Diode_Base value and n_{trim} used to calculate the Diode_Correction_Offset are listed in [Table 32](#).

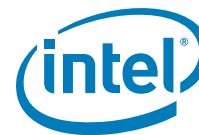
Table 32. Thermal "Diode" n_{trim} and Diode_Correction_Offset

Symbol	Parameter		Unit
n_{trim}	Diode ideality used to calculate Diode_Offset	1.008	—
Diode_Base		0	°C

Table 33. Thermal Diode Interface

Signal Name	Land Number	Signal Description
THERMDA	AL1	diode anode
THERMDC	AK1	diode cathode





6 Features

6.1 Power-On Configuration Options

Several configuration options can be configured by hardware. The Pentium 4 processor samples the hardware configuration at reset, on the active-to-inactive transition of RESET#. For specifications on these options, refer to Table 34.

The sampled information configures the processor for subsequent operation. These configuration options cannot be changed except by another reset. All resets reconfigure the processor; for reset purposes, the processor does not distinguish between a "warm" reset and a "power-on" reset.

Table 34. Power-On Configuration Option Signals

Configuration Option	Signal ^{1,2}
Output tristate	SMI#
Execute BIST	INIT#
In Order Queue pipelining (set IOQ depth to 1)	A7#
Disable MCERR# observation	A9#
Disable BINIT# observation	A10#
APIC Cluster ID (0-3)	A[12:11]#
Disable bus parking	A15#
Disable Hyper-Threading Technology	A31#
Symmetric agent arbitration ID	BRO#
RESERVED	A[6:3]#, A8#, A[14:13]#, A[16:35]#

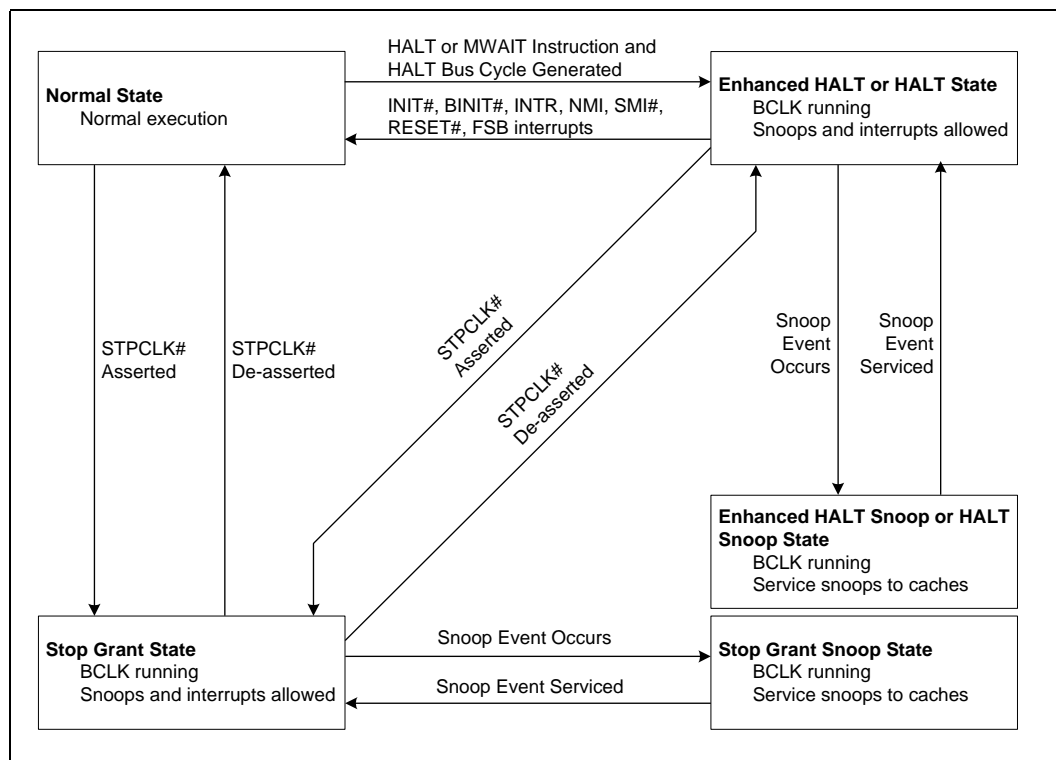
NOTES:

1. Asserting this signal during RESET# will select the corresponding option.
2. Address signals not identified in this table as configuration options should not be asserted during RESET#.

6.2 Clock Control and Low Power States

The processor allows the use of AutoHALT and Stop-Grant states to reduce power consumption by stopping the clock to internal sections of the processor, depending on each particular state. See Figure 16 for a visual representation of the processor low power states.

Figure 16. Processor Low Power State Machine



6.2.1 Normal State

This is the normal operating state for the processor.

6.2.2 HALT and Enhanced HALT Powerdown States

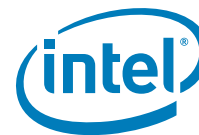
The Pentium 4 processor supports the HALT or Enhanced HALT powerdown state. The Enhanced HALT Powerdown state is configured and enabled via the BIOS. The Enhanced HALT state must be enabled via the BIOS for the processor to remain within its specifications.

The Enhanced HALT state is a lower power state as compared to the Stop Grant State.

If Enhanced HALT is not enabled, the default Powerdown state entered will be HALT. Refer to the following sections for details about the HALT and Enhanced HALT states.

6.2.2.1 HALT Powerdown State

HALT is a low power state entered when all the logical processors have executed the HALT or MWAIT instructions. When one of the logical processors executes the HALT instruction, that logical processor is halted; however, the other processor continues normal operation. The processor will transition to the Normal state upon the occurrence of SMI#, BINIT#, INIT#, or LINT[1:0] (NMI, INTR). RESET# will cause the processor to immediately initialize itself.



The return from a System Management Interrupt (SMI) handler can be to either Normal Mode or the HALT Power Down state. See the *Intel® 64 and IA-32 Architecture Software Developer's Manual, Volume III: System Programmer's Guide* for more information.

The return from a System Management Interrupt (SMI) handler can be to either Normal Mode or the HALT Power Down state. See the *Intel® 64 and IA-32 Architecture Software Developer's Manual, Volume III: System Programmer's Guide* for more information.

The system can generate a STPCLK# while the processor is in the HALT Power Down state. When the system de-asserts the STPCLK# interrupt, the processor will return execution to the HALT state.

While in HALT Power Down state, the processor will process bus snoops.

6.2.2.2 Enhanced HALT Powerdown State

Enhanced HALT is a low power state entered when all logical processors have executed the HALT or MWAIT instructions and Enhanced HALT has been enabled via the BIOS. When one of the logical processors executes the HALT instruction, that logical processor is halted; however, the other processor continues normal operation.

The processor will automatically transition to a lower frequency and voltage operating point before entering the Enhanced HALT state. Note that the processor FSB frequency is not altered; only the internal core frequency is changed. When entering the low power state, the processor will first switch to the lower bus ratio and then transition to the lower VID.

While in Enhanced HALT state, the processor will process bus snoops.

The processor exits the Enhanced HALT state when a break event occurs. When the processor exits the Enhanced HALT state, it will first transition the VID to the original value and then change the bus ratio back to the original value.

6.2.3 Stop Grant State

When the STPCLK# signal is asserted, the Stop Grant state of the processor is entered 20 bus clocks after the response phase of the processor-issued Stop Grant Acknowledge special bus cycle.

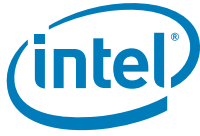
Since the GTL+ signals receive power from the FSB, these signals should not be driven (allowing the level to return to V_{TT}) for minimum power drawn by the termination resistors in this state. In addition, all other input signals on the FSB should be driven to the inactive state.

BINIT# will not be serviced while the processor is in Stop Grant state. The event will be latched and can be serviced by software upon exit from the Stop Grant state.

RESET# causes the processor to immediately initialize itself, but the processor will stay in Stop-Grant state. A transition back to the Normal state will occur with the de-assertion of the STPCLK# signal.

A transition to the Grant Snoop state will occur when the processor detects a snoop on the FSB (see [Section 6.2.4](#)).

While in the Stop-Grant State, SMI#, INIT#, BINIT#, and LINT[1:0] will be latched by the processor, and only serviced when the processor returns to the Normal State. Only one occurrence of each event will be recognized upon return to the Normal state.



While in Stop-Grant state, the processor will process a FSB snoop.

6.2.4 Enhanced HALT Snoop or HALT Snoop State, Stop Grant Snoop State

The Enhanced HALT Snoop State is used in conjunction with the new Enhanced HALT state. If Enhanced HALT state is not enabled in the BIOS, the default Snoop State entered will be the HALT Snoop State. Refer to the following sections for details on HALT Snoop State, Grant Snoop State and Enhanced HALT Snoop State.

6.2.4.1 HALT Snoop State, Stop Grant Snoop State

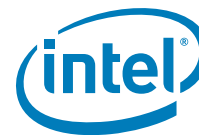
The processor will respond to snoop transactions on the FSB while in Stop-Grant state or in HALT Power Down state. During a snoop transaction, the processor enters the HALT Snoop State: Stop Grant Snoop state. The processor will stay in this state until the snoop on the FSB has been serviced (whether by the processor or another agent on the FSB). After the snoop is serviced, the processor will return to the Stop Grant state or HALT Power Down state, as appropriate.

6.2.4.2 Enhanced HALT Snoop State

The Enhanced HALT Snoop State is the default Snoop State when the Enhanced HALT state is enabled via the BIOS. The processor will remain in the lower bus ratio and VID operating point of the Enhanced HALT state.

While in the Enhanced HALT Snoop State, snoops are handled the same way as in the HALT Snoop State. After the snoop is serviced the processor will return to the Enhanced HALT state.

§ §

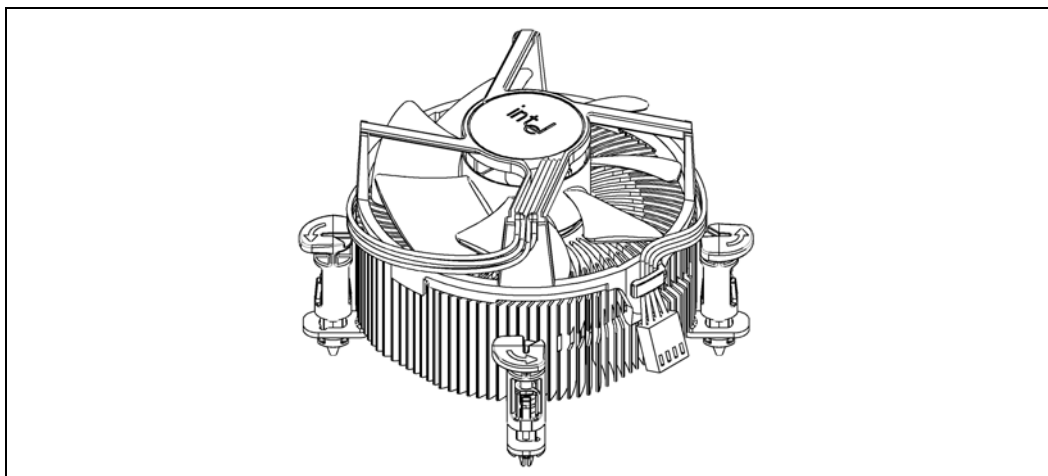


7 Boxed Processor Specifications

The Intel Pentium 4 processor will also be offered as an Intel boxed processor. Intel boxed processors are intended for system integrators who build systems from baseboards and standard components. The boxed Pentium 4 processor will be supplied with a cooling solution. This chapter documents baseboard and system requirements for the cooling solution that will be supplied with the boxed Pentium 4 processor. This chapter is particularly important for OEMs that manufacture baseboards for system integrators. Unless otherwise noted, all figures in this chapter are dimensioned in millimeters and inches [in brackets]. [Figure 17](#) shows a mechanical representation of a boxed Pentium 4 processor.

Note: Drawings in this section reflect only the specifications on the Intel boxed processor product. These dimensions should not be used as a generic keep-out zone for all cooling solutions. It is the system designers' responsibility to consider their proprietary cooling solution when designing to the required keep-out zone on their system platforms and chassis. Refer to the appropriate processor Thermal and Mechanical Design Guidelines (see [Section 1.2](#)) for further guidance.

Figure 17. Mechanical Representation of the Boxed Processor



NOTE: The airflow of the fan heatsink is into the center and out of the sides of the fan heatsink.

7.1 Mechanical Specifications

7.1.1 Boxed Processor Cooling Solution Dimensions

This section documents the mechanical specifications of the boxed Pentium 4 processor. The boxed processor will be shipped with an unattached fan heatsink. [Figure 17](#) shows a mechanical representation of the boxed Pentium 4 processor.

Clearance is required around the fan heatsink to ensure unimpeded airflow for proper cooling. The physical space requirements and dimensions for the boxed processor with assembled fan heatsink are shown in [Figure 18](#) (Side View), and [Figure 19](#) (Top View). The airspace requirements for the boxed processor fan heatsink must also be incorporated into new baseboard and system designs. Airspace requirements are shown in [Figure 23](#) and [Figure 24](#). Note that some figures have centerlines shown (marked with alphabetic designations) to clarify relative dimensioning.

Figure 18. Space Requirements for the Boxed Processor (Side View; applies to all four side views)

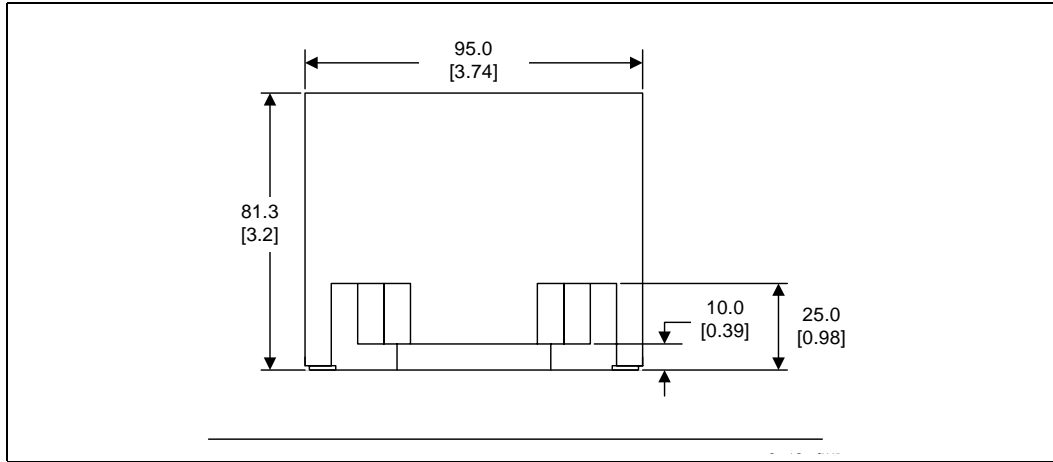
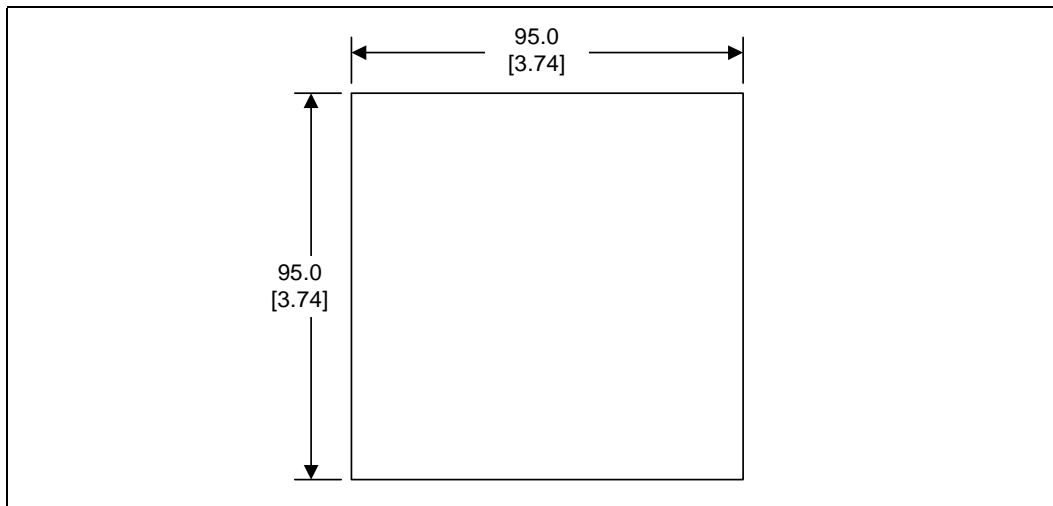


Figure 19. Space Requirements for the Boxed Processor (Top View)



NOTES:

1. The boxed Pentium 4 processor in the 775-land package cooling solution with clip is currently under development and, at this time, is preliminary. The diagrams shown may not reflect the final product.
2. Diagram does not show the attached hardware for the clip design and is provided only as a mechanical representation.

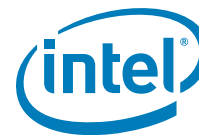
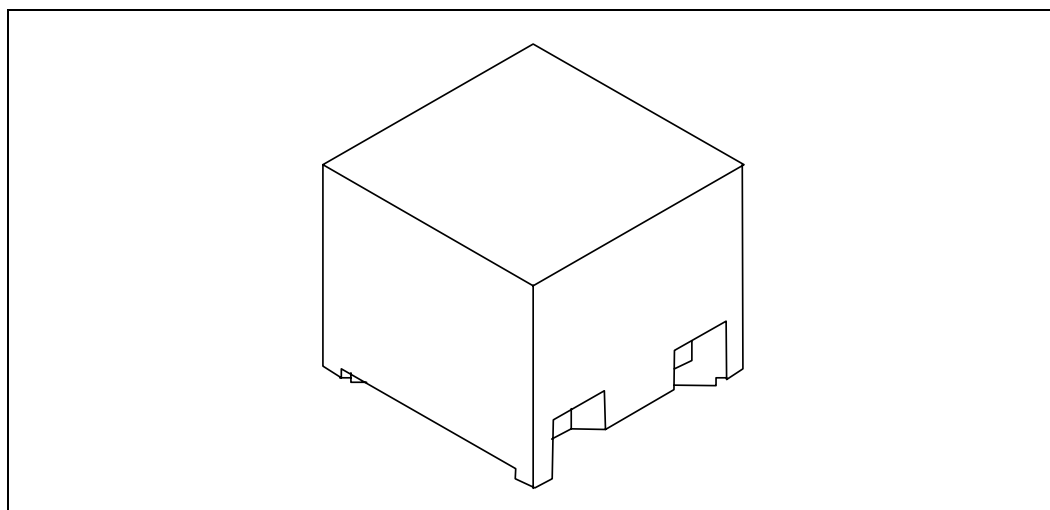


Figure 20. Space Requirements for the Boxed Processor (Overall View)



7.1.2 Boxed Processor Fan Heatsink Weight

The boxed processor fan heatsink will not weigh more than 550 grams. See [Chapter 5](#) and the appropriate processor Thermal and Mechanical Design Guidelines (see [Section 1.2](#)) for details on the processor weight and heatsink requirements.

7.1.3 Boxed Processor Retention Mechanism and Heatsink Attach Clip Assembly

The boxed processor thermal solution requires a heatsink attach clip assembly, to secure the processor and fan heatsink in the baseboard socket. The boxed processor will ship with the heatsink attach clip assembly.

7.2 Electrical Requirements

7.2.1 Fan Heatsink Power Supply

The boxed processor's fan heatsink requires a +12 V power supply. A fan power cable will be shipped with the boxed processor to draw power from a power header on the baseboard. The power cable connector and pinout are shown in [Figure 21](#). Baseboards must provide a matched power header to support the boxed processor. [Table 35](#) contains specifications for the input and output signals at the fan heatsink connector. The fan heatsink outputs a SENSE signal, which is an open-collector output that pulses at a rate of two pulses per fan revolution. A baseboard pull-up resistor provides V_{OH} to match the system board-mounted fan speed monitor requirements, if applicable. Use of the SENSE signal is optional. If the SENSE signal is not used, pin 3 of the connector should be tied to GND.

The fan heatsink receives a PWM signal from the motherboard from the fourth pin of the connector labeled as CONTROL.

Note: The boxed processor's fan heatsink requires a constant +12 V supplied to pin 2 and does not support variable voltage control or 3-pin PWM control.

The power header on the baseboard must be positioned to allow the fan heatsink power cable to reach it. The power header identification and location should be documented in the platform documentation, or on the system board itself. Figure 22 shows the location of the fan power connector relative to the processor socket. The baseboard power header should be positioned within 4.33 inches from the center of the processor socket.

Figure 21. Boxed Processor Fan Heatsink Power Cable Connector Description

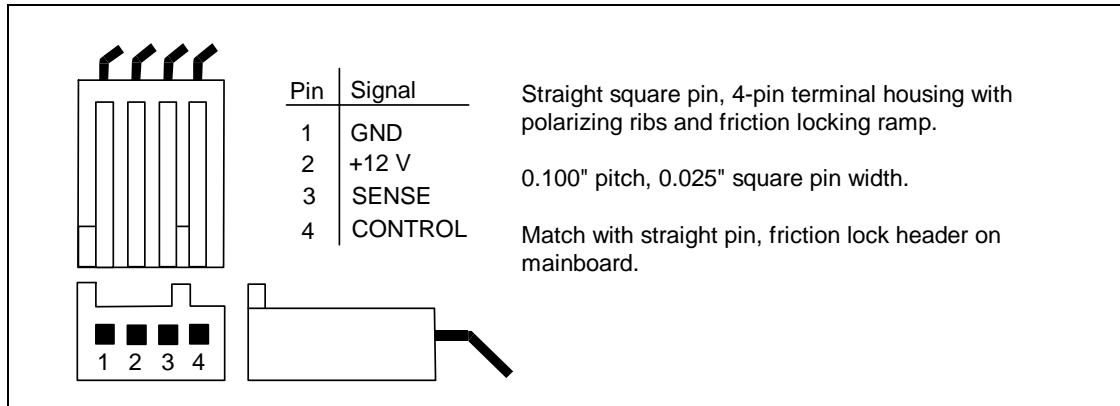


Table 35. Fan Heatsink Power and Signal Specifications

Description	Min	Typ	Max	Unit	Notes
+12 V: 12 volt fan power supply	10.2	12	13.8	V	
IC:					
Peak Fan current draw	—	1.1	1.5	A	
Fan start-up current draw	—	—	2.2	A	
Fan start-up current draw maximum duration	—	—	1.0	Second	
SENSE: SENSE frequency	—	2	—	pulses per fan revolution	1
CONTROL	21	25	28	kHz	2,3

NOTES:

1. Baseboard should pull this pin up to 5 V with a resistor.
2. Open Drain Type, Pulse Width Modulated.
3. Fan will have a pull-up resistor to 4.75 V, maximum 5.25 V.

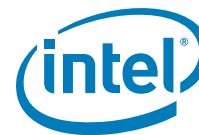
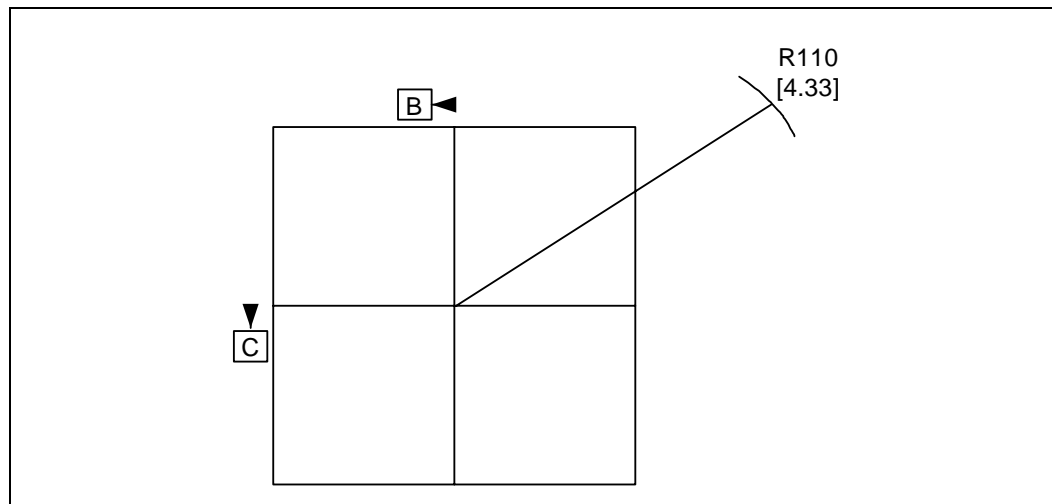


Figure 22. Baseboard Power Header Placement Relative to Processor Socket



7.3 Thermal Specifications

This section describes the cooling requirements of the fan heatsink solution used by the boxed processor.

7.3.1 Boxed Processor Cooling Requirements

The boxed processor may be directly cooled with a fan heatsink. However, meeting the processor's temperature specification is also a function of the thermal design of the entire system, and ultimately the responsibility of the system integrator. The processor temperature specification is in [Chapter 5](#). The boxed processor fan heatsink is able to keep the processor temperature within the specifications in chassis that provide good thermal management. For the boxed processor fan heatsink to operate properly, it is critical that the airflow provided to the fan heatsink is unimpeded. Airflow of the fan heatsink is into the center and out of the sides of the fan heatsink. Airspace is required around the fan to ensure that the airflow through the fan heatsink is not blocked. Blocking the airflow to the fan heatsink reduces the cooling efficiency and decreases fan life. [Figure 23](#) and [Figure 24](#) illustrate an acceptable airspace clearance for the fan heatsink. The air temperature entering the fan should be kept below 38 °C. A Thermally Advantaged Chassis with an Air Guide 1.1 is recommended to meet the 38 °C requirement. Again, meeting the processor's temperature specification is the responsibility of the system integrator.

Note: The processor fan is the primary source of airflow for cooling the V_{CC} voltage regulator. Dedicated voltage regulator cooling components may be necessary if the selected fan is not capable of keeping regulator components below maximum rated temperatures.

Figure 23. Boxed Processor Fan Heatsink Airspace Keep-out Requirements (Side 1 View)

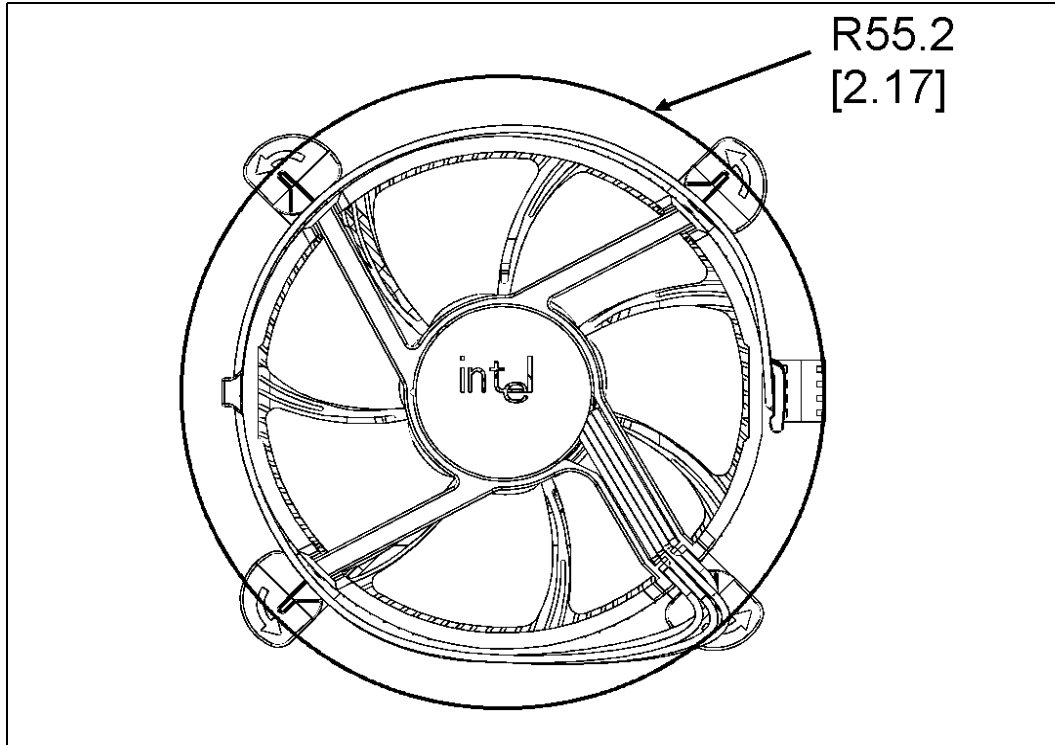
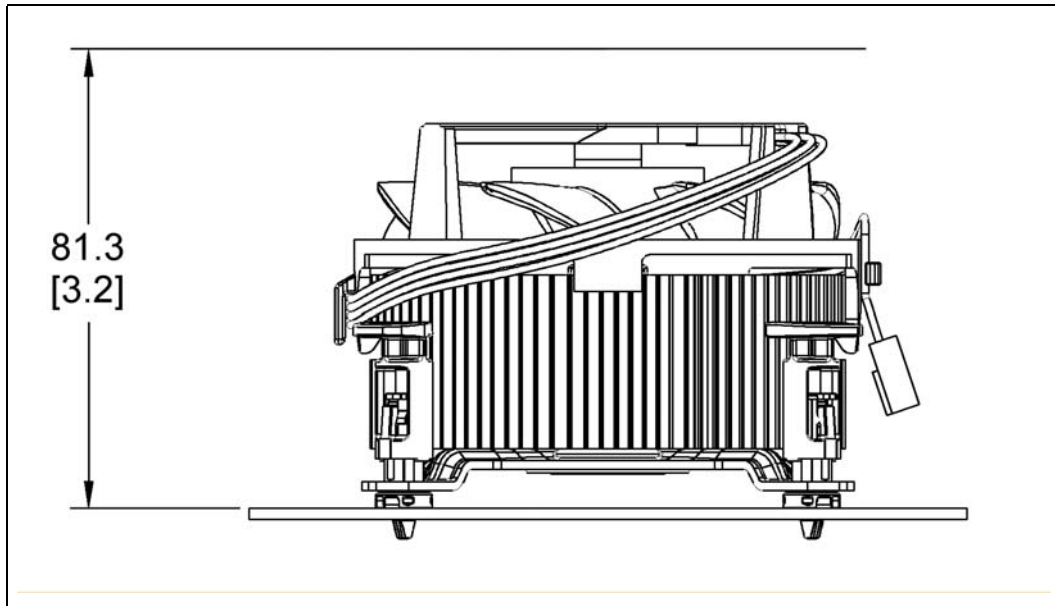
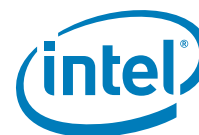


Figure 24. Boxed Processor Fan Heatsink Airspace Keep-out Requirements (Side 2 View)



§ §



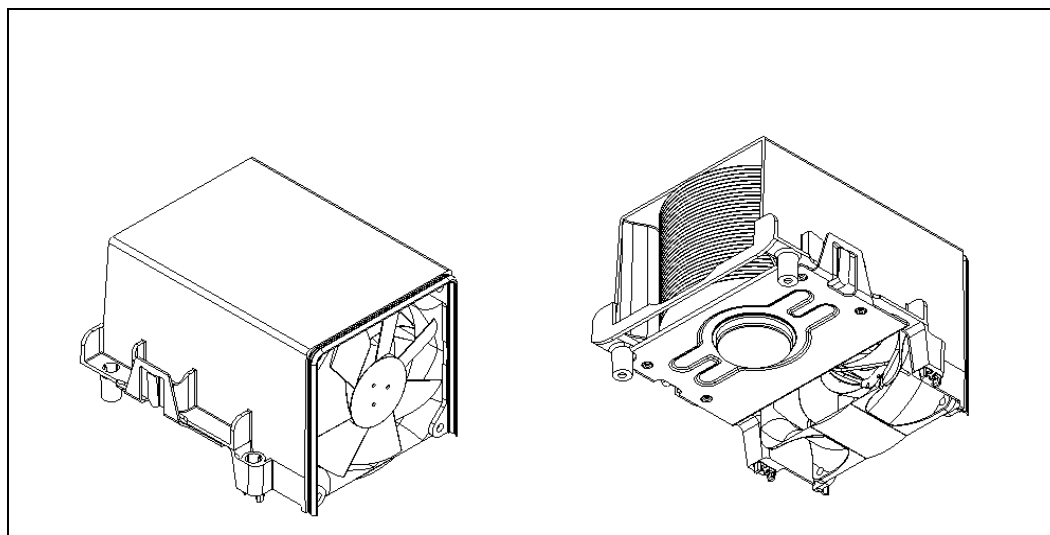
8 *Balanced Technology Extended (BTX) Boxed Processor Specifications*

The Intel Pentium 4 processors will be offered as an Intel boxed processor. Intel boxed processors are intended for system integrators who build systems from largely standard components. The boxed Intel Pentium 4 processor will be supplied with a cooling solution known as the Thermal Module Assembly (TMA). Each processor will be supplied with one of the two available types of TMAs – Type I or Type II. This chapter documents motherboard and system requirements for both the TMAs that will be supplied with the boxed Pentium 4 processor in the 775-land package. This chapter is particularly important for OEMs that manufacture motherboards for system integrators. [Figure 25](#) shows a mechanical representation of a boxed Pentium 4 processor in the 775-land package with a Type I TMA. [Figure 26](#) illustrates a mechanical representation of a boxed Pentium 4 processor in the 775-land package with Type II TMA.

Note: Unless otherwise noted, all figures in this chapter are dimensioned in millimeters and inches [in brackets].

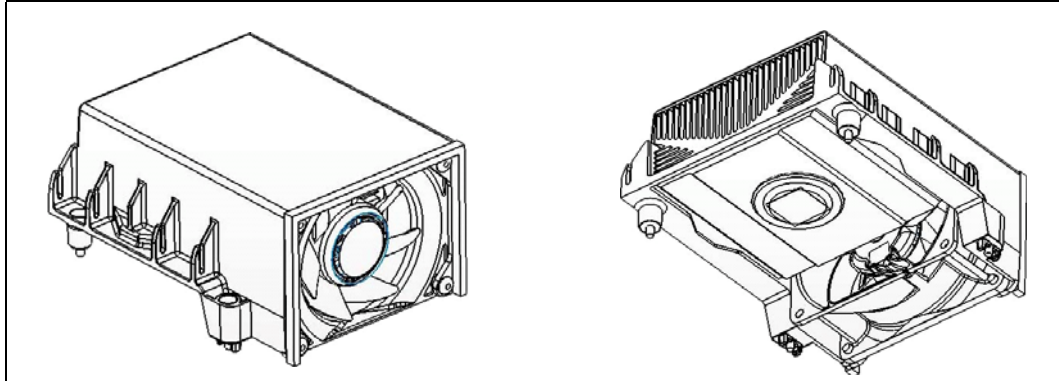
Note: Drawings in this section reflect only the specifications on the Intel boxed processor product. These dimensions should not be used as a generic keep-out zone for all cooling solutions. It is the system designer's responsibility to consider their proprietary cooling solution when designing to the required keep-out zone on their system platforms and chassis. Refer to the appropriate processor Thermal and Mechanical Design Guidelines (see [Section 1.2](#)) for further guidance.

Figure 25. Mechanical Representation of the Boxed Processor with a Type I TMA



NOTE: The duct, clip, heatsink, and fan can differ from this drawing representation but the basic shape and size will remain the same.

Figure 26. Mechanical Representation of the Boxed Processor with a Type II TMA



NOTE: The duct, clip, heatsink and fan can differ from this drawing representation but the basic shape and size will remain the same.

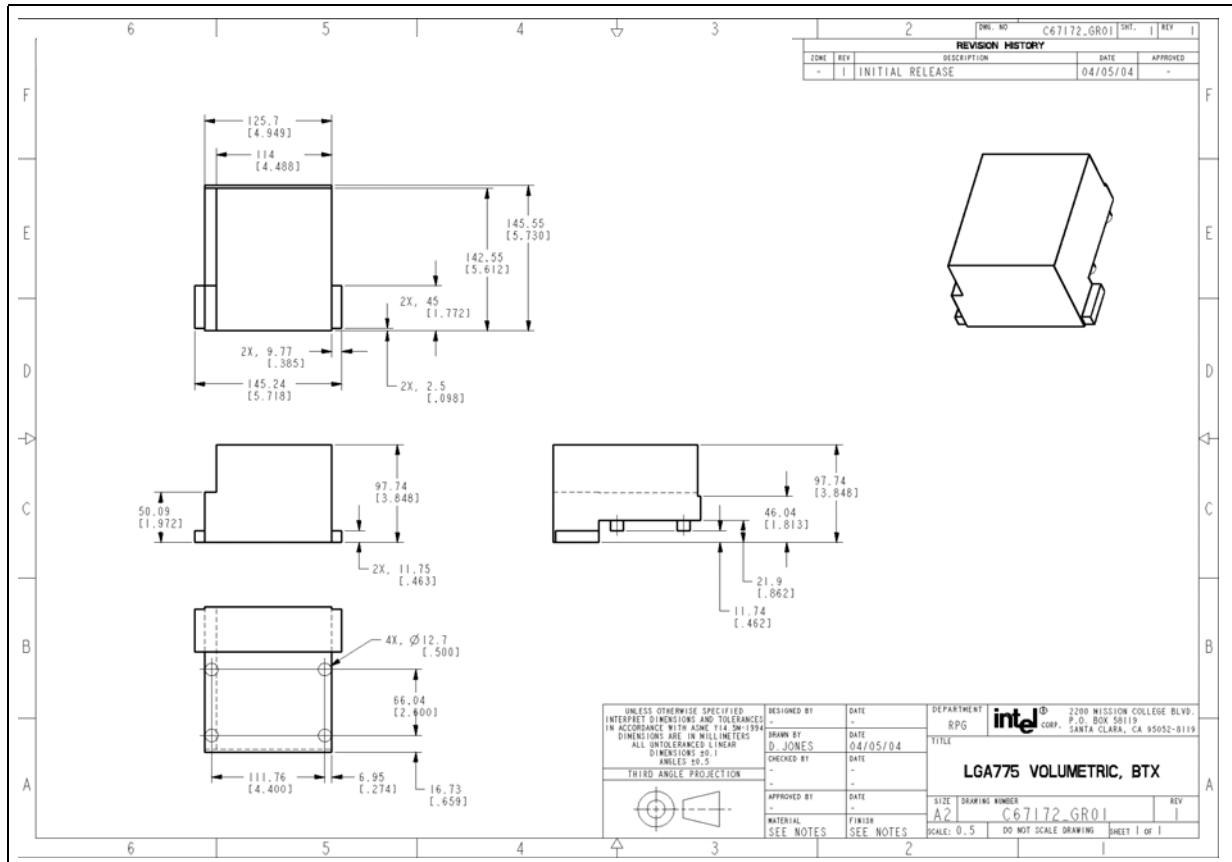
8.1 Mechanical Specifications

8.1.1 Balanced Technology Extended (BTX) Type I and Type II Boxed Processor Cooling Solution Dimensions

This section documents the mechanical specifications of the boxed Intel Pentium 4 processor TMA. The boxed processor will be shipped with an unattached TMA. [Figure 27](#) shows a mechanical representation of the boxed Pentium 4 processor in the 775-land package for Type I TMA. [Figure 28](#) shows a mechanical representation of the boxed Pentium 4 processor in the 775-land package for Type II TMA. The physical space requirements and dimensions for the boxed processor with assembled fan thermal module are shown.

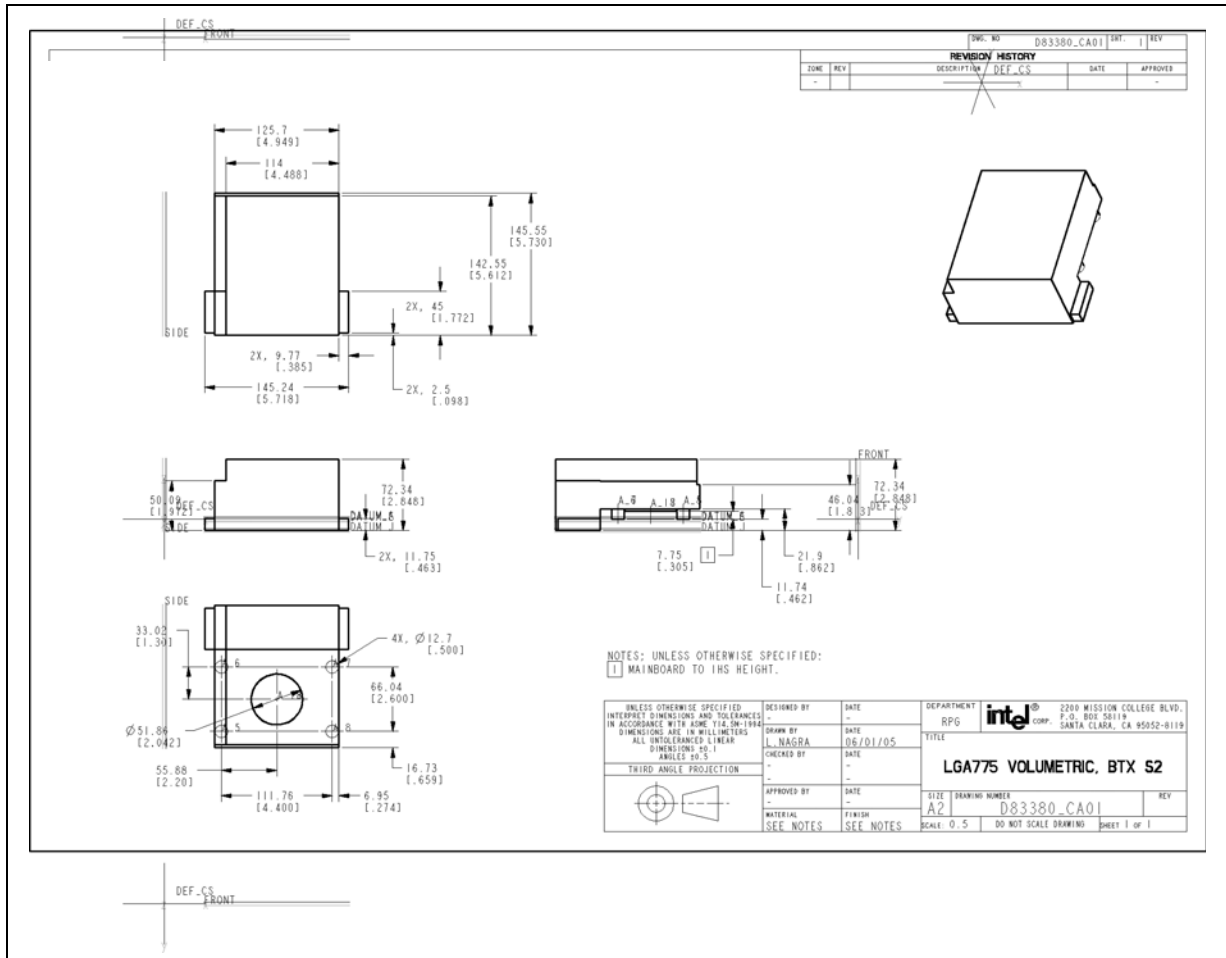


Figure 27. Requirements for the Balanced Technology Extended (BTX) Type I Keep-out Volumes



NOTE: Diagram does not show the attached hardware for the clip design and is provided only as a mechanical representation.

Figure 28. Requirements for the Balanced Technology Extended (BTX) Type II Keep-out Volume



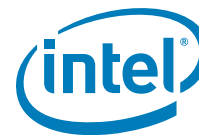
NOTE: Diagram does not show the attached hardware for the clip design and is provided only as a mechanical representation.

8.1.2 Boxed Processor Thermal Module Assembly Weight

The boxed processor thermal module assembly for Type I BTX will not weigh more than 1200 grams. The boxed processor thermal module assembly for Type II BTX will not weigh more than 1200 grams. See Chapter 5 and the appropriate processor Thermal and Mechanical Design Guidelines (see Section 1.2) for details on the processor weight and thermal module assembly requirements.

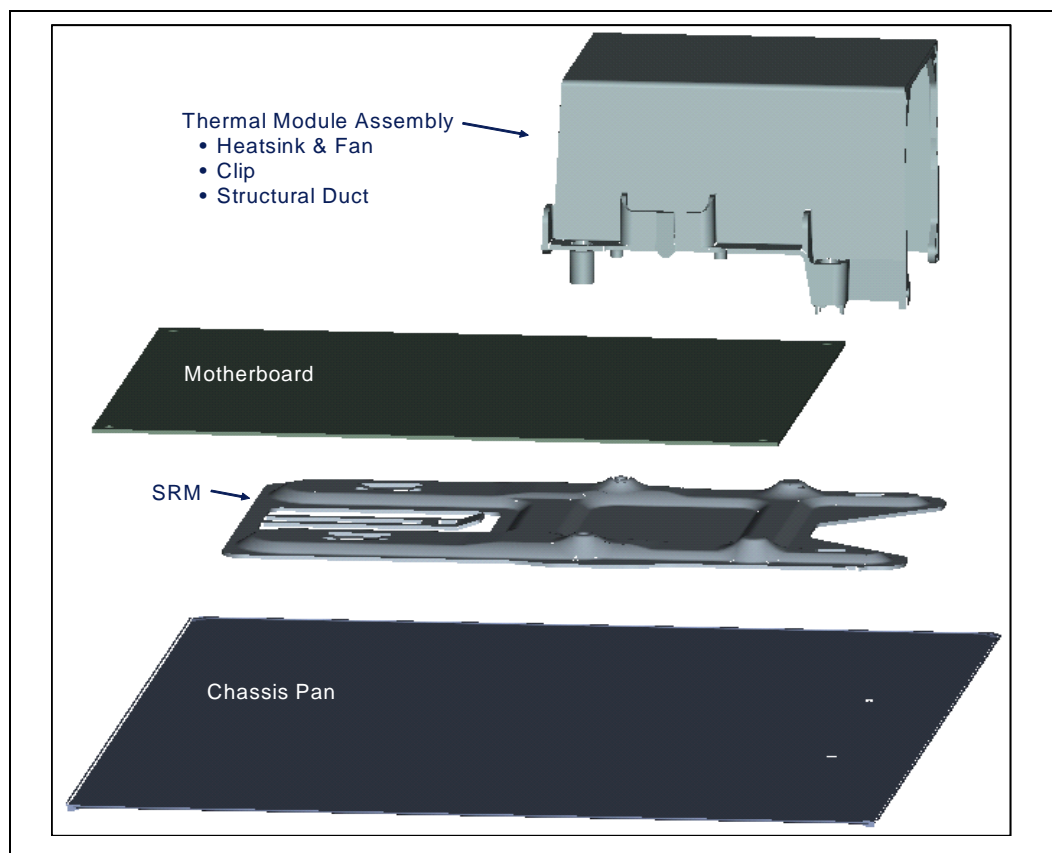
8.1.3 Boxed Processor Support and Retention Module (SRM)

The boxed processor TMA requires an SRM assembly provided by the chassis manufacturer. The SRM provides the attach points for the TMA and provides structural support for the board by distributing the shock and vibration loads to the chassis base pan. The boxed processor TMA will ship with the heatsink attach clip assembly, duct and screws for attachment. The SRM must be supplied by the chassis hardware vendor. See the *Support and Retention Module (SRM) External Design Requirements*



Document, *Balanced Technology Extended (BTX) System Design Guide*, and the appropriate processor Thermal and Mechanical Design Guidelines (see [Section 1.2](#)) for more detailed information regarding the support and retention module and chassis interface and keepout zones. [Figure 29](#) illustrates the assembly stack including the SRM.

Figure 29. Assembly Stack Including the Support and Retention Module



8.2 Electrical Requirements

8.2.1 Thermal Module Assembly Power Supply

The boxed processor's Thermal Module Assembly (TMA) requires a +12 V power supply. The TMA will include power cable to power the integrated fan and will plug into the 4-wire fan header on the baseboard. The power cable connector and pinout are shown in [Figure 30](#). Baseboards must provide a compatible power header to support the boxed processor. [Table 36](#) contains specifications for the input and output signals at the TMA.

The TMA outputs a SENSE signal, which is an open-collector output that pulses at a rate of 2 pulses per fan revolution. A baseboard pull-up resistor provides V_{OH} to match the system board-mounted fan speed monitor requirements, if applicable. Use of the SENSE signal is optional. If the SENSE signal is not used, pin 3 of the connector should be tied to GND.

The TMA receives a Pulse Width Modulation (PWM) signal from the motherboard from the 4th pin of the connector labeled as CONTROL.

Note: The boxed processor's TMA requires a constant +12 V supplied to pin 2 and does not support variable voltage control or 3-pin PWM control.

The power header on the baseboard must be positioned to allow the TMA power cable to reach it. The power header identification and location should be documented in the platform documentation, or on the system board itself. Figure 31 shows the location of the fan power connector relative to the processor socket. The baseboard power header should be positioned within 4.33 inches from the center of the processor socket.

Figure 30. Boxed Processor TMA Power Cable Connector Description

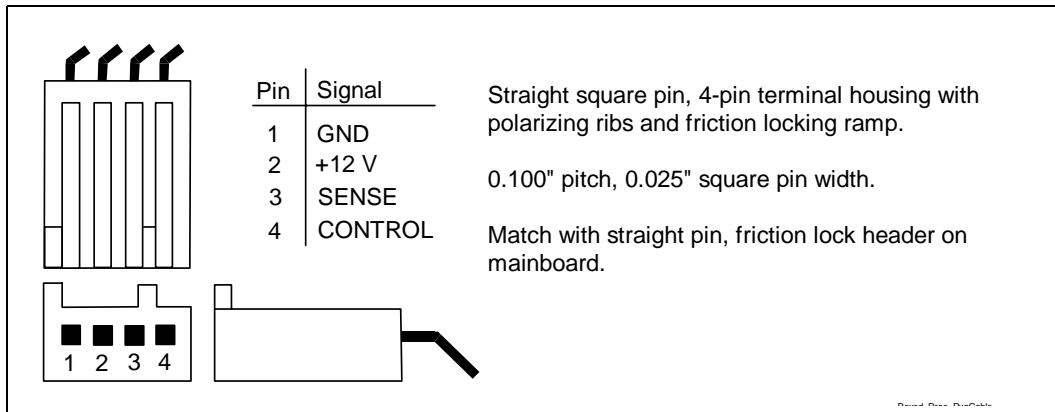


Table 36. TMA Power and Signal Specifications

Description	Min	Typ	Max	Unit	Notes
+12 V: 12 volt fan power supply	10.2	12	13.8	V	
IC:					
Peak Fan current draw	—	1.0	1.5	A	
Fan start-up current draw	—	—	2.0	A	
Fan start-up current draw maximum duration	—	—	1.0	Second	
SENSE: SENSE frequency	—	2	—	pulses per fan revolution	1
CONTROL	21	25	28	kHz	2,3

NOTES:

1. Baseboard should pull this pin up to 5 V with a resistor.
2. Open Drain Type, Pulse Width Modulated.
3. Fan will have a pull-up resistor to 4.75 V, maximum 5.25 V.

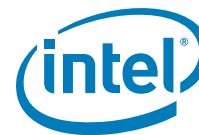
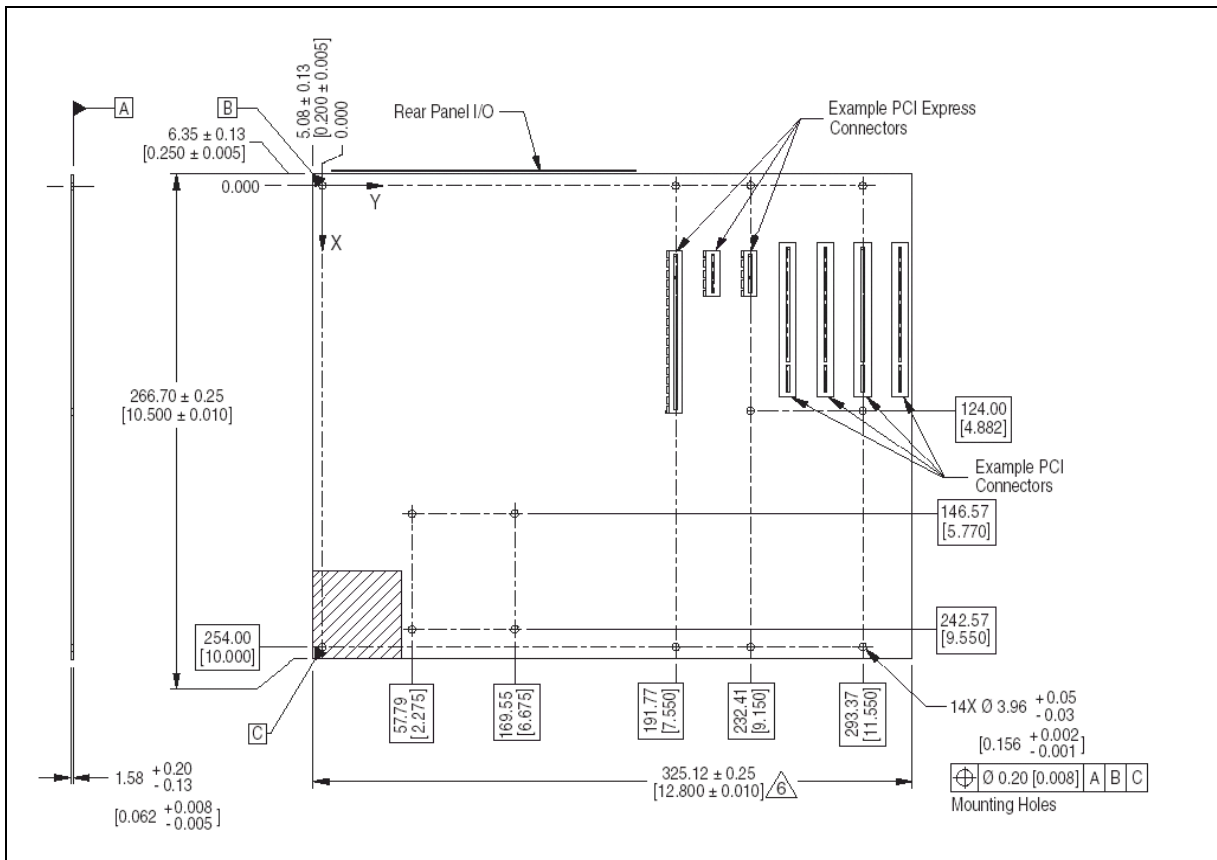


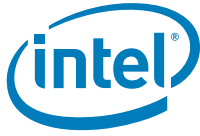
Figure 31. Balanced Technology Extended (BTX) Mainboard Power Header Placement (Hatched Area)



This section describes the cooling requirements of the thermal module assembly solution used by the boxed processor.

8.3.1 Boxed Processor Cooling Requirements

The boxed processor may be directly cooled with a TMA. However, meeting the processor's temperature specification is also a function of the thermal design of the entire system, and ultimately the responsibility of the system integrator. The processor case temperature specification is in Chapter 5. The boxed processor TMA is able to keep the processor temperature within the specifications in Table 26 for chassis that provide good thermal management. For the boxed processor TMA to operate properly, it is critical that the airflow provided to the TMA is unimpeded. Airflow of the TMA is into the duct and out of the rear of the duct in a linear flow. Blocking the airflow to the TMA inlet reduces the cooling efficiency and decreases fan life. Filters will reduce or impede airflow which will result in a reduced performance of the TMA. The air temperature entering the fan should be kept below 35.5°C. Again, meeting the processor's temperature specification is the responsibility of the system integrator.



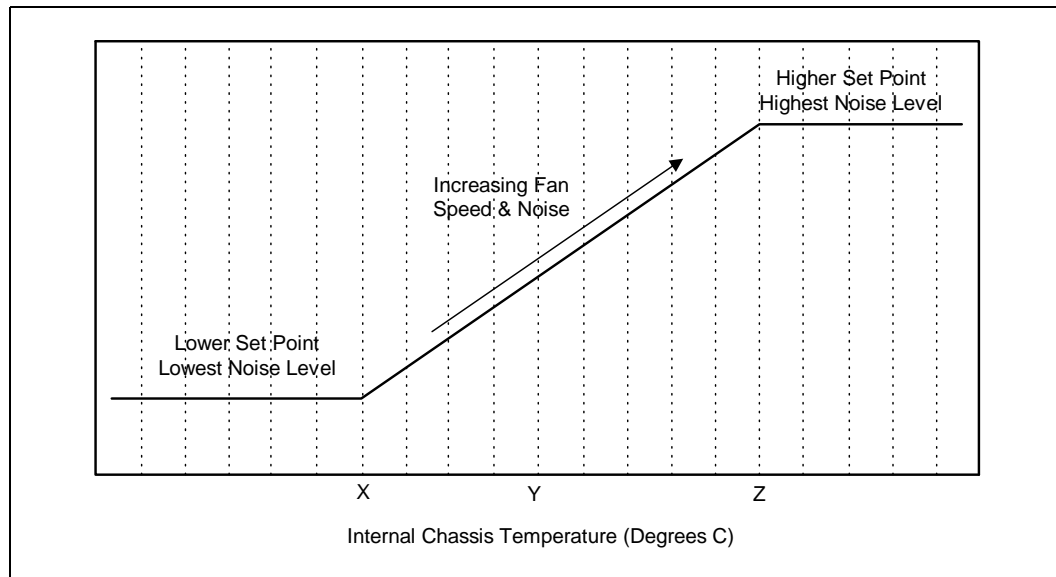
In addition, Type I TMA must be used with Type I chassis only and Type II TMA with Type II chassis only. Type I TMA will not fit in a Type II chassis due to the height difference. In the event a Type II TMA is installed in a Type I chassis, the gasket on the chassis will not seal against the Type II TMA and poor acoustic performance will occur as a result.

8.3.2 Variable Speed Fan

The boxed processor fan will operate at different speeds over a short range of temperatures based on a thermistor located in the fan hub area. This allows the boxed processor fan to operate at a lower speed and noise level while thermistor temperatures are low. If the thermistor senses a temperatures increase beyond a lower set point, the fan speed will rise linearly with the temperature until the higher set point is reached. At that point, the fan speed is at its maximum. As fan speed increases, so do fan noise levels. These set points are represented in Figure 32 and Table 37. The internal chassis temperature should be kept below 35.5°C. Meeting the processor's temperature specification (see Chapter 5) is the responsibility of the system integrator.

Note: The motherboard must supply a constant +12 V to the processor's power header to ensure proper operation of the variable speed fan for the boxed processor (refer to Table 37) for the specific requirements).

Figure 32. Boxed Processor TMA Set Points



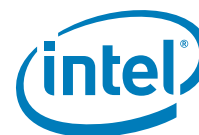


Table 37. TMA Set Points for 3-wire operation of BTX Type I and Type II Boxed Processors

Boxed Processor TMA Set Point (°C)	Boxed Processor Fan Speed	Notes
$X \leq 23$	When the internal chassis temperature is below or equal to this set point, the fan operates at its lowest speed. Recommended maximum internal chassis temperature for nominal operating environment.	1
$Y = 29$	When the internal chassis temperature is at this point, the fan operates between its lowest and highest speeds. Recommended maximum internal chassis temperature for worst-case operating environment.	
$Z \geq 35.5$	When the internal chassis temperature is above or equal to this set point, the fan operates at its highest speed.	1

NOTES:

1. Set point variance is approximately $\pm 1^{\circ}\text{C}$ from Thermal Module Assembly to Thermal Module Assembly.

If the boxed processor TMA 4-pin connector is connected to a 4-pin motherboard header and the motherboard is designed with a fan speed controller with PWM output (see CONTROL in Table 36) and remote thermal diode measurement capability, the boxed processor will operate as described in the following paragraphs.

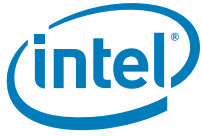
As processor power has increased, the required thermal solutions have generated increasingly more noise. Intel has added an option to the boxed processor that allows system integrators to have a quieter system in the most common usage.

The 4-wire PWM controlled fan in the TMA solution provides better control over chassis acoustics. It allows better granularity of fan speed and lowers overall fan speed than a voltage-controlled fan. Fan RPM is modulated through the use of an ASIC located on the motherboard that sends out a PWM control signal to the 4th pin of the connector labeled as CONTROL. The fan speed is based on a combination of actual processor temperature and thermistor temperature.

If the 4-wire PWM controlled fan in the TMA solution is connected to a 3-pin baseboard processor fan header it will default back to a thermistor controlled mode, allowing compatibility with existing 3-pin baseboard designs. Under thermistor controlled mode, the fan RPM is automatically varied based on the T_{inlet} temperature measured by a thermistor located at the fan inlet.

For more details on specific motherboard requirements for 4-wire based fan speed control see the appropriate processor Thermal and Mechanical Design Guidelines (see Section 1.2).







9 *Debug Tools Specifications*

9.1 **Logic Analyzer Interface (LAI)**

Intel is working with two logic analyzer vendors to provide logic analyzer interfaces (LAIs) for use in debugging Pentium 4 processor systems. Tektronix and Agilent should be contacted to get specific information about their logic analyzer interfaces. The following information is general in nature. Specific information must be obtained from the logic analyzer vendor.

Due to the complexity of Pentium 4 processor systems, the LAI is critical in providing the ability to probe and capture FSB signals. There are two sets of considerations to keep in mind when designing a Pentium 4 processor system that can make use of an LAI: mechanical and electrical.

9.1.1 **Mechanical Considerations**

The LAI is installed between the processor socket and the processor. The LAI lands plug into the processor socket, while the processor lands plug into a socket on the LAI. Cabling that is part of the LAI egresses the system to allow an electrical connection between the processor and a logic analyzer. The maximum volume occupied by the LAI, known as the keepout volume, as well as the cable egress restrictions, should be obtained from the logic analyzer vendor. System designers must make sure that the keepout volume remains unobstructed inside the system. Note that it is possible that the keepout volume reserved for the LAI may differ from the space normally occupied by the processor heatsink. If this is the case, the logic analyzer vendor will provide a cooling solution as part of the LAI.

9.1.2 **Electrical Considerations**

The LAI will also affect the electrical performance of the FSB; therefore, it is critical to obtain electrical load models from each of the logic analyzers to be able to run system level simulations to prove that their tool will work in the system. Contact the logic analyzer vendor for electrical specifications and load models for the LAI solution it provides.

§ §

