

UNCONTROLLED DOCUMENT

PART NUMBER
SML-LXR851GC-TR

REV.
B

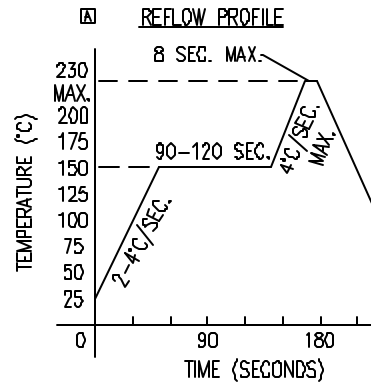
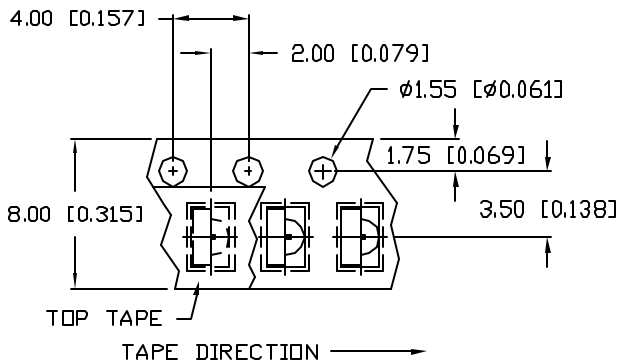
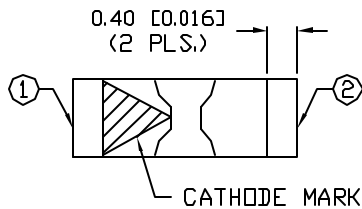
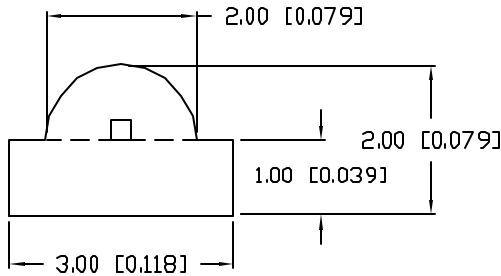
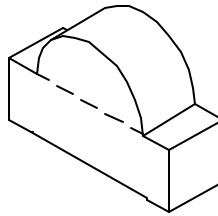
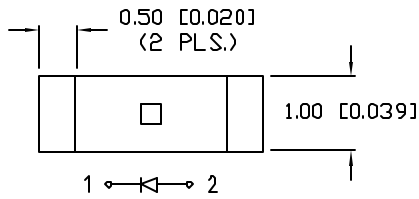

RECOMMENDED PAD LAYOUT

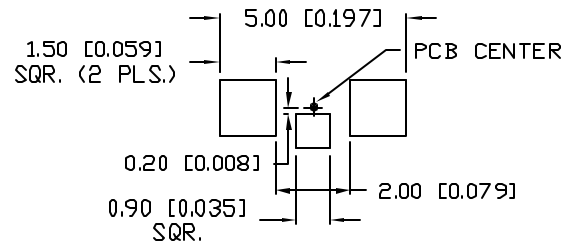

REV.	E.C.N. NUMBER AND REVISION COMMENTS	DATE
A	E.C.N. #10644	7.18.00
B	E.C.N. #10967.	9.07.04

ELECTRO-OPTICAL CHARACTERISTICS $T_A=25^\circ\text{C}$ $I_f=20\text{mA}$

PARAMETER	MIN	TYP	MAX	UNITS	TEST COND
PEAK WAVELENGTH		565		nm	
FORWARD VOLTAGE		2.2	2.6	V_f	
REVERSE VOLTAGE	5.0			V_r	$I_f=100\mu\text{A}$
AXIAL INTENSITY		11		mcd	$I_f=20\text{mA}$
VIEWING ANGLE		160		2x theta	
EMITTED COLOR:	GREEN				
EPOXY LENS FINISH:	WATER CLEAR				

LIMITS OF SAFE OPERATION AT 25°C

PARAMETER	MAX	UNITS
PEAK FORWARD CURRENT*	160	mA
STEADY CURRENT	25	mA
POWER DISSIPATION	100	mW
DERATE FROM 25°C	-1.2	mW/ $^\circ\text{C}$
OPERATING TEMP.	-25 TO +85	$^\circ\text{C}$
STORAGE TEMP.	-30 TO +85	$^\circ\text{C}$

* $t < 10\mu\text{s}$

CAUTION: MOISTURE SENSITIVE DEVICE
PER JEDEC LEVEL 4 STANDARDS

NOTES:

- 2,000 PER REEL.
- THE CATHODE IS ORIENTED TOWARDS THE TAPE SPROCKET HOLE.

UNCONTROLLED DOCUMENT

*UNLESS OTHERWISE SPECIFIED TOLERANCES PER DECIMAL PRECISION ARE: X=±1 (±0.039), XX=±0.5 (±0.020), XXX=±0.25 (±0.010), XXXX=±0.127 (±0.005). LEAD SIZE=±0.05 (0.002), LEAD LENGTH=±0.75 (±0.030), MIN= +0.00 DECIMAL PRECISION -0.00 -DECIMAL PRECISION

REV.	PART NUMBER
B	SML-LXR851GC-TR
1.0mm x 3.0mm PCB RIGHT ANGLE SURFACE MOUNT LED, 565nm GREEN, WATER CLEAR LENS, TAPE AND REEL.	

CONFIDENTIAL INFORMATION
THE INFORMATION CONTAINED IN THIS DOCUMENT IS THE PROPERTY OF LUMEX INC. EXCEPT AS SPECIFICALLY AUTHORIZED IN WRITING BY LUMEX INC., THE HOLDER OF THIS DOCUMENT SHALL KEEP ALL INFORMATION CONTAINED HEREIN CONFIDENTIAL AND SHALL PROTECT SAME IN WHOLE OR IN PART FROM DISCLOSURE AND DISSEMINATION TO ALL THIRD PARTIES.

RELIABILITY NOTE
OUR MANY YEARS OF EXPERIENCE DATA ACCUMULATION INDICATE THAT SOLDER HEAT IS A MAJOR CAUSE OF EARLY AND FUTURE FAILURE. PLEASE PAY ATTENTION TO YOUR SOLDERING PROCESS.

		290 E. HELEN ROAD PALATINE, IL 60067-6976 PHONE: +1.847.359.2790 US WEB: www.lumex.com TW WEB: www.lumex.com.tw
DRAWN BY: ct	CHECKED BY:	APPROVED BY:
DATE: 10.22.98		PAGE: 1 OF 1
SCALE: N/A		