

## Multi-Turn Surface Mount Miniature 1/4" Square Cermet Trimmers, Fully Sealed



The TS63 multiturn trimmer has been designed for use in PCB surface mounting applications.

Three variations are available according to the positioning of the control screw and contact positions.

The cermet track gives a high stability performance with an extended ohmic capacity of 10 Ω to 2 MΩ.

### FEATURES

- 0.25 W at 85 °C
- Industrial grade
- Multi-turn operation
- A low contact resistance variation (down to 2 % Rn)
- Low end contact resistance (1 Ω typical)
- Full sealing
- Tests according to CECC 41 000



### DIMENSIONS in millimeters

#### TS63X

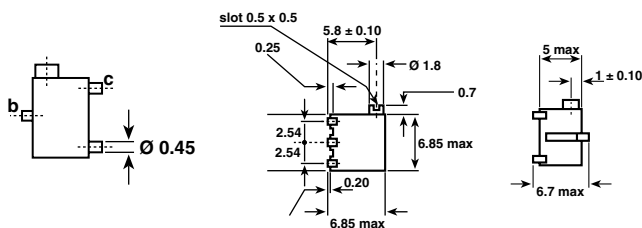

#### RECOMMENDED SOLDERING AREAS

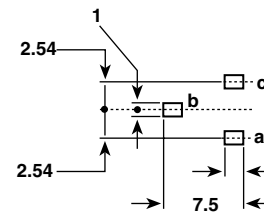

#### TS63Z

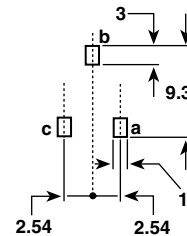
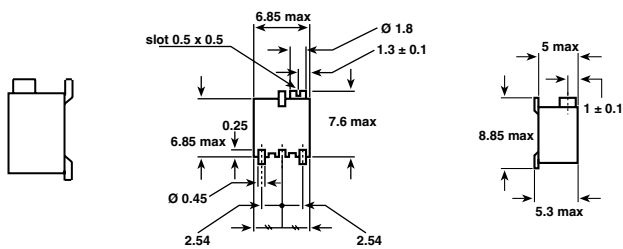

#### TS63Y

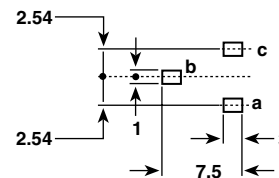
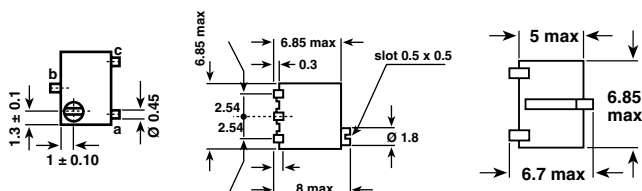

### CIRCUIT DIAGRAM

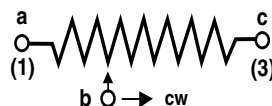

Tolerance unless otherwise specified ± 0.5



Multi-Turn Surface Mount  
Miniature 1/4" Square Cermet Trimmers, Fully Sealed

Vishay Sfernice

ELECTRICAL SPECIFICATIONS		
Resistive Element		Cermet
Electrical Travel		13 turns ± 2
Resistance Range		10 Ω to 2 MΩ
Standard Series		1 - 2 - 5
Tolerance	Standard	± 10 %
	On request	± 5 %
Power Rating	Linear	0.25 W at 85 °C
	Logarithmic	not applicable
Temperature Coefficient		See Standard Resistance Element Data
Limiting Element Voltage (Linear Law)		250 V
Contact Resistance Variation		2 % Rn or 2 Ω
End Resistance (Typical)		1 Ω
Dielectric Strength (RMS)		1000 V
Insulation Resistance		10 <sup>6</sup> MΩ

**MECHANICAL SPECIFICATIONS**

Mechanical Travel	15 turns ± 5
Operating Torque (max. Ncm)	1.5
End Stop Torque	clutch action
Unit Weight (max. g)	0.5
Wiper (actual travel)	Positioned at approx. 50 %

**ENVIRONMENTAL SPECIFICATIONS**

Temperature Range	- 55 °C to + 155 °C
Climatic Category	55/125/56
Sealing	sealed container solder immersion IP67

**POWER RATING CHART**

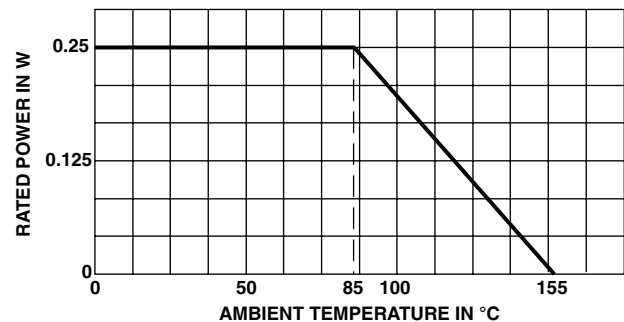

PERFORMANCE						
CECC 41100					TYPICAL VALUES AND DRIFTS	
TESTS	CONDITIONS	$\frac{\Delta RT}{RT}$ (%)	REQUIREMENTS	$\frac{\Delta R_{1-2}}{R_{1-2}}$ (%)	$\frac{\Delta RT}{RT}$ (%)	$\frac{\Delta R_{1-2}}{R_{1-2}}$ (%)
Climatic Sequence	Phase A dry heat 125 °C Phase B damp heat Phase C cold - 55 °C Phase D damp heat 5 cycles	± 2 %		± 3 %	± 0.5 %	± 1 %
Long Term Damp Heat	56 days 40 °C 93 % RH	± 2 %	Dielectric strength: 250 V RMS Insulation resistance: > 100 MΩ	± 3 %	± 0.5 %	± 1 %
Rotational Life (Electrical, Mechanical)	200 cycles at rated power	± 2 %	Contact res. variat.: < 3 % Rn		± (2 % + 3 Ω)	Contact res. variat.: < 1 % Rn
Load Life	1000 h at rated power 90°/30° - ambient temp. 85 °C	± 2 %	Contact res. variat.: < 3 % Rn	± 4 %	± 1 %	± 2 %
Thermal Shock	5 cycles - 55 °C to + 125 °C	± 1.5 %		$\frac{\Delta V_{1-2}}{V_{1-3}}$ ± 1 %	± 0.5 %	$\frac{\Delta V_{1-2}}{V_{1-3}}$ < ± 1 %
Shock	50 g at 11 ms 3 successive shocks in 3 directions	± 1 %		± 2 %	± 0.1 %	± 0.2 %
Vibration	10 - 55 Hz 0.75 mm or 10 g for 6 hours	± 1 %		$\frac{\Delta V_{1-2}}{V_{1-3}}$ ± 2 %	± 0.1 %	$\frac{\Delta V_{1-2}}{V_{1-3}}$ < ± 0.2 %

STANDARD RESISTANCE ELEMENT DATA				
STANDARD RESISTANCE VALUES	LINEAR LAW			TYPICAL TCR - 55 °C + 125 °C ppm/°C
	MAX. POWER AT 85 °C	MAX. WORKING VOLTAGE	MAX. CUR. THROUGH WIPER	
Ω	W	V	mA	
10	0.25 ↓	1.58	158	± 100
20		2.23	112	
50		3.53	77	
100		5.00	50	
200		7.07	35	
500		11.2	22	
1K		15.8	15.8	
2K		22.3	11.2	
5K		35.3	7.1	
10K		50.0	5.0	
20K	70.7	3.5		
25K	79.0	3.2		
50K	112	2.2		
100K	158	1.6		
200K	0.25	224	1.1	
250K	0.25	250	1.1	
500K	0.13	250	0.50	
1M	0.06	250	0.25	
2M	0.03	250	0.125	

**MARKING**

Printed: VISHAY trademark, model, style, ohmic value (in Ω, kΩ, MΩ), tolerance (in %) only if non standard, manufacturing date, marking of terminal 3.

**SOLDERING RECOMMENDATION**

Soldering cycle: 10 s at 220 °C max or with an 40 W iron: 3 s at 350 °C

Soldering is recommended by reflow or vapour phase.

**PACKAGING**

- X, Y and Z types: on tape and reel (Dia. 330 mm) of 500 pieces, code TR500.
- On request in magazine pack by 50 pieces (Tube) code TU.

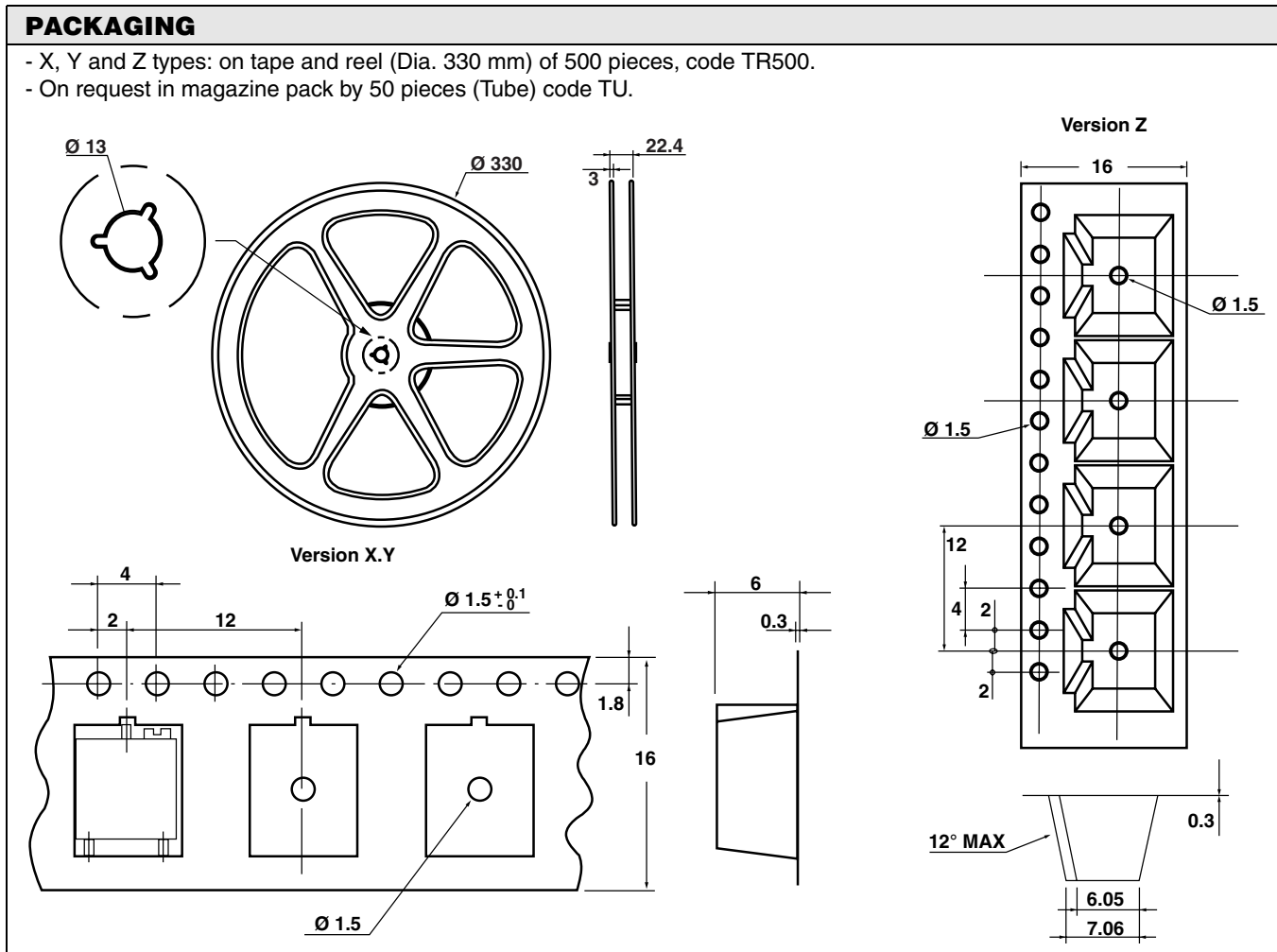



Multi-Turn Surface Mount  
Miniature 1/4" Square Cermet Trimmers, Fully Sealed

Vishay Sfernice

<b>ORDERING INFORMATION</b>					
<b>TS63</b> MODEL	<b>Y</b> STYLE	<b>500 kΩ</b> OHMIC VALUE	<b>± 10 %</b> TOLERANCE	<b>TR500</b> PACKAGING	<b>e3</b> LEAD FINISH
				TR500: Tape and reel On request: TU50: Tube	e3: pure Sn

<b>SAP PART NUMBERING GUIDELINES</b>														
<b>T</b>	<b>S</b>	<b>6</b>	<b>3</b>	<b>Y</b>	<b>5</b>	<b>0</b>	<b>4</b>	<b>K</b>	<b>R</b>	<b>1</b>	<b>0</b>			
MODEL				STYLE	OHMIC VALUE			TOL	PACKAGING CODE		SPECIAL (IF APPLICABLE)			
See the end of this data book for conversion tables														



## Notice

Specifications of the products displayed herein are subject to change without notice. Vishay Intertechnology, Inc., or anyone on its behalf, assumes no responsibility or liability for any errors or inaccuracies.

Information contained herein is intended to provide a product description only. No license, express or implied, by estoppel or otherwise, to any intellectual property rights is granted by this document. Except as provided in Vishay's terms and conditions of sale for such products, Vishay assumes no liability whatsoever, and disclaims any express or implied warranty, relating to sale and/or use of Vishay products including liability or warranties relating to fitness for a particular purpose, merchantability, or infringement of any patent, copyright, or other intellectual property right.

The products shown herein are not designed for use in medical, life-saving, or life-sustaining applications. Customers using or selling these products for use in such applications do so at their own risk and agree to fully indemnify Vishay for any damages resulting from such improper use or sale.